



LEGEND

NEW

New products.

UPDATED

Products updated in colors or graphics with no changes to technical features or specifications.

LIGHT&FAST

Products that stand out for their extreme lightweight.

1ST CLASS

Products with superior points of innovation making them the absolute top of the line.

BEST SELLER

Popular products that typically strike a fine balance between performance and price.

LADY

Products designed specifically for women.

JUNIOR

Products designed specifically for children.

SKI COMP

Products designed for ski mountaineering competitions. Usually the lightest and fastest in the world.

CC4U

C.A.M.P. cares for you: special markings for ice axes and crampons to show when points are dull beyond their safe limit.

PAT. PEND.

Products that have a utility patent application.

DESIGN PAT. PEND.

Products that have a design patent application.

INDEX

ICE AXES	5
Technical Ice	9
Mountaineering	11
CRAMPONS	19
Technical Ice	23
Mountaineering	25
Ski Mountaineering	30
TRACTION	35
ICE SCREWS	43
POLES	47
Telescoping	51
Fixed	56
Foldable	57
ROCK PROTECTION	63
PITONS	71
CARABINERS & QUICKDRAWS	79
Carabiners	86
Quickdraws	104
ANCHORING DEVICES AND WEBBING	117
Anchoring webbings	121
Multiple anchoring devices	123
ROPE TOOLS	127
Descenders and belay devices	131
Ascenders	133
Devices for confined spaces	138
Pulleys	138
Ropes Courses	145
ROPES	149
Dynamic ropes	153
Semi-static ropes	156
Accessory Cords	158
HARNESSES	159
Climbing	165
Alpinism-Ski Mountaineering	173
Groups	175
Chest harnesses	175
Junior	176
CHALK BAGS & CHALK	177
BOULDERING	187
HELMETS	191
VIA FERRATA	201
Lanyards	205
Via Ferrata Kits	207
Via Ferrata Gloves	208
PACKS	209
Mountaineering	213
Climbing	218
Ski Mountaineering	219
Trail Multisport	224
ESSENTIAL LINE	231
Essential winter outerwear	237
Essential sleeping bags	250
Essential equipment	252
WINTER GLOVES	259
Geko Line	264
G Line	267
Air Line	272
K Line	275
Mitt'N Line	276
PROMOTIONALS	279

AUTHENTIC MOUNTAIN CULTURE

To say everything in one word ... is it possible? No, but acronyms get us a step closer. Acronyms are all around us and so many lose their meanings over time as their effectiveness makes them a kind of word on their own. So much so that we come to forget their meanings and their origins. It is a shame because historic acronyms often contain a rich summary of the events, places, characters and ideas of the company or the entity or the idea they characterize.

C.A.M.P. is an acronym that stands for four words: *Costruzione Articoli Montagna Premana* which translates to *Construction Articles Mountains Premana*. These words ... and precisely these words ... perfectly define the soul of the unique reality that is C.A.M.P. both today and throughout the company history since 1889. Here we take a moment to go behind each word and the acronym in total to remember its roots, its relevance still today and its promise for the future.

Costruzione (*Construction*). Nicola Codega with his forge and wrought iron embodied the culture of crafting, creating and manufacturing in its purest form at the local level. From that workshop (which still exists in Premana) came everyday objects for residents of the village and the valley below. At the beginning of the twentieth century, the business passed to Nicola's son Antonio who went looking for new possibilities beyond utility items and beyond the Valsassina valley. In 1920, first by bicycle, then by train, he traveled to Lecco and then to Milan with six ice axes for the Brigatti shop. It was a few pieces that would be followed by three thousand for the Italian Alpine Corps. Then in the 1930's as Riccardo Cassin ushered in the next level of climbing and alpinism, he met with Antonio Codega to ask him to build his ice axes and the rest is history as C.A.M.P. would evolve into a company committed to top level products for climbers and alpinists.

Articoli (*Articles*). The evolution takes definitive form with the third generation of the Codega family owners as the brothers Orazio, Nicolino, Samuele and Benedetto (the four sons of Antonio Codega) establish close

relationships with top level international mountaineers and collaborate to design and build the equipment to help them achieve their objectives. Products like the Hummingbird ice axe, Footfang crampons, Tricams, and so many lightweight evolutions help take climbing and alpinism to the next level along with famous names like Greg Lowe, Renato Casarotto, Jerzy Kukuczka and the 'three Patricks' -- Patrick Gabarrou, Patrick Berhault and Patrick Edlinger. Lightweight becomes an essential design element for elite climbers and alpinists to help them move faster and safer in big mountain terrain and C.A.M.P. has kept lightweight in its DNA with a deep focus on lightweight designs using advanced materials and technologies to continue the evolution.

Montagna (*Mountains*). C.A.M.P. is a company where products are at the center and they are conceived in the very place where they are used ... the mountains. From the Alps to the Himalayas, from Alaska to Patagonia: a profound culture runs through these high places where mountaineering and alpinism are practiced and where C.A.M.P. is part of the common denominator fueling the dreams of the climbers who share this intimate culture and spirit of adventure. From an ancient village to high peaks around the world to every kind of verticality. This is the evolution of C.A.M.P. Now present in 80 countries on all continents in every kind of mountain terrain and on every kind of vertical structure also with the innovative Work line of equipment that is now firmly part of the evolution of the developing world of work at heights.

Premana. To get to Premana, one must wind up miles of narrow, steep valleys and when you arrive, moving around requires good breath and strong legs. The fourth generation continues to operate C.A.M.P. from this remote village. The village is the leitmotif of the C.A.M.P. story now more than 130 years old. As in the past, Premana remains a place where you do not pass, you arrive -- because there are no roads out of the back of the town ... only mountains. Premana is a place where craftsmanship has evolved into industry, but also a place where the latter has not canceled the first and the two elements of the unique piece and quality mass production engage, cooperate and converse with each other like young and old. Here are the people and the place of C.A.M.P. and the home of the acronym that means even more today than it did in 1889.

Carlo Caccia
journalist and text editor of C.A.M.P.



Costruzione



Articoli



Montagna



Premana

THE VALUE OF CONTACT



After a long interlude we returned to travel and meeting regularly in person. We had almost lost the habit of it and it has been nice to meet again, talk face to face, exchange experiences about these objectively difficult years in person, and take stock of the situation. We have rediscovered the value of these authentic and enriching interactions in a market that still values direct contact. The context has certainly changed, it presents numerous new challenges, but it is positive to note that the human dimension remains the same.

We talk about products, which are our passion, but also about distribution and supply chain, which act as a link between us and the millions of customers around the world. And of course, we talk about the uniqueness of our company, whose recent rebranding project has managed to truly represent our essence and captivate our customers. We have underlined the importance of working in a context of stability and security which have always been essential features of C.A.M.P.'s offer to its customers and stakeholders. Anyone who knows us knows how focused we are on these aspects and how they set us apart. It was for this reason that C.A.M.P. was recognized among the "Imprese Champions 2023" ... an award assigned by the ItalyPost study center in collaboration with the "Corriere della Sera" (the most prestigious Italian newspaper) that is presented at the Milan Stock Exchange to one thousand Italian companies of any size and sector that have grown the most in the last six years.

However, we have never looked at prizes as a target to reach. Rather, we continue to see them as stimuli to do even better and to continue strong on our path of 'Responsible Evolution'. This is the title we have chosen for our social responsibility and sustainability program that represents a new challenge for us in form, but not in substance, given that we have been operating for over 130 years in a real mountain context, far from major communication routes ... a place in theory with unfavorable conditions for doing business in the modern context. Ours is a vision with ancient roots where the new program integrates perfectly. We are happy now to have a platform to be able to organize, share and communicate our approach to these issues in a more organic way.

There are five pillars, each essential to the other, in which we will invest our commitment and our resources: governance, people, community, environment and products. Governance embodies the choices that each company makes to perpetuate its existence and development over time. In turn, such choices cannot forget people, who represent the protagonists of our history and the community in which we are rooted. The environment is our source of inspiration and our products. Our products are focused on the environments of verticality and we are committed to carrying the torch as a responsible stakeholder and champion of the sustainable intersection of industry and the natural environment from past to present to future.

This catalog brings these five pillars that are behind each of our products into focus. To truly experience them, though, requires in person contact with them ... with the ideas behind, with the people and the community, with the environments of verticality, and with the products themselves. More than ever, we look forward to these meetings and experiences.

Eddy Codega
President

NEWS 2024

Carabiners & Quickdraws



PHOTON LOCK
2931
Pag. 88



PHOTON LOCK
2931
Pag. 88

UPDATED



PHOTON LOCK 3 PACK
3433
Pag. 88



NIMBUS LOCK
2927
Pag. 94



NIMBUS LOCK 3 PACK
3434
Pag. 94



DYON EXPRESS KS
3445/2466
Pag. 104



DYON EXPRESS KS 6 PACK
3446/2875
Pag. 104



DYON MIXED EXPRESS KS
3447/2877
Pag. 105



DYON MIXED EXPRESS KS 6 PACK
3441/3442
Pag. 105



PHOTON EXPRESS KS
3448/2879
Pag. 106



PHOTON EXPRESS KS 6 PACK
2881/2881
Pag. 106



PHOTON MIXED EXPRESS KS
3450/2887
Pag. 107



PHOTON MIXED EXPRESS KS 6 PACK
3451/2889
Pag. 107



PHOTON WIRE EXPRESS KS DYNEEMA®
3452/2883
Pag. 107



PHOTON WIRE EXPRESS KS DYNEEMA® 6 PACK
3453/2885
Pag. 107



LOCKER DRAW KS
3436
Pag. 108



NANO 22 EXPRESS KS
3435/2890
Pag. 109

Carabiners & Quickdraws



ORBIT EXPRESS KS
3454/3455/2894U/3363U
Pag. 110



ORBIT EXPRESS KS 6 PACK
3458/3437/3459/3438
Pag. 110



ORBIT MIXED EXPRESS KS
3456/2900U
Pag. 111



ORBIT MIXED EXPRESS KS 6 PACK
3461/3439
Pag. 111



ORBIT WIRE EXPRESS KS
3457/2897U
Pag. 111



ORBIT WIRE EXPRESS KS 6 PACK
3460/3440
Pag. 111



GYM SAFE EXPRESS
3462/3209
Pag. 112



GYM SAFE EXPRESS PLUS
3463/311918
Pag. 112



SLING STOP WIDE KS
343012/343018
Pag. 114



SLING STOP KS
290612 12 cm
Pag. 114



SLING STOP KS DYNEEMA®
297012 12 cm
Pag. 114

Poles



LASER
3466
Pag. 51



LASER W
3467
Pag. 51



LASER LOW SEGMENT
3468
Pag. 60



LASER W LOW SEGMENT
3469
Pag. 60

NEWS 2024

Harnesses



VELOCITY
3475
Pag. 165



ESCAPE
3474
Pag. 166



AURORA
3476
Pag. 167

Anchoring devices and webbing



EXPRESS SLING 80 cm
3130080
Pag. 121



EXPRESS SLING 160 cm
3130160
Pag. 121

Bouldering



MINIDO
3390
Pag. 188



GAMMA
3402
Pag. 190



ENIGMA
3259
Pag. 123



GYRO1
3260
Pag. 123



GYRO3
2940
Pag. 124

Chalk Bags



OMEGA
3401
Pag. 180



KAPPA
3427
Pag. 180



GYRO4
3109
Pag. 124



SWIVEL
1393
Pag. 125

Helmets



DIAL KIT FOR
SPEED COMP / STORM / ARMOUR
3188
Pag. 200

Packs



SF HOLDER
3464
Pag. 229

ICE AXES



ICE AXES

Ice axes may be the category that best represents C.A.M.P.'s reputation for lightweight and innovation. There are certainly other categories that can tell the same story, but nowhere else will climbers find such an uncommon blend of the lightest products in the world, pioneering materials, advanced engineering, and innovative design.

Construction and Design

Manufacturing ice axes is at the core of our company's history with innovations like the first modular-headed ice axe forging the way for more than 130 years. The Varrone Valley that is capped by Premana, where C.A.M.P. is based, is world-renowned for forging and advanced metallurgy. This means our picks are still forged by master craftsmen with the knowledge and skill that only a lineage developed via the old-school system of apprenticeship can create. Assemblies and finishing are also completed by the same craftsman and the result is an end product unlike any other. Add to this C.A.M.P.'s commitment to innovation, lightweight and advanced materials and you have the most advanced range of ice axes ever conceived.

C.A.M.P. X-Team

The most innovative and complete range of technical ice axes. Four models cover every specialty with the popular X-Dream for ice climbing, dry tooling and mixed, the X-Dream Alpine for the most technical mountain missions, the beloved X-All Mountain with its perfectly balanced swing, and the X-Light for lightweight technical missions on big mountains. The X-Dream and X-All Mountain use the same head so the Ice and Mixte picks along with the hammer and adze accessories can be used on both the tools. The X-Light and X-All Mountain also use the same modular grip with three different configurations to adapt to specific terrain.

Corsa Race: the lightest certified ice axe in the world

Of course it is a challenge we would accept! At 185 grams and fully certified, the Corsa Race takes hyperlight functionality to the extreme. Designed specifically for competitive ski mountaineering, it uses the tried and true design of the Corsa and tweaks it with variable thickness in the shaft and milled holes in the grip to reduce weight. It leads the Corsa family for lightweight, but the rest of the Corsa range has also been updated and expanded to give every kind of mountaineer the right tool for the job. The Corsa remains the hyperlight choice for general mountaineering. The Corsa Nanotech is still the most innovative ice axe with Sandvik Nanoflex steel inserts on the tip and spike. The Corsa Alpine brings a full steel head into the hyperlight realm for more technical routes.



CATEGORY LEADERS





The most advanced materials

Sandvik Nanoflex® is a ground-breaking stainless steel alloy which perfectly combines mechanical resistance, hardness and toughness, allowing the material to have a strength-to-weight ratio higher than titanium, aluminum and other conventional alloys. The amazing features of this material are created through a special heat treatment which gives rise to nanoparticles in its crystalline matrix, thus creating a hard and highly resistant structure. Sandvik Nanoflex® has a noticeably high tensile strength and an extremely high resistance to breaking, all while maintaining its malleability and resilience (this means being able to absorb elastic deformation energy). Sandvik Nanoflex® has a tensile strength greater than that of traditional heat-treated chromoly steel and is 25% harder. This means the metal is less likely to break under stress (resistance) and it will wear down more slowly and stay sharp longer (hardness). These properties allow a significant reduction in the amount of steel used, thereby saving weight while increasing performance: not only is it super strong, but thinner metal penetrates ice with less effort and less fracturing.

Technical Ice

Ref.	Product name	Weight		Modular head	Pick material	Shaft material	Spike material	CE
		g	oz					EN 13089
2864C	X-DREAM	595	21.0	•	Chromoly Steel	2.5 mm 7075 Alu		Type 2
2865C	X-DREAM ALPINE	615	21.7	•	Chromoly Steel	2.5 mm 7075 Alu	6 mm 7075 Alu	Type 2
2990C	X-ALL MOUNTAIN - Hammer	571	20.2	•	Chromoly Steel	2.5 mm 7075 Alu	Chromoly steel	Type 2
2991C	X-ALL MOUNTAIN - Adze	575	20.3	•	Chromoly Steel	2.5 mm 7075 Alu	Chromoly steel	Type 2

Mountaineering

Ref.	Product name	Length	Weight		Modular head	Pick material	Shaft material	Spike material	Leash	CE
			cm	g						oz
2518C	X-LIGHT - Hammer	50	525	18.5	•	Chromoly Steel	2.5 mm 7075 Alu	Chromoly steel		Type 2
2519C	X-LIGHT - Adze	50	520	18.4	•	Chromoly Steel	2.5 mm 7075 Alu	Chromoly steel		Type 2
2291	ALPINA	50	500	17.6		Chromoly Steel	2.5 mm 7075 Alu	Chromoly steel	Alpina	Type 2
		57	540	19.1						
		65	585	20.7						
		73	610	21.5						
3120	NEVE	50	438	15.5		Chromoly Steel	2.5 mm 6082 Alu	Chromoly steel	Touring	Type 1
		57	475	16.8						
		65	515	18.2						
		73	560	19.8						
2975	CORSALPINE	45	240	8.5		Chromoly Steel	1.3 mm 7075 Alu		Corsa	Type 1
		55	265	9.4						
2973	CORSARACE	50	185	6.5		7075 Aluminum	1.3 mm 7075 Alu		Corsa	Type 1
		50	202	7.1						
2972	CORSALPINE	60	232	8.2		7075 Aluminum	1.3 mm 7075 Alu		Corsa	Type 1
		70	261	9.2						
		70	261	9.2						
2974	CORSANANOTECH	50	225	7.9		7075 Aluminum / Nanoflex®	1.3 mm 7075 Alu	Nanoflex®	Corsa	Type 1
		60	253	8.9						
		70	284	10.0						

Ice axes classification and marking according to EN 13089:2015

- **Class 1:** an ice axe primarily for snow and ice.

In the past this category was labeled class circled 'B'. Marking is not required on hardware in this class.

- **Class 2:** an ice axe for snow, ice, dry-tooling and more technical routes.

The ice axe shaft and interchangeable picks with this classification are marked with a circled letter 'T'.

ICE AXES

Technical Ice



X-DREAM
2864C



X-DREAM ALPINE
2865C



X-ALL MOUNTAIN - Hammer
2990C



X-ALL MOUNTAIN - Adze
2991C

Mountaineering



X-LIGHT - Hammer
2518C



X-LIGHT - Adze
2519C



ALPINA
2291



NEVE
3120



CORSALPINE
2975



CORSARACE
2973



CORSALPINE
2972



CORSALPINE
2974



X-DREAM

2864C

1ST CLASS

CC4U

PAT. PEND.

ICE CLIMBING, MIXED CLIMBING

- Hyperlight, perfectly balanced, fully featured tool for technical dry, mixed and ice climbing
- Multi-part head design with four pick options -- the Mixte and Ice picks can be combined with hammer or adze for amazing versatility
- Comes standard with the Mixte pick; Ice, Race and Total Dry picks can be purchased separately
- Ergonomic handle with innovative adjustment system to change between Dry and Ice angles
- The handle is constructed from extreme cold resistant polymer laid over the hot-forged aluminum alloy spine
- Micro-adjustable trigger finger ledges and X-Rest insert adjust the overall height and size of the handle
- X-Trigger pommel attaches to the shaft for a third position
- X-Grip 2 included

The X-Dream combines two tools in one – a fully optimized tool for technical ice and an aggressive dry tooling machine. This amazing ice axe not only features four different T rated picks for various terrain, but it also incorporates an innovative adjustment system in the handle to fine tune the swing and pull even further. Use the allen bolt above the grip to switch between Dry and Ice positions. In the Dry position, the handle kicks upward for a more down and out pull. The Ice position drops the handle for a more natural swing on ice. Climbers can further refine the X-Dream with micro-adjustable trigger finger ledges (choose from two inserts – the X-Finger Small or the X-Finger Large – that can be flipped over to adjust the position) and the X-Rest insert which adjusts the overall height of the handle. All four picks feature a refined beak and tooth configuration. They are designed to provide solid sticks with minimal effort making them the perfect choice for brittle ice and technical mixed terrain. The X-Dream comes standard with the Mixte pick. The Ice pick brings the tip 6 mm closer to the handle, but maintains the same angle as the Mixte pick. The Mixte and Ice picks can be used alone or with the hammer or adze. The Race pick features a sharp beak for grappling with rock. The Total Dry pick is designed for maximum performance on overhanging dry tooling routes and in competitions.



X-DREAM GRIP

3065C 170 g

PAT. PEND.

The original X-Dream handle with no spike (standard on the original X-Dream) for the best clearance on technical ice and mixed terrain. Sold separately so climbers can modify their X-Dream Alpine tools for dry-tooling and technical ice.

Ref.	Product name	Weight		Modular head	Pick material	Shaft material	Spike material	CE
		g	oz					
2864C	X-DREAM	595	21.0	•	Chromoly Steel	2.5 mm 7075 Alu		EN 13089 Type 2



X-DREAM ALPINE

2865C

1ST CLASS

CC4U

PAT. PEND.

ICE CLIMBING, ALPINISM

- Hyperlight, perfectly balanced, fully featured tool for alpine climbing and long technical ice routes
- New multi-part head design with four pick options -- the Mixte and Ice picks can be combined with hammer or adze for amazing versatility
- Comes standard with the Ice pick and hammer
- Ergonomic handle with integrated spike and innovative adjustment system to change between Dry and Ice angles
- The handle is constructed from extreme cold resistant polymer laid over the hot-forged aluminum alloy spine
- X-Rest insert for adjusting the height of the handle
- X-Grip 2 included

The X-Dream Alpine is the alpine climbing version of the award-winning X-Dream ice tool. It features the same innovative design and geometry that have made the X-Dream so popular, with the addition of the alpine handle that incorporates a spike designed for use in the cane position and a hammer to provide extra head weight and for pounding pitons and clearing ice. A variety of inserts allow the main grip to be modified both in volume and shape to help climbers craft the perfect grip. The result is a fully optimized tool for technical ice, mixed climbing, and adventurous alpine terrain. The most innovative feature on the X-Dream Alpine remains with the angle-adjustable handle that allows climbers to switch between Dry and Ice positions. Use the Allen bolt above the grip to switch between the two positions. In the Dry position, the handle kicks upward for a more down and out pull. The Ice position drops the handle for a more natural swing on ice. All four picks feature a refined beak and tooth configuration. They are designed to provide solid sticks with minimal effort making them the perfect choice for brittle ice and technical mixed terrain. The new multi-part head design allows the same pick to be used alone or with the hammer or adze. The X-Dream Alpine comes standard with the Ice pick and hammer. The Mixte pick shifts the tip 6 mm higher, but maintains the same angle as the Ice pick. The Ice and Mixte picks can be used alone or with the hammer or adze. The Race pick features a sharp beak for grappling with rock. The optional Total Dry pick is designed for maximum performance on overhanging dry tooling routes and in competitions.



X-DREAM ALPINE GRIP

3066C 176 g

PAT. PEND.

The X-Dream Alpine Handle has an integrated spike to optimize the tool for alpine climbing and use in cane position. Sold separately so climbers with the original X-Dream tools can swap handles according to specific objectives.

Ref.	Product name	Weight		Modular head	Pick material	Shaft material	Spike material	CE EN 13089
		g	oz					
2865C	X-DREAM ALPINE	615	21.7	•	Chromoly Steel	2.5 mm 7075 Alu	6 mm 7075 Alu	Type 2



X-ALL MOUNTAIN

2990C Hammer

2991C Adze

CC4U

ICE CLIMBING, ALPINISM

- Lightweight, technical ice tool designed for big mountain terrain
- Multi-part head design with two pick options that can be combined with hammer or adze
- 3 part handle can be optimized for different conditions and hand size
- Steel spike has a hole large enough to clip a carabiner for use with lanyards

The X-All Mountain is a technical ice tool designed to handle everything the big mountains throw at it. The balance and geometry are optimized to climb vertical ice with unparalleled proficiency and the rest of the features allow the tool to adapt to the varied terrain typical of advanced alpinism. The multi-part head can be configured with a hammer or adze. The three-part handle can be configured to fit hand size and the terrain being climbed. The steel spike is big enough to function as a cane and has a hole that is large enough to clip a carabiner for use with lanyards.



X-LIGHT

2518C Hammer

2519C Adze

CC4U

ALPINISM

- A lightweight, versatile tool for the technical alpinist
- Hot-forged aluminum alloy head allows for 2 configurations: adze and hammer
- T-rated chromoly steel pick and T-rated 7075-T6 aluminum alloy shaft (CE-UIAA type 2)
- 3 part handle can be optimized for different conditions
- Interchangeable steel spike has a hole large enough to clip a carabiner for use with lanyards

The X-Light takes the same quality forged components and profiled geometries as the X-Dream and X-All Mountain tools, but simplifies the shaft to make it the most suitable axe for low-angle terrain typical of light and fast technical ascents. Two different head configurations (adze and hammer) allow the tool to be perfectly optimized for the objective. The single-curve shaft is optimized with the angle of the pick for solid performance on alpine ice and for use as a cane. Carabiner holes at the head and spike accommodate traditional leashes or lanyards. The 3 part handle can be assembled in the precise way that fits the terrain being climbed with an upper pommel that can be repositioned without tools. It also increases mechanical resistance to the specific stresses on each part of the handle. The hammer and adze components have been shaped for a comfortable grip and the pick does not have teeth near the shaft to further increase comfort and help limit wear and tear on gloves.

Ref.	Product name	Length	Weight		Modular head	Pick material	Shaft material	Spike material	CE EN 13089
		cm	g	oz					
2990C	X-ALL MOUNTAIN - Hammer		571	20.2	•	Chromoly Steel	2.5 mm 7075 Alu	Chromoly steel	Type 2
2991C	X-ALL MOUNTAIN - Adze		575	20.3	•	Chromoly Steel	2.5 mm 7075 Alu	Chromoly steel	Type 2
2518C	X-LIGHT - Hammer	50	525	18.5	•	Chromoly Steel	2.5 mm 7075 Alu	Chromoly steel	Type 2
2519C	X-LIGHT - Adze	50	520	18.4	•	Chromoly Steel	2.5 mm 7075 Alu	Chromoly steel	Type 2



ALPINA

2291

CC4U

MOUNTAINEERING, ALPINISM

- Rugged T-rated pick and shaft (CE-UIAA type 2)
- Forged chromoly steel head
- Ergonomic head design for a comfortable grip
- Asymmetric steel spike plunges smoothly
- Equipped with the technical Alpina leash (1304)
- Carabiner holes at the head and spike for easy clipping
- Striking colors coordinate with the technical C12 crampons
- CC4U wear indicator warns when the pick is dull beyond the safe limit

With its super-strong T-rated construction on the head and shaft, the Alpina is the right choice for intensive use on rugged alpine terrain. The unique forged chromoly steel head delivers superior strength and durability. A refined pick provides excellent performance both when swinging into ice and during self arrest. The curve and arc of the adze have been optimized for maximum cutting performance, a feature greatly appreciated when chopping a platform. In addition, the sculpted head with the thermoplastic cap creates a comfortable hand grip when using the axe as a cane.



Video

NEVE

3120

BEST SELLER

MOUNTAINEERING, ALPINISM

- Updated design optimizes performance and comfort
- Forged chromoly steel pick and adze with an ergonomic design for good comfort and the best grip
- Ergonomic adze is shaped and sized for optimal chopping performance
- Carabiner holes on the head and spike for leashes and tethers
- Steel spike for clean plunging
- Equipped with Touring Leash (1305)

The Neve is a classic, reliable ice axe for mountaineering and glacier travel. The forged chromoly steel head has an ergonomic design for a secure grip and good comfort. The pick is engineered for solid anchoring in hard snow and a high level of control during self-arrest. The adze has an ergonomic profile and is engineered for chopping snow and ice. The steel spike plunges cleanly and the holes in the spike and head can be used with carabiners for leashes and tethers. Comes equipped with the Touring Leash (1305).

Ref.	Product name	Length		Weight		Modular head	Pick material	Shaft material	Spike material	Leash	CE EN 13089
		cm	g	oz							
2291	ALPINA	50	500	17.6			Chromoly Steel	2.5 mm 7075 Alu	Chromoly steel	Alpina	Type 2
		57	540	19.1							
		65	585	20.7							
		73	610	21.5							
3120	NEVE	50	438	15.5			Chromoly Steel	2.5 mm 6082 Alu	Chromoly steel	Touring	Type 1
		57	475	16.8							
		65	515	18.2							
		73	560	19.8							

CORSA ALPINE

2975

CC4U

MOUNTAINEERING, ALPINISM, SKI MOUNTAINEERING

- A lightweight axe with a steel head for technical terrain
- Designed for glacier travel, alpinism and ski mountaineering
- Pick is tapered to 3 mm for better penetration on hard snow and ice
- Nylon spike plug keeps snow out of the shaft
- Small head slot for seamless integration with the Corsa leash (sold separately)
- Machined grip for good handling

The Corsa Alpine joins the hyperlight Corsa aluminum shaft with an all-steel head for a high level of performance on technical terrain. The 45 cm length is particularly well suited for ski mountaineering and alpine adventures that require the performance of steel along with the benefits of lightweight. The single-curve shaft provides extra clearance without interfering with walking or plunging performance. A lightweight nylon spike plug keeps ice out of the shaft. The grip is machined for good handling and a small slot in the head allows for seamless integration with the Corsa leash (sold separately).



Video



CORSA RACE

2973

LIGHT&FAST

SKI COMP



COMPETITIVE SKI MOUNTAINEERING

- The lightest certified ice axe in the world
- Designed specifically for competitive ski mountaineering racers
- 50 cm length meets the minimum standard for the ISMF
- Reductions in shaft material and removal of the shaft plug cut weight to the absolute minimum
- Small head slot for seamless integration with the Corsa leash (sold separately)
- Machined holes in the grip reduce weight and improve handling

The Corsa Race is purpose built for competitive ski mountaineering racers who demand the lightest possible equipment. Weight reductions were achieved by reducing shaft material, machining holes in the grip which also improves handling, and removing the shaft plug. The result is a hyperlight ice axe that is still rated in accordance with the EN 13089 Type 1 standard. A small slot in the head allows for seamless integration with the Corsa leash (sold separately). Not suitable for use on vertical ice, mixed terrain or for intense step chipping.



Video



Ref.	Product name	Length		Weight		Modular head	Pick material	Shaft material	Spike material	Leash	CE EN 13089
		cm	oz	g	oz						
2975	CORSA ALPINE	45	8.5	240			Chromoly Steel	1.3 mm 7075 Alu		Corsa	Type 1
		55		265	9.4						
		65		290	10.2						
2973	CORSA RACE	50	6.5	185			7075 Aluminum	1.3 mm 7075 Alu		Corsa	Type 1



CORSA

2972

MOUNTAINEERING, SKI MOUNTAINEERING, HIGH ALTITUDE

- Hyperlight ice axe for glacier travel and ski mountaineering
- Nylon spike plug keeps snow out of the shaft
- Small head slot for seamless integration with the Corsa leash (sold separately)
- Machined grip for good handling

The Corsa is a hyperlight ice axe designed for glacier travel and ski mountaineering. The aluminum alloy construction is lightweight, but still rated in accordance with EN 13089 Type 1 for use as a snow anchor and self-arrest. A lightweight nylon spike plug keeps snow out of the shaft. The grip is machined for good handling and a small slot in the head allows for seamless integration with the Corsa leash (sold separately). Not suitable for use on vertical ice, mixed terrain or for intense step chipping.



Video



CORSA NANOTECH

2974

1ST CLASS

MOUNTAINEERING, SKI MOUNTAINEERING, HIGH ALTITUDE

- A technical version of the Corsa with a single-curve shaft and Sandvik Nanoflex® steel reinforced tip and spike for a solid grip on hard snow and ice
- Designed for glacier travel and ski mountaineering
- Nylon spike plug keeps snow out of the shaft
- Small head slot for seamless integration with the Corsa leash (sold separately)
- Machined grip for good handling

The Corsa Nanotech is the most advanced mountaineering ice axe on the market. It merges the hyperlight properties of aluminum construction with a Sandvik Nanoflex® steel reinforced tip and spike for a solid grip on hard snow and ice. The steel components dramatically increase the performance of these critical points without significantly increasing the weight of the axe. The single-curve shaft provides extra clearance without interfering with walking or plunging performance. A lightweight nylon spike plug keeps snow out of the shaft. The grip is machined for good handling and a small slot in the head allows for seamless integration with the Corsa leash (sold separately). Not suitable for use on vertical ice, mixed terrain or for intense step chipping.



Video



Sandvik Nanoflex® is an innovative steel alloy that is stronger and 25% harder than normal steel which allows for a significant reduction in the amount of metal used, thereby decreasing weight while maintaining strength.

Ref.	Product name	Length		Weight		Modular head	Pick material	Shaft material	Spike material	Leash	CE
		cm	g	oz	EN 13089						
2972	CORSA	50	202	7.1		7075 Aluminum	1.3 mm 7075 Alu		Corsa	Type 1	
		60	232	8.2							
		70	261	9.2							
2974	CORSA NANOTECH	50	225	7.9		7075 Aluminum / Nanoflex®	1.3 mm 7075 Alu	Nanoflex®	Corsa	Type 1	
		60	253	8.9							
		70	284	10.0							

X-GYRO LEASH**012601C** Size 1 - 85/129 cm - 133 g**012602C** Size 2 - 92/147 cm - 142 g

DESIGN PAT. PEND.

ALPINISM, ICE CLIMBING

- Features the innovative Gyro swivel that allows three connection points to rotate independently of each other so twists and tangles are virtually eliminated
- Elastic rewind lanyards automatically contract to their short length to stay out of the way while climbing
- Axes connect with light and super-compact clips (included) or small loops of cord for girth-hitching
- Available in two lengths to fit all climbers

The innovative X-Gyro lanyard system uses a swivel design that allows each attachment point (harness + left axe + right axe) to rotate completely independently from the others. This means no more tangles and no more twisting. The rewind elastic webbing cords stretch easily for swinging and contract back to their original length to keep them out of the way. Attachment to the axe can be done in two ways. For maximum security, use the loop of cord to girth-hitch the spike or handle of the axe. Or make it easy to attach and detach the axes with the light and super-compact clips provided. Available in two lengths to fit all climbers.

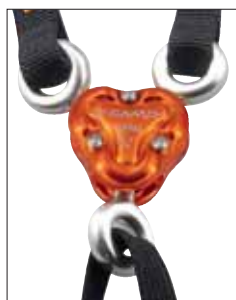



HUB

0910 36 g

ALPINISM, ICE CLIMBING

- Fits on most climbing harness waist belts
- Convenient racking for ice screws and tools

A wire gate racking carabiner with a wide gate opening and super smooth gate action designed to carry up to six ice screws. The Hub is also superior to a traditional holster for carrying ice tools that have modern shapes or leashes—just clip the head.



SCORPIO

3023C 32 g

ALPINISM, ICE CLIMBING

- Plastic cap slides down to prevent unwanted snagging
- Fits inside ice screws for clearing plugs

Lightweight hook for threading V-thread anchors and removing ice from the tube of an ice screw. 24 cm.

X-LIGHT PICK

2287C 76 g



X-LIGHT HAMMER

2288C 53 g



X-LIGHT ADZE

2289C 47 g



X-DREAM RACE PICK

3052C 113 g

- T-rated pick - Extreme beak is optimized for overhanging dry tooling

T-rated pick optimized for the X-Dream ice tools. The extreme beak and tooth configuration are designed for the overhanging dry tooling routes.



X-DREAM / X-ALL MOUNTAIN MIXTE PICK

2803C 115 g

- T-rated pick - Optimized for technical mixed climbing and steep ice

T-rated pick designed to deliver the optimal balance of performance on both technical mixed and ice terrain. Multi-part design allows the same pick to be used alone or with the hammer (ref. 2688C) or the adze (ref. 2689C).



X-DREAM / X-ALL MOUNTAIN ICE PICK

2804C 102 g

- T-rated pick - Optimized for technical ice

T-rated pick optimized for the best performance on technical ice. New multi-part design allows the same pick to be used alone or with the hammer (ref. 2688C) or the adze (ref. 2689C).



X-DREAM TOTAL DRY PICK

2523C 110 g

- T-rated pick for overhanging dry tooling routes and competitions

A new pick designed for maximum performance on overhanging dry tooling routes and in competitions. The Total Dry Pick has even more aggressive geometry than the Race Pick and a constant thickness of 4 mm with a special heat treatment to increase durability and rigidity.



X-ALL MOUNTAIN / X-LIGHT GRIP

2522C 90 g

A 3 part version of the X-All Mountain handle that is compatible for use on older versions of the X-All Mountain and X-Light tools. The 3 part system allows it to be assembled in the precise way that fits the terrain being climbed and allows the climber to fine-tune the position of the upper pommel. It also increases mechanical resistance to the specific stresses on each part of the handle. Spike included.



X-DREAM / X-ALL MOUNTAIN HAMMER

2688C 42 g

Optimized hammer designed for the X-Dream, X-Dream Alpine and X-All Mountain ice tools. Compatible with the X-Dream/X-All Mountain Ice Pick (ref.2804C) and X-Dream/X-All Mountain Mixte Pick (ref.2803C).



X-DREAM / X-ALL MOUNTAIN ADZE

2689C 46 g

Profiled adze designed for the X-Dream, X-Dream Alpine and X-All Mountain ice tools. Compatible with the X-Dream/X-All Mountain Ice Pick (ref.2804C) and X-Dream/X-All Mountain Mixte Pick (ref.2803C).



X-DREAM / X-ALL MOUNTAIN HEAD WEIGHTS

2524C 62 g

Head weights to optimize the X-Dream, X-Dream Alpine and X-All Mountain for thin, brittle ice where one swing penetration is a necessity. The weights can be used with all of the picks. The addition of the central piece increases the weight from 43 g to 62 g. Sold individually. One head weight kit includes the three parts and installation hardware for one axe.



X-GRIP 2

3059C 3.5 g

Friction tape for use on the shaft of leashless tools. It is designed specifically for the shaft of the X-Dream.



X-TRIGGER FAST

2292C 15 g

A low-profile pinky pommel that attaches to the shaft of X-Dream, X-Dream Alpine, X-All Mountain, X-Light to offer an extra swapping or resting point. Sold individually.



3055C

3056C

X-FINGER

3055C Small - 2 g

3056C Large - 3 g

Trigger finger inserts for customizing the X-Dream Ice Tools. The X-Finger inserts are flippable for millimetric adjustment. Sold individually.



X-REST

3057C 6 g

Inserts for customizing the X-Dream Ice Tools. The X-Rest handle height insert raises the height of the handle interior by 5 mm. Sold individually.



CORSА LEASH

2976 25 g

A lightweight leash designed to fit any ice axe. Integrates seamlessly with the Corsa range. The wrist loop is easy to open, quickly adjusts in size, and remains securely fixed in the desired position.



ALPINA LEASH

1304 35 g

A technical leash designed to fit nearly any ice axe. The wrist loop quickly adjusts in size, a useful feature on climbs where you may need gloves in the morning and bare hands in the afternoon. A small loop holds your hand close to the shaft for quick retrieval but slides up when using the tool as a cane.



TOURING LEASH

1305 29 g

A simple sliding leash designed to fit the shaft dimensions on all C.A.M.P. mountaineering ice axes, as well as many other brands (the shaft opening is 25 x 35 mm). A heavy rubber stopper secures the slider at the bottom.



HEAD PROTECTOR

0389 31 g

Classic rubber guard that prevents the pick and adze from tearing up gear.



SPIKE/PICK PROTECTOR

0391 4 g

A rubber protector that fits the spike of traditional ice axes. Also designed to be used on picks.

CRAMPONS



Luka Lindič in full action during the first ascent of "Heart of Stone" (1000 m, M7) on the west face of Mount Huntington (3731 m), Alaska © Ines Papert

CRAMPONS

While the ice axe has become the iconic symbol of mountaineering, it is crampons that actually propel and protect us with each step. This is why C.A.M.P. continues to push the boundaries of innovation with this key piece of gear.

Construction and Design

The history of crampon innovation at C.A.M.P. is as old as the company itself. It follows the same heritage of master metallurgy for which the Varrone Valley, where C.A.M.P. is based, is world-renowned. Like our axes, crampons are constructed from start to finish by master craftsmen with the knowledge and skill that only a history steeped in tradition and developed via the old-school system of apprenticeship can create. Include the contributions of engineers who have been navigating the Alps on foot since the time they could walk, and the result is a complex blend of innovation marked by intricate shapes, advanced materials, and top-end manufacturing. We apply this approach to our entire range of crampons, from the top end Blade Runner and Alpinist Tech to the compact Ascent and technical Skimo series crampons.



The Revolution is here

The Blade Runner represents the best application of the principles of construction and design highlighted above. It is the most versatile crampon on the market with interchangeable binding systems and front points specifically designed for technical ice or alpinism. The heel slide integrates the linking bar with the heel piece for exceptional torsional rigidity; something that has been lost in the current era of crampon designs. We have also incorporated a variation of this design into the Alpinist Pro and Alpinist Tech crampons. They have been built as the ultimate tools for alpine and ice climbers with an asymmetric design that follows the contours of modern boots, perfect placement of primary and secondary points, a micro-adjustable linking bar for dialing in a precise fit, and dynamic anti-balling plates that equip all of our crampons.



Go Light

Because crampons are such a critical part of mountaineering safety, many traditional climbers balk at the idea of using aluminum, which they view as inferior to steel. The reality is that by using today's advanced alloys along with compound shapes, many of the immediate concerns about aluminum alloy can be addressed through engineering. Other issues are addressed by understanding the limitations of the materials. We draw the distinction between steel and aluminum simply: aluminum is for stepping and steel can be used for kicking. Most classic mountaineering routes do not require true front-pointing. For these routes, the lightweight benefits of aluminum alloy far outweigh the limitations. With each and every step, climbers using lightweight aluminum crampons will save energy making them more capable and aware. The trick becomes matching the right aluminum crampons to your specific objective. This is why the range of lightweight crampons from C.A.M.P. is far larger than any other brand.



Skimo

Working in conjunction with the world's elite ski mountaineering athletes, C.A.M.P. has developed the next level of crampons specifically for ski mountaineering. The range has been uniquely designed around the growing number of A/T boot models. We are elated that ski mountaineering continues to grow in popularity and we are glad that skiers have ever more options for boots. But we have also seen a negative impact on boot/crampon compatibility as crampons have not kept pace with the developments in boots. So we set out to find a solution. By reshaping the frames and developing a new interface for the toe called T-Stop, the range of Skimo crampons attach faster and fit more securely to A/T ski boots than any other crampons on the market. Of course, keeping with our light & fast mentality, they are also some of the lightest crampons in the world. The range includes the Skimo Total Race (winner of the 2018 ISPO Product Design Award and Gold Winner at the 2018 OutDoor Industry Awards) and the Skimo Race for the hyperlight crowd, the Skimo Tour and Skimo Tour Nanotech (with Sandvik Nanoflex® steel front points) for backcountry crushers, and the Skimo Pure Nanotech constructed completely from Sandvik Nanoflex® for the most demanding enthusiasts and competitions that require steel crampons.

CATEGORY LEADERS



1ST CLASS
BLADE RUNNER
298001C/298002C



LIGHT&FAST **1ST CLASS**
SKIMO PURE NANOTECH
2981



LIGHT&FAST
SKIMO RACE
2584



BEST SELLER
STALKER UNIVERSAL
292003



The most advanced materials

Sandvik Nanoflex® is a ground-breaking stainless steel alloy which perfectly combines mechanical resistance, hardness and toughness, allowing the material to have a strength-to-weight ratio higher than titanium, aluminum and other conventional alloys. The amazing features of this material are created through a special heat treatment which gives rise to nanoparticles in its crystalline matrix, thus creating a hard and highly resistant structure. Sandvik Nanoflex® has a noticeably high tensile strength and an extremely high resistance to breaking, all while maintaining its malleability and resilience (this means being able to absorb elastic deformation energy). Sandvik Nanoflex® has a tensile strength greater than that of traditional heat-treated chromoly steel and is 25% harder. This means the metal is less likely to break under stress (resistance) and it will wear down more slowly and stay sharp longer (hardness). These properties allow a significant reduction in the amount of steel used, thereby saving weight while increasing performance: not only is it super strong, but thinner metal penetrates ice with less effort and less fracturing.

Binding Systems

C.A.M.P. crampons use three binding systems, each optimized to fit specific styles of boots and specific styles of climbing.

- Automatic Bindings are designed to fit boots with a fully rigid platform that keeps them from flexing too much underfoot, and with heel and toe lugs specifically designed for crampon compatibility. Automatic bindings will provide the most secure fit when used in conjunction with rigid boots and they are the lightest option. They are also the only recommended binding for ski boots as the other binding systems will not offer the same secure fit.
- Semi-Automatic Bindings have a universal toe harness combined with an automatic heel bail. This is a popular system for technical alpinism because it realizes some of the benefits of automatic bindings, but will be compatible with boots that eliminate the bulky toe lug so the boot can climb rock with more precision.
- Universal Bindings are designed to fit on any boot or shoe thanks to thermo-plastic heel and toe baskets. Universal Bindings are an excellent choice for mountaineering, but should not be used for technical alpine climbing or ski mountaineering where a more precise fit is recommended.

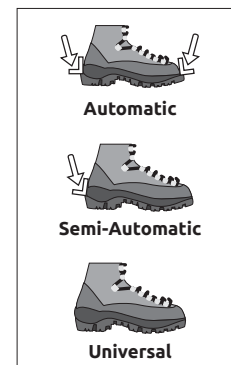

Technical Ice

Ref.	Product name	Weight		Weight no antibott g	Size (*) European	Boot type			Points	Frame material	Antibott	CE EN 893
		g	oz			Automatic	Semi-Automatic	Universal				
298001C	BLADE RUNNER Size 1	940	33.2	828	37-46	•	•		13/14	Chromoly Steel / Nanoflex®	Included	•
298002C	BLADE RUNNER Size 2	950	33.5	838	40-49	•	•		13/14	Chromoly Steel / Nanoflex®	Included	•
2860C	DRY	334	11.8						8	NiCrMo Steel		•
2861C	T-DRY	206	7.3						3	NiCrMo Steel		•
2680C	ALPINIST TECH	810	28.6	689	36-48	•	• + Art.2453C + Art.2450C		11	NiCrMo Steel	Included	•

Mountaineering

Ref.	Product name	Weight		Weight no antibott g	Size (*) European	Boot type			Points	Frame material	Antibott	CE EN 893
		g	oz			Automatic	Semi-Automatic	Universal				
2449C	ALPINIST PRO - AUTO / SEMI-AUTO	960	33.9	842	36-48	•	•		12	NiCrMo Steel	Included	•
2979	ASCENT - UNIVERSAL	776	27.4	708	34-48	• + Art.2452 + Art.2588	• + Art.2588	•	10	NiCrMo Steel	Included	•
2978	ASCENT - AUTO / SEMI-AUTO	728	25.7	660	34-48	•	•	• + Art.2988	10	NiCrMo Steel	Included	•
292003	STALKER - UNIVERSAL	885	31.2	800	36-48	•	•	•	12	NiCrMo Steel	Included	•
292004	STALKER - SEMI-AUTOMATIC	890	31.4	795	36-48	•	•		12	NiCrMo Steel	Included	•
254402	XLC NANOTECH - SEMI-AUTOMATIC	650	22.9	571	36-48	•	•		12	7075 Aluminum / Nanoflex®	Included	•
254403	XLC NANOTECH - AUTOMATIC	560	19.8	481	36-47	•			12	7075 Aluminum / Nanoflex®	Included	•
254201	XLC 490 - UNIVERSAL	585	20.7	506	36-48	•	•	•	12	7075 Aluminum	Included	•
254202	XLC 470 - SEMI-AUTOMATIC	575	20.3	496	36-48	•	•		12	7075 Aluminum	Included	•
254203	XLC 390 - AUTOMATIC	490	17.3	411	36-47	•			12	7075 Aluminum	Included	•

Ski Mountaineering

Ref.	Product name	Weight		Weight no antibott g	Size (*) European	Sole length		Boot type		Points	Frame material	Antibott	CE EN 893
		g	oz			mm	mm	Automatic	Semi-Automatic				
2584	SKIMO RACE	425	15.0	350	36-46	210-260	260-330	•	• + Art.2589 + Art.2588	10	7075 Aluminum	Included	•
2586	SKIMO NANOTECH	470	16.6	395	36-46	210-260	260-330	•	• + Art.2589	10	7075 Aluminum / Nanoflex®	Included	•
2981	SKIMO PURE NANOTECH	592	20.9	524	36-46	210-260	260-330	•	• + Art.2589	10	Nanoflex®	Included	•

The weight of crampons sold with mounted Antibott (see product picture) is inclusive of the Antibott weight
 (*) Sizing varies depending on different boots, brands and models

CRAMPONS

Technical Ice



BLADE RUNNER
298001C/298002C



ALPINIST TECH
2680C

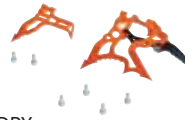

DRY
2860C



T-DRY
2861C

Mountaineering



ALPINIST PRO
AUTO / SEMI-AUTO
2449C



ASCENT
UNIVERSAL
2979



ASCENT
AUTO / SEMI-AUTO
2978



STALKER
UNIVERSAL
292003



STALKER
SEMI-AUTOMATIC
292004



XLC NANOTECH
SEMI-AUTOMATIC
254402



XLC NANOTECH
AUTOMATIC
254403



XLC 490
UNIVERSAL
254201



XLC 470
SEMI-AUTOMATIC
254202



XLC 390
AUTOMATIC
254203

Ski Mountaineering



SKIMO RACE
2584



SKIMO NANOTECH
2586



SKIMO PURE NANOTECH
2981



BLADE RUNNER

298001C Size 1

298002C Size 2

1ST CLASS

CC4U

PAT. PEND.

ICE CLIMBING, MIXED CLIMBING

- The most technical ice crampon on the market
- Innovative design integrates the benefits of vertical and horizontal frame crampons
- The heel slide is constructed from innovative Sandvik Nanoflex® steel for the optimal blend of strength, flex and lightweight
- Interchangeable front points are easy to switch from dual to mono, centered or offset
- Optional snow points optimize the crampons for alpine terrain
- Asymmetric design follows the contours of modern boots to ensure a precise fit
- Automatic front bail enhances the fit on modern boots and semi-automatic toe bails allow for use on boots without rigid toe lugs
- Anti-balling plates are more dynamic to help prevent snow build up
- Micro-adjustable linking bar for fine tuning the length
- Heel bail with 3 height settings
- Available in two sizes for optimal boot fit
- Comes pre-equipped with mono-points and automatic toe bails
- Two extra front points (ref. 0145C) and semi-auto toe bails (ref. 2453C) are included in the box
- Adjustable fold-over carrying case with lashing straps included

The Blade Runner represents the absolute top of the line in technical ice crampons. A wealth of innovative features combine to create a crampon that conforms to the ergonomics of modern boots, increases rigidity and performance, and adapts to conditions with a variety of front points and toe bail configurations. The heel slide integrates the linking bar with the heel piece for better torsional rigidity. This allows the Blade Runner to offer the best of both worlds by combining the power and stability of vertical frame crampons with the precision and ease of adjustment of horizontal frame designs. The entire heel slide is constructed from innovative Sandvik Nanoflex® steel: an amazingly strong and tough stainless steel that allows for a reduction in the thickness of the frame from 2.75 mm to 1.8 mm, thereby reducing weight while simultaneously increasing strength and providing the right amount of longitudinal flexibility for a precise fit on modern boots with more extreme rocker. The front platform is constructed from traditional chromoly steel alloy to absorb impact energy and maintain solid rigidity under foot. The elimination of connection joints leaves little room for play and reduces much of the flex that can make crampons feel insecure on technical terrain. The sophisticated geometry of the front points interact with the secondary points on the main frame for easy penetration and superior hold even in the most fickle conditions. Switching the front points between dual and mono, centered or offset, is made easy with the hook and notch system. The optional snow points convert the Blade Runner into all mountain machines with their beveled design and precise shape and spacing that maximizes purchase in hard snow. Delivered standard with both automatic and semi-auto toe bails. New anti-balling plates are more dynamic to help prevent snow build-up underfoot.

 Sandvik Nanoflex® is an innovative steel alloy that is stronger and 25% harder than normal steel which allows for a significant reduction in the amount of metal used, thereby decreasing weight while maintaining strength.

Ref.	Product name	Weight		Weight no antibott g	Size (*) European	Boot type		Points	Frame material	Antibott	CE EN 893
		g	oz			Automatic	Semi-Automatic				
298001C	BLADE RUNNER Size 1	940	33.2	828	37-46	•	•	13/14	Chromoly Steel / Nanoflex®	Included	•
298002C	BLADE RUNNER Size 2	950	33.5	838	40-49	•	•	13/14	Chromoly Steel / Nanoflex®	Included	•

(*) Sizing varies depending on different boots, brands and models



DRY 2860C

CC4U

ICE CLIMBING, MIXED CLIMBING

- Bolt-on crampons based on the proven geometry of the Blade Runner
- Five-point front part attaches to the boot with 4 bolts and allows for ± 3 degrees of rotation
- Mono point can be set in two positions (centered and offset)
- Three-point heel part attaches to the boot with 2 bolts and allows for 10 mm of adjustment from front to back

The Dry is a bolt-on crampon designed for top level ice climbing and mixed climbing competitions. Based on the proven geometry of the Blade Runner, the mono point ensures single kick sticks and interacts with the secondary points for a high level of stability and control. The 5-point front part attaches to the boot with 4 bolts and allows for ± 3 degrees of rotation. The mono point can be set in two positions (centered and offset). The 3-point heel part attaches to the boot with 2 bolts and allows for 10 mm of adjustment from front to back. EN 893 certified with Kayland Ice Dragon, Kayland Dry Dragon and La Sportiva Mega Ice Evo boots.



T-DRY 2861C

CC4U

MIXED CLIMBING

- Bolt-on crampons stripped down for use exclusively on rock
- Three-point front part attaches to the boot with 4 bolts and allows for ± 3 degrees of rotation
- Mono point can be set in two positions (centered and offset)

The T-Dry is a bolt-on crampon designed exclusively for use on rock. The 3-point front part attaches to the boot with 4 bolts and allows for ± 3 degrees of rotation. The mono point can be set in two positions (centered and offset). Tested with Kayland Ice Dragon, Kayland Dry Dragon and La Sportiva Mega Ice Evo boots.

Ref.	Product name	Weight		Points	Frame material	CE EN 893
		g	oz			
2860C	DRY	334	11.8	8	NiCrMo Steel	•
2861C	T-DRY	206	7.3	3	NiCrMo Steel	•



ALPINIST TECH

2680C

ICE CLIMBING, ALPINISM, MIXED CLIMBING

- Aggressive mono-point functionality with a secondary front point for greater support and stability
- Our lightest technical ice crampons
- Asymmetric design follows the contours of modern boots to ensure a precise fit
- Micro-adjustable linking bar with integrated heel piece for better torsional rigidity
- 3 front bail positions, 2 heel bail positions, 3 heel bail height settings
- Dynamic anti-balling plates included
- Adjustable fold-over carrying case with lashing straps included

The evolution of the Alpinist Pro, the Alpinist Tech features the aggressive functionality of a mono-point with a precisely positioned secondary point for extra support and stability. Designed for technical climbing at the highest level, the Alpinist Tech is also our lightest technical ice crampon making it a great choice for top level alpinism where the secondary point provides extra stability on hard snow and mixed terrain. The walking points also feature special auxiliary points that provide extra stability on funky ice petals and cauliflowers. Using much of the same technology and innovative design as the Blade Runner crampons, the Alpinist Tech ensures a precise fit on modern boots and extra rigidity in the connection between the heel and toe platforms. This is due to the unique heel slide that integrates the micro-adjustable linking bar with the heel piece for better torsional rigidity. Constructed entirely from chromoly steel for the best energy absorption anywhere the crampons might be stressed. The elimination of the connection joints leaves little room for play and reduces much of the flex that can make crampons seem less secure on technical terrain. The Alpinist Tech is delivered standard with automatic toe and heel bails, but can convert to semi-auto with the Semi-Auto Toe Bails (ref.2453C) and Semi-Auto Heel Bails (ref.2450C) sold separately. The micro-adjustable linking bar allows for fine-tuning of the length. The front bail can be set in three positions for optimally positioning the front points and the heel bail can be set in two positions for different size heel lasts. The heel bail also has three height settings for the most secure attachment to the boot. Dynamic anti-balling plates use a unique design and elastic material to prevent snow build-up underfoot.



ALPINIST PRO - AUTO / SEMI-AUTO

2449C

ALPINISM, ICE CLIMBING, MIXED CLIMBING

- The most advanced alpine ice crampons ever conceived
- Innovative heel slide design integrates the benefits of vertical and horizontal frame crampons
- Integrated ice points are optimized for vertical ice and steep, hard snow
- Asymmetric design follows the contours of modern boots to ensure a precise fit
- Delivered standard with automatic and semi-auto toe bails
- Dynamic anti-balling plates included
- Micro-adjustable linking bar for fine-tuning the length
- 3 front bail positions, 2 heel bail positions, 3 heel bail height settings
- Adjustable fold-over carrying case with lashing straps included

The Alpinist Pro optimizes the benchmark Alpinist crampons for the most technical alpine terrain. Using much of the same technology and innovative design as the Blade Runner crampons, the Alpinist ensures a precise fit with modern boots and extra rigidity in the connection between the heel and toe platforms. This is due to the unique heel slide that integrates the micro-adjustable linking bar with the heel piece for better torsional rigidity. Constructed entirely from chromoly steel for the best energy absorption anywhere the crampons might be stressed. The elimination of connection joints leaves little room for play and reduces much of the flex that can make crampons seem less secure on technical terrain. The sophisticated geometry of the integrated ice points interacts with the secondary points for superior hold in steep, hard snow and vertical ice. The Alpinist Pro is delivered standard with both automatic and semi-auto toe bails for optimal compatibility with boots and conditions. The micro-adjustable linking bar allows fine-tuning of the length. The front bail can be set in three positions for optimally positioning the front points and the heel bail can be set in two positions for different size heel lasts. The heel bail also has three height settings for the most secure attachment with the boot. Dynamic anti-balling plates use a unique design and elastic material to prevent snow build-up underfoot.

Ref.	Product name	Weight		Weight no antibott g	Size (*) European	Boot type		Points	Frame material	Antibott	CE EN 893
		g	oz			Automatic	Semi-Automatic				
2680C	ALPINIST TECH	810	28.6	689	36-48	•	• + Art.2453C + Art.2450C	11	NiCrMo Steel	Included	•
2449C	ALPINIST PRO - AUTO / SEMI-AUTO	960	33.9	842	36-48	•	•	12	NiCrMo Steel	Included	•

(*) Sizing varies depending on different boots, brands and models

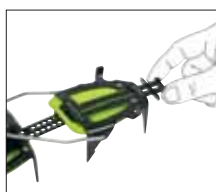
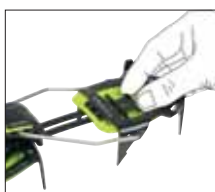

ASCENT - UNIVERSAL

2979

MOUNTAINEERING, ALPINISM

- Lightweight steel crampons for mountaineering
- Asymmetric design and flexible linking bar follow the contours of modern boots to ensure a precise fit
- Universal bindings are compatible with nearly any kind of mountaineering or hiking boot or shoe
- Binding parts are interchangeable between Auto/Semi-Auto/Universal (sold separately)
- Compact frame takes up less space in the pack
- Dynamic anti-balling plates included
- Micro-adjustable linking bar with large and small range settings allows for a precise fit without the use of tools
- Dyneema® linking straps (available separately) reduce weight and allow the crampons to fold onto themselves for tighter packability
- 2 front bail positions
- Adjustable fold-over carrying case with lashing straps included

The Ascent is a lightweight steel crampon for mountaineering. It uses a minimalist design to reduce weight without compromising performance. The compact frame is particularly rigid and the points are positioned for aggressive traction and maximum stability. Universal bindings are compatible with nearly any kind of boot or shoe. Binding parts are interchangeable between Auto/Semi-Auto/Universal (sold separately). The fit can be optimized with the micro-adjustable flexible linking bar. Dynamic anti-balling plates prevent snow build-up underfoot.

ASCENT - AUTO / SEMI-AUTO

2978

MOUNTAINEERING, ALPINISM

- Lightweight steel crampons for mountaineering
- Asymmetric design and flexible linking bar follow the contours of modern boots to ensure a precise fit
- Binding parts are interchangeable between Auto/Semi-Auto and Universal
- Compact frame takes up less space in the pack
- Delivered standard with automatic and semi-auto toe bails (Universal Heel sold separately)
- Dynamic anti-balling plates included
- Micro-adjustable linking bar with large and small range settings allows for a precise fit without the use of tools
- Dyneema® linking straps (available separately) reduce weight and allow the crampons to fold onto themselves for tighter packability
- 2 front bail positions, 2 heel bail positions, 3 heel bail height settings
- Adjustable fold-over carrying case with lashing straps included

The Ascent is a lightweight steel crampon for mountaineering. It uses a minimalist design to reduce weight without compromising performance. The compact frame is particularly rigid and the points are positioned for aggressive traction and maximum stability. The Ascent Auto/Semi-Auto is delivered standard with both automatic and semi-auto toe bails. Binding parts are interchangeable between Auto/Semi-Auto/Universal (sold separately). The fit can be optimized with the micro-adjustable flexible linking bar, 2 front bail positions, 2 heel bail positions and 3 heel bail height settings. Dynamic anti-balling plates prevent snow build-up underfoot.



Video:
Ascent Universal,
Ascent Auto / Semi-auto

Ref.	Product name	Weight		Weight no antibott	Size (*)	Boot type			Points	Frame material	Antibott	CE
		g	oz			g	European	 Automatic				
2979	ASCENT - UNIVERSAL	776	27.4	708	34-48	• + Art.2452 • + Art.2588	• + Art.2588	•	10	NiCrMo Steel	Included	•
2978	ASCENT - AUTO / SEMI-AUTO	728	25.7	660	34-48	•	•	• + Art.2988	10	NiCrMo Steel	Included	•

(*) Sizing varies depending on different boots, brands and models



STALKER - UNIVERSAL

292003

BEST SELLER

CC4U

MOUNTAINEERING, ALPINISM

- Our best-selling crampons
- Optimized fit for all types of boots with the new universal binding design
- Flexible linking bar and pre-shaped front platform adapt precisely while walking
- 12 points deliver a high level of performance on technical terrain
- Easy size adjustment requires no tools
- Dynamic anti-balling plates prevent snow build up
- Carrying case included

The Stalker crampon provides a precise fit on modern mountaineering boots and technical performance that only a true 12-point crampon can deliver. It is an excellent choice for safe travel in the mountains. Traditional chromoly steel construction is proven to stand the test of time and the universal binding with thermoplastic harnesses wrap around the boots and are secured by strong polyester straps. Dynamic anti-balling plates prevent snow build up



STALKER - SEMI-AUTOMATIC

292004

BEST SELLER

CC4U

MOUNTAINEERING, ALPINISM

- Semi-automatic bindings fit most technical mountaineering boots
- With a optimized fit profile for modern boots
- Flexible linking bar and pre-shaped front platform adapt precisely while walking
- 12 points deliver a high level of performance on technical terrain
- Easy size adjustment requires no tools
- Dynamic anti-balling plates prevent snow build up
- Carrying case included

The Stalker crampon provides a precise fit on modern mountaineering boots and technical performance that only a true 12-point crampon can deliver. It is an excellent choice for safe travel in the mountains. Traditional chromoly steel construction is proven to stand the test of time. Semi-automatic bindings deliver a precise fit on technical mountaineering boots with a welted heel. Dynamic anti-balling plates prevent snow build up

Ref.	Product name	Weight		Weight no antibott	Size (*)	Boot type			Points	Frame material	Antibott	CE
		g	oz			g	European	Automatic				
292003	STALKER - UNIVERSAL	895	31.6	800	36-48	•	•	•	12	NiCrMo Steel	Included	•
292004	STALKER - SEMI-AUTOMATIC	890	31.4	795	36-48	•	•	•	12	NiCrMo Steel	Included	•

(*) Sizing varies depending on different boots, brands and models



ROCKICE
BIG.
BEST IN GEAR

XLC NANOTECH - SEMI-AUTOMATIC

254402

CC4U

MOUNTAINEERING, ALPINISM, HIGH ALTITUDE

- Sandvik Nanoflex® stainless steel reinforcements on the front points
- 3-D pressed frame maximizes strength and performance
- Semi-automatic bindings fit most semi-rigid mountaineering boots
- Tool-free size adjustment
- CC4U wear indicators on the side points show when it is time for replacement
- Dynamic anti-balling plates and carrying case included

Semi-auto version of the XLC Nanotech. Features the same lightweight materials and construction as the hyperlight XLC crampons with the addition of innovative Sandvik Nanoflex® steel reinforcements on the front points for increased durability, strength, and penetration on hard ice and snow. The semi-automatic binding is designed for a secure fit on most semi-rigid mountaineering boots. For telemark or A/T boots, use the automatic bindings.



Sandvik Nanoflex® is an innovative steel alloy that is stronger and 25% harder than normal steel which allows for a significant reduction in the amount of metal used, thereby decreasing weight while maintaining strength.



ROCKICE
BIG.
BEST IN GEAR

XLC NANOTECH - AUTOMATIC

254403

CC4U

MOUNTAINEERING, SKI MOUNTAINEERING, ALPINISM, HIGH ALTITUDE

- Sandvik Nanoflex® stainless steel reinforcements on the front points
- 3-D pressed frame maximizes strength and performance
- Automatic bindings fit most technical mountaineering and telemark boots
- CC4U wear indicators on the side points show when it is time for replacement
- Dynamic anti-balling plates and carrying case included

The XLC Nanotech features the same lightweight materials and construction as the hyperlight XLC crampons with the addition of innovative Sandvik Nanoflex® steel reinforcements on the front points for increased durability, strength, and penetration on hard ice and snow. Automatic bindings offer the most secure fit for rigid boots with full toe and heel welts, including A/T and telemark boots.



Sandvik Nanoflex® is an innovative steel alloy that is stronger and 25% harder than normal steel which allows for a significant reduction in the amount of metal used, thereby decreasing weight while maintaining strength.

Ref.	Product name	Weight		Weight no antibott	Size (*)	Boot type			Points	Frame material	Antibott	CE
		g	oz			g	European	Automatic				
254402	XLC NANOTECH - SEMI-AUTOMATIC	650	22.9	571	36-48	•	•		12	7075 Aluminum / Nanoflex®	Included	•
254403	XLC NANOTECH - AUTOMATIC	560	19.8	481	36-47	•			12	7075 Aluminum / Nanoflex®	Included	•

(*) Sizing varies depending on different boots, brands and models



XLC 490 - UNIVERSAL

254201

CC4U

MOUNTAINEERING, HIGH ALTITUDE

- 3-D pressed frame maximizes strength and performance
- Universal bindings fit most mountaineering and hiking boots
- Tool-free size adjustment
- CC4U wear indicators on the side points show when it is time for replacement
- Dynamic anti-balling plates and carrying case included

The lightest 12-point strap-on crampons in the world! Perfect for glacier travel and general mountaineering. Thermoplastic heel and toe harnesses wrap around nearly any hiking and classic mountaineering boots and are secured by strong nylon straps and metal buckles. Innovative 3-D shaped construction (pressed - not just bent) on the front platform distributes pressure applied to one point across the entire platform significantly increasing the strength of the crampon. For telemark or A/T boots, use the XLC 390 with automatic bindings. While sturdy, aluminum crampons are not suitable for ice climbing or intensive mixed terrain.



XLC 470 - SEMI-AUTOMATIC

254202

CC4U

MOUNTAINEERING, HIGH ALTITUDE

- 3-D pressed frame maximizes strength and performance
- Semi-automatic bindings fit most semi-rigid mountaineering boots
- Tool-free size adjustment
- CC4U wear indicators on the side points show when it is time for replacement
- Dynamic anti-balling plates and carrying case included

Built on the same hyperlight platform as the XLC 390 with a semi-automatic binding to accommodate boots without a toe welt. Innovative 3-D shaped construction (pressed - not just bent) on the front platform distributes pressure applied to one point across the entire platform significantly increasing the strength of the crampon. The semi-automatic binding is designed for a secure fit on most semi-rigid mountaineering boots. For telemark or A/T boots, use the XLC 390 with automatic bindings. While sturdy, aluminum crampons are not suitable for ice climbing or intensive mixed terrain.



XLC 390 - AUTOMATIC

254203













SKI COMP

CC4U

MOUNTAINEERING, SKI MOUNTAINEERING, COMPETITIVE SKI MOUNTAINEERING, HIGH ALTITUDE

- The lightest 12-point crampons in the world
- 3-D pressed frame maximizes strength and performance
- Automatic bindings fit most rigid mountaineering, A/T, and telemark boots
- CC4U wear indicators on the side points show when it is time for replacement
- Dynamic anti-balling plates and carrying case included

The lightest 12-point crampons in the world! Absolutely perfect for ski mountaineering and glacier travel. Innovative 3-D shaped construction (pressed - not just bent) on the front platform distributes pressure applied to one point across the entire platform significantly increasing the strength and durability of the crampon. Automatic bindings offer the most secure fit for rigid boots with full toe and heel welts, including A/T and telemark boots. While sturdy, aluminum crampons are not suitable for ice climbing or intensive mixed terrain.

Ref.	Product name	Weight		Weight no antibott	Size (*)	Boot type			Points	Frame material	Antibott	CE
		g	oz			g	European	 Automatic				
254201	XLC 490 - UNIVERSAL	585	20.7	506	36-48				12	7075 Aluminum	Included	
254202	XLC 470 - SEMI-AUTOMATIC	575	20.3	496	36-48				12	7075 Aluminum	Included	
254203	XLC 390 - AUTOMATIC	490	17.3	411	36-47				12	7075 Aluminum	Included	

(*) Sizing varies depending on different boots, brands and models



SKIMO RACE

2584

LIGHT&FAST

SKI COMP



COMPETITIVE SKI MOUNTAINEERING

- Hyperlight 7075 aluminum alloy construction
- Automatic binding with our T-Stop toe system
- Semi-auto toe bails and heel bails are available separately for boots without toe welts
- The heel bail has been optimized to fit A/T ski boots and features 3 height settings for fine-tuning the fit
- Micro-adjustable linking bar with large and small range settings allows for a precise fit without the use of tools
- Dyneema® linking straps (available separately) reduce weight (330 g) and allow the crampons to fold onto themselves for tighter packability
- Anti-balling plates and carrying case included
- Torx key for adjustment included

The Skimo Race is a style of crampon that has been purpose-built for competitive ski mountaineering. Every detail has been optimized for lightweight and speed. The Skimo Race features our T-Stop toe system combined with a traditional snap on heel bail for fast and secure attachment to the boot. The micro-adjustable linking bar with large and small range settings delivers a precise fit for all boot lengths. The linking bar can also be replaced with the optional Dyneema® linking strap (sold separately) to reduce weight and allow the crampons to be folded onto themselves for tighter packability. Semi-auto toe bails and heel bails (sold separately) can be integrated for boots without toe welts. Anti-balling plates and carrying case included.



SKIMO NANOTECH

2586



SKI MOUNTAINEERING

- Hyperlight 7075 aluminum alloy construction
- Sandvik Nanoflex® stainless steel reinforcements on the front points
- Automatic binding with our T-Stop toe system
- Semi-auto toe bails are available separately for boots without toe welts
- The heel bail has been optimized to fit A/T ski boots and features 3 height settings for fine-tuning the fit
- Micro-adjustable linking bar with large and small range settings allows for a precise fit without the use of tools
- Dyneema® linking straps (available separately) reduce weight (375 g) and allow the crampons to fold onto themselves for tighter packability
- Anti-balling plates and carrying case included
- Torx key for adjustment included

The Skimo Nanotech uses the same hyperlight 7075 aluminum alloy frame design and T-Stop binding system as the Skimo Tour with the addition of Sandvik Nanoflex® stainless steel reinforcements on the front points for increased durability, strength, and penetration on hard snow and ice. The micro-adjustable linking bar with large and small range settings delivers a precise fit for all boot lengths. The linking bar can also be replaced with the optional Dyneema® linking strap (sold separately) to reduce weight and allow the crampons to be folded onto themselves for tighter packability. Semi-auto toe bails (sold separately) can be integrated for boots without toe welts. Anti-balling plates and carrying case included.

 Sandvik Nanoflex® is an innovative steel alloy that is stronger and 25% harder than normal steel which allows for a significant reduction in the amount of metal used, thereby decreasing weight while maintaining strength.

Ref.	Product name	Weight		Weight no antibott g	Size (*) European	Sole length		Boot type		Points	Frame material	Antibott	CE EN 893
		g	oz			mm	mm	Automatic	Semi-Automatic				
2584	SKIMO RACE	425	15.0	350	36-46	210-260	260-330	•	• + Art.2589 + Art.2588	10	7075 Aluminum	Included	•
2586	SKIMO NANOTECH	470	16.6	395	36-46	210-260	260-330	•	• + Art.2589	10	7075 Aluminum / Nanoflex®	Included	•

(*) Sizing varies depending on different boots, brands and models



SKIMO PURE NANOTECH

2981

LIGHT&FAST

1ST CLASS





SKI MOUNTAINEERING, COMPETITIVE SKI MOUNTAINEERING

- The lightest steel crampons in the world
- Designed for ski mountaineering and competitive ski mountaineering racers
- Constructed from Sandvik Nanoflex® stainless steel
- Automatic binding with T-Stop toe system
- Semi-auto toe bails are available separately for boots without toe welts
- The heel bail has been optimized to fit A/T ski boots and features 3 height settings for fine-tuning the fit
- Micro-adjustable linking bar with large and small range settings allows for a precise fit without the use of tools
- Dyneema® linking straps (available separately) reduce weight and allow the crampons to fold onto themselves for tighter packability
- Dynamic anti-balling plates and carrying case included
- Torx key for T-Stop adjustment included

The Skimo Pure Nanotech is a hyperlight steel crampon designed for ski mountaineering and competitive ski mountaineering racers. It uses the same frame design and T-Stop binding system as the Skimo Tour, but the frame is constructed entirely from Sandvik Nanoflex® stainless steel for a solid grip on hard snow and ice. The micro-adjustable linking bar with large and small range settings delivers a precise fit for all boot lengths. The linking bar can also be replaced with the optional Dyneema® linking strap (sold separately) to reduce weight and allow the crampons to be folded onto themselves for tighter packability. Semi-auto toe bails (sold separately) can be integrated for boots without toe welts. Dynamic anti-balling plates and carrying case included.

 Sandvik Nanoflex® is an innovative steel alloy that is stronger and 25% harder than normal steel which allows for a significant reduction in the amount of metal used, thereby decreasing weight while maintaining strength.

Ref.	Product name	Weight		Weight no antibott	Size (*)	Sole length		Boot type		Points	Frame material	Antibott	CE EN 893
		g	oz			g	European	 mm	 mm				
2981	SKIMO PURE NANOTECH	592	20.9	524	36-46	210-260	260-330	•	• + Art.2589	10	Nanoflex®	Included	•

(*) Sizing varies depending on different boots, brands and models

**BLADE RUNNER 0378
HEEL BAIL**

0257C 2 pcs



**BLADE RUNNER 0378
AUTOMATIC TOE BAIL**

0251C 2 pcs



**BLADE RUNNER 0378
SEMI-AUTO TOE BAIL**

0150C 2 pcs



**ANTIBOTT
BLADE RUNNER**

2987C 2 pcs



**BLADE RUNNER
FRONT POINT**

0145C 2 pcs



**BLADE RUNNER ALPINE
FRONT POINT**

0146C 2 pcs



ALPINIST TECH FRONT PART

2681C 2 pcs

Replacement front platform with integrated mono-point fits any model of Alpinist crampons.



ALPINIST PRO FRONT PART

2527C 2 pcs

Replacement front platform with integrated ice points fits any model of Alpinist crampon.

**BLADE RUNNER / ALPINIST
AUTOMATIC HEEL BAIL**

2683C 2 pcs



**BLADE RUNNER / ALPINIST
SEMI-AUTO HEEL BAIL**

2450C 2 pcs



**BLADE RUNNER / ALPINIST / ASCENT
AUTOMATIC TOE BAIL**

2452C 2 pcs



**BLADE RUNNER / ALPINIST
SEMI-AUTO TOE BAIL**

2453C 2 pcs



**ANTIBOTT
ALPINIST PRO**

2526C 2 pcs



**ANTIBOTT
ALPINIST TECH**

2682C 2 pcs





ASCENT / SKIMO DYNEEMA® LINKING STRAP

2596 2 pcs

Dyneema® linking strap for Skimo crampons. Replace the standard linking bar with the linking strap to reduce weight and allow the crampons to be folded onto themselves for tighter packability.

SKIMO / ASCENT HEEL BAIL

2588 2 pcs



SKIMO SEMI-AUTO TOE BAIL

2589 2 pcs



ANTIBOTT SKIMO

2587 2 pcs



ANTIBOTT SKIMO PURE NANOTECH

2997 2 pcs



ASCENT LINKING BAR

2994 2 pcs



SKIMO PURE NANOTECH LINKING BAR

2998 2 pcs

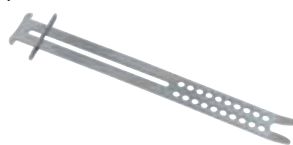

SKIMO LINKING BAR

2684 2 pcs



XLC ALUMINUM LINKING BAR

0095 2 pcs



STALKER FLEXIBLE LINKING BAR

2912 2 pcs



FOLDABLE CRAMPON BAG

2652C

Fold over carrying case constructed from strong and durable nylon. Expands and contracts to fit any size crampons. Features lashing straps for attaching to the exterior of a pack and an internal pocket with Velcro closure for tools and spare parts.



CRAMPON CASE

1385



SPIKE PROTECTOR

0379 2 pcs



**ANTIBOTT
ASCENT**

2993 2 pcs



**ANTIBOTT
STALKER**

2911 2 pcs



**ANTIBOTT XLC,
XLC NANOTECH**

2560 2 pcs



**STALKER SEMI-AUTOMATIC
HEEL BAIL**

2910 2 pcs



**AUTOMATIC HEEL BAIL
ALUMINUM**

1122 2 pcs



**SEMI-AUTO HEEL BAIL
ALUMINUM**

1123 2 pcs



**ASCENT UNIVERSAL
HEEL BAIL**

2988 2 pcs



**ASCENT SEMI-AUTO
TOE BAIL**

2992 2 pcs



ALUMINUM TOE BAIL

2117 2 pcs



TRACTION



The Ice Master Evo is the most reliable partner to explore the Sogndal woods, Norway © Veri Media

TRACTION

Attention to detail and purpose-built design always make the difference. Not only when it comes to high-level mountaineering tools like ice axes and crampons, but also in the less technical range of hiking products. The know-how acquired in the development of the more technical items always benefits the simpler ones. It is on this basis that the line of Ice Master anti-slip traction is born. No one single model for every situation; Ice Master is a range of differentiated products that are purpose-built for hikers, winter runners, general outdoor enthusiasts, and anyone who needs to prevent the dangerous risks of slipping. Ice Master traction devices can be easily put on and taken off of any kind of footwear providing grip when you need it and packing down for convenient transport when they are not needed.

ATTENTION: although Ice Master traction products are absolutely reliable for their specific use, in no case do they replace normal mountaineering crampons which remain the right solution on more technical terrain in the mountains and on glaciers.



Video:
Ice Master Run,
Ice Master Light,
Ice Master Evo

Traction



ICE MASTER
0173



ICE MASTER DISPLAY
0179



ICE MASTER EVO
3172



ICE MASTER EVO DISPLAY
3173



ICE MASTER LIGHT
3174



ICE MASTER LIGHT DISPLAY
3175



ICE MASTER RUN
3176



ICE MASTER RUN DISPLAY
3177



FROST
0656

ICE MASTER

- 0173 S 36/38 - Grey
- 0173 M 39/41 - Orange
- 0173 L 42/44 - Red
- 0173 XL 45/47 - Blue

HIKING, TREKKING

- Robust and easy to use traction device increases stability on snow, ice and other slippery surfaces
- Articulated front platform for a natural walking feel
- 13 powder coated steel 15 mm spikes are connected by durable galvanized steel chains
- Simple and safe elastomer binding system with a strap for maximum stability on the shoe
- Available in 4 sizes for shoes from size 36 to 47
- Hard case included

Reliable and robust traction device for use any time there is a danger of falling or slipping in the winter. The Ice Master is quick and easy to put on and take off with an easy-to-use elastomer binding system that stretches over the shoe. 13 steel points deliver a secure grip and the robust linking chains ensure a high level of strength and durability. Note: on technical terrain, the Ice Master does not replace the need for mountaineering crampons.



Grey



Orange



Red



Blue

Ref.	Product name	Size (*)	Weight		Points	Frame material	CE
		European	g	oz			
0173	ICE MASTER	S - 36/38	455	16.1	13	Carbon steel	•
		M - 39/41	478	16.9			
		L - 42/44	495	17.5			
		XL - 45/47	500	17.6			

(*) Sizing varies depending on different boots, brands and models



ICE MASTER DISPLAY

0179

- The display contains 16 sets of Ice Master: 2 S, 6 M, 6 L and 2 XL



ICE MASTER EVO

- 3172 S 36/38 - Purple
- 3172 M 39/41 - Orange
- 3172 L 42/44 - Light Blue
- 3172 XL 45/47 - Light Grey

BEST SELLER

HIKING, TREKKING

- Multi-purpose traction device increases stability on snow, ice and slippery terrain
- Articulated front platform for a natural walking feel
- 13 stainless steel 15 mm spikes are connected by durable chains of the same material
- Simple and safe elastomer binding system with a strap for maximum stability on the shoe
- Available in 4 sizes for shoes from size 36 to 47
- Hard case is functional and compact with ventilation holes to allow the product to dry

As the name suggests, the Ice Master Evo is the evolution of the popular and reliable Ice Master. It is designed for the most demanding users with 13 stainless steel spikes linked with high-quality stainless steel chains for exceptional strength and durability. The elastomer binding system is quick and easy to put on and take off, and the extra strap makes the attachment to the shoe especially stable. Note: on technical terrain, the Ice Master Evo does not replace the need for mountaineering crampons.

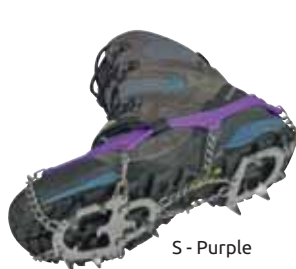

S - Purple



M - Orange



L - Light Blue



XL - Light Grey

Ref.	Product name	Size (*)	Weight		Points	Frame material	CE
		European	g	oz			
3172	ICE MASTER EVO	S - 36/38	425	15.0	13	Stainless steel	•
		M - 39/41	433	15.3			
		L - 42/44	442	15.6			
		XL - 45/47	450	15.9			

(*) Sizing varies depending on different boots, brands and models



ICE MASTER EVO DISPLAY

3173

- The display contains 16 sets of Ice Master Evo: 2 S, 6 M, 6 L and 2 XL

ICE MASTER LIGHT

- 3174 S 36/38 - Grey / Purple
- 3174 M 39/41 - Grey / Orange
- 3174 L 42/44 - Grey / Light Blue
- 3174 XL 45/47 - Grey / Light Grey

1ST CLASS

HIKING, TREKKING, LIFESTYLE

- Lightweight traction device increases stability on snow, ice and slippery terrain
- 13 stainless steel 13 mm spikes are evenly distributed under the sole of the shoe
- Lightweight elastomer binding system envelopes the foot for a performance fit, and special eyelets where the chains connect to the binding allow for optimal tensioning
- Integrated rear pull tab makes it easy to put on and remove
- Robust stainless steel connecting chains
- Available in 4 sizes for shoes from size 36 to 47
- Hard case is functional and compact with ventilation holes to allow the product to dry

The Ice Master Light is the optimal blend of lightweight and performance. Not only are they lighter weight, but they are also more compact. 13 stainless steel spikes are distributed evenly under the sole of the shoe to provide a secure grip and precise traction on snowy, icy and slippery surfaces. The innovative elastomer binding system is lightweight and envelopes the foot for a performance fit. Putting them on and taking them off is made easy with the integrated pull tab on the heel. For hikers who need to carry a traction device for those moments when they might need it, the Ice Master Light is the right choice. Note: on technical terrain, the Ice Master Light does not replace the need for mountaineering crampons



Ref.	Product name	Size (*)	Weight		Points	Frame material	CE
		European	g	oz			
3174	ICE MASTER LIGHT	S - 36/38	270	9.5	13	Stainless steel	•
		M - 39/41	278	9.8			
		L - 42/44	292	10.3			
		XL - 45/47	302	10.7			

(*) Sizing varies depending on different boots, brands and models



ICE MASTER LIGHT DISPLAY

3175

- The display contains 16 sets of Ice Master Light: 2 S, 6 M, 6 L and 2 XL



ICE MASTER RUN

- 3176 S 36/38 - Lime / Purple
- 3176 M 39/41 - Lime / Orange
- 3176 L 42/44 - Lime / Light Blue
- 3176 XL 45/47 - Lime / Light Grey

LIGHT&FAST

WINTER RUNNING, HIKING, TREKKING, LIFESTYLE

- Extremely lightweight traction device designed for winter running
- 13 stainless steel 8 mm spikes are evenly distributed under the sole of the shoe
- Lightweight elastomer binding system envelopes the foot for a performance fit, and special eyelets where the chains connect to the binding allow for optimal tensioning
- Integrated rear pull tab makes it easy to put on and remove
- Robust stainless steel linking micro-chains for a better feel under foot while running
- Available in 4 sizes for shoes from size 36 to 47
- Hard case is functional and compact with ventilation holes to allow the product to dry



8mm
x13
STAINLESS STEEL

A minimalist version of the Ice Master designed specifically for winter running. 13 stainless steel spikes are evenly distributed under the sole of the shoe for solid traction. The spikes are shortened to 8 mm and the connecting chains are a lower gauge for a better feel under foot while running. The innovative elastomer binding system is lightweight and envelopes the foot for a performance fit. Putting them on and taking them off is made easy with the integrated pull tab on the heel. For runners who need the extra grip to prevent dangerous slips and falls in the winter, the Ice Master Run is the purpose-built solution for you. Note: on technical terrain, the Ice Master Run does not replace the need for mountaineering crampons.



Lime / Purple



Lime / Orange



Lime / Light Blue



Lime / Light Grey

Ref.	Product name	Size (*)	Weight		Points	Frame material	CE
		European	g	oz			
3176	ICE MASTER RUN	S - 36/38	172	6.1	13	Stainless steel	•
		M - 39/41	178	6.3			
		L - 42/44	188	6.6			
		XL - 45/47	198	7.0			

(*) Sizing varies depending on different boots, brands and models



ICE MASTER RUN DISPLAY

3177

- The display contains 16 sets of Ice Master Run: 2 S, 6 M, 6 L and 2 XL



FROST

0656

HIKING, TREKKING

- 6-point steel crampon
- Easy adjust binding system with 2 ratchets
- Double-width adjustment fits a large range of shoes and boots
- Anti-balling plates and carrying case included

Compact 6-point steel crampons deliver precise traction for winter hiking and recreation. The Frost is worn under the mid-foot and heel to guarantee purchase especially when walking downhill where hikers are most prone to slipping. Double-width adjustment and 2-ratchet fast binding system fits a very large range of shoes and boots.

Ref.	Product name	Size (*)	Weight		Points	Frame material	Antibott	CE
		European	g	oz				
0656	FROST	36/47	555	19.6	6	NiCrMo Steel	Included	•

(*) Sizing varies depending on different boots, brands and models



The Dolomites are not only for rock climbing: Michael Maili in action on the "Pisciadù" waterfall (WI4+) on the north side of Sella group, Italy © Bigwall Productions

ICE SCREWS



ICE SCREWS

Like the other tools that make up the C.A.M.P. technical ice range, the Rocket and Rocket Plus are designed to do their job in the best way possible. C.A.M.P. already makes the absolute top-of-the-line ice axes and crampons. Now completing the triad of technical ice gear, the Rocket and Rocket Plus deliver this same top-level performance for ice screws.

Solid and Secure

Both the Rocket and Rocket Plus are made of chromium-molybdenum steel, with reverse angle threads for smooth driving and maximum holding power. The front teeth are engineered for the fastest and easiest placements even in the coldest, most compact ice. The Rocket Plus also has the benefit of being able to be placed and removed while clipped to the rope.

Lightweight

The Rocket Plus, equipped with a double loop of Dyneema® webbing on a free-spinning hanger eliminates the need to attach a quickdraw. Just rack it with a Photon Wire or Nano 22 carabiner and you have one of the lightest ice screw configurations on the market. The sling can also be carried directly on a Hub racking carabiner.



Ice screws



ROCKET XS 7 cm
3171C



ROCKET XS 9 cm
2999C



ROCKET 13 cm
298513C



ROCKET 16 cm
298516C



ROCKET 19 cm
298519C



ROCKET 22 cm
298522C



ROCKET PLUS 13 cm
298613C



ROCKET PLUS 16 cm
298616C



ROCKET PLUS 19 cm
298619C



3171C



2999C



Video

ROCKET XS

3171C 7 cm

2999C 9 cm

PAT. PEND.

ICE CLIMBING, ALPINISM

- Shorter versions (7 and 9 cm) of the Rocket ice screw for thin ice
- Lightweight, strong and durable chromoly steel construction
- Reverse angle threads for smooth driving and maximum holding power
- Front teeth engineered for the fastest and easiest placements even in the coldest, most compact ice
- Chromoly steel hanger aligns with the screw to pull in an optimal direction for maximum holding power and racks well on either side of the harness
- Fold out crank knobs are color coded for easy identification
- For progression only, not certified

The Rocket XS are two shorter versions of the Rocket ice screw for thin ice. The chromoly steel construction is lightweight, strong and durable. The front teeth have been engineered for the fastest placements even in the coldest, most compact ice. Reverse angle threads ensure smooth driving and maximum holding power. Compact chromoly steel hanger aligns with the screw to pull in an optimal direction and is designed to rack well on both sides of the harness. Fold out crank knobs are color coded for easy identification.

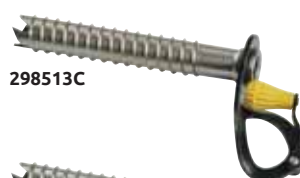

298513C



Video



298516C



298519C



298522C



ROCKET

298513C 13 cm

298516C 16 cm

298519C 19 cm

298522C 22 cm

PAT. PEND.

ICE CLIMBING, ALPINISM

- Top-level ice screws designed for advanced alpinists and ice climbers
- Lightweight, strong and durable chromoly steel construction
- Reverse angle threads for smooth driving and maximum holding power
- Front teeth engineered for the fastest and easiest placements even in the coldest, most compact ice
- Chromoly steel hanger aligns with the screw to pull in an optimal direction for maximum holding power and racks well on either side of the harness
- Fold out crank knobs are color coded for easy identification
- EN 568 certified

The Rocket is a top-level workhorse for alpinists and ice climbers who rely on their ice screws in big mountain terrain. The chromoly steel construction is lightweight, strong and durable. The front teeth have been engineered for the fastest placements even in the coldest, most compact ice. Reverse angle threads ensure smooth driving and maximum holding power. Compact chromoly hanger aligns with the screw to pull in an optimal direction and racks well on both sides of the harness. Fold out crank knobs are color coded for easy identification.



Ref.	Product name	Weight		Color	Material				CE EN 568
		g	oz		Screw	Hanger	Crank	Webbing	
3171C	ROCKET XS 7 cm	84	3.0	Black	CrMo Steel	NiCrMo Steel	Carbon steel		
2999C	ROCKET XS 9 cm	94	3.3	Red	CrMo Steel	NiCrMo Steel	Carbon steel		
298513C	ROCKET 13 cm	116	4.1	Yellow	CrMo Steel	NiCrMo Steel	Carbon steel		•
298516C	ROCKET 16 cm	130	4.6	Blue	CrMo Steel	NiCrMo Steel	Carbon steel		•
298519C	ROCKET 19 cm	142	5.0	Grey	CrMo Steel	NiCrMo Steel	Carbon steel		•
298522C	ROCKET 22 cm	155	5.5	Green	CrMo Steel	NiCrMo Steel	Carbon steel		•



298613C



Video

ROCKET PLUS

298613C 13 cm

298616C 16 cm

298619C 19 cm

1ST CLASS PAT. PEND.

ICE CLIMBING, ALPINISM

- Rocket ice screws with integrated Dyneema slings eliminate the need for a quickdraw
- Lightweight, strong and durable chromoly steel construction
- Reverse angle threads for smooth driving and maximum holding power
- Front teeth engineered for the fastest and easiest placements even in the coldest, most compact ice
- Chromoly steel hanger spins freely on the screw which allows the screw to be placed and removed while clipped to the rope
- Fixed Dyneema sling has two loops – the top loop is for racking and short fixing at anchors, the bottom loop is designed to be pre-equipped with a carabiner
- Fixed aluminum alloy levers for the fastest possible placements and differentiated color knobs for easy identification
- EN 568 certified

The Rocket Plus uses an integrated Dyneema sling to eliminate the need for a quickdraw. With a Nano 22 or a Photon Wire carabiner, it is one of the lightest ice screws in the world and has the benefit of being able to be placed and removed while clipped to the rope. The fixed Dyneema sling has two loops for easy operation. The top loop is for racking and short fixing at anchors and the bottom loop is designed to be pre-equipped with a carabiner. The chromoly steel construction is lightweight, strong and durable. The front teeth have been engineered for the fastest placements even in the coldest, most compact ice. Reverse angle threads ensure smooth driving and maximum holding power.



298616C



298619C



Ref.	Product name	Weight		Color	Material				CE EN 568
		g	oz		Screw	Hanger	Crank	Webbing	
298613C	ROCKET PLUS 13 cm	118	4.2	Yellow	CrMo Steel		Aluminum alloy	Dyneema®	•
298616C	ROCKET PLUS 16 cm	133	4.7	Blue	CrMo Steel		Aluminum alloy	Dyneema®	•
298619C	ROCKET PLUS 19 cm	144	5.1	Grey	CrMo Steel		Aluminum alloy	Dyneema®	•

POLES



Adventures in the Bolivian Andes with the typical "penitentes" that make progression difficult © Giacomo Meneghello

POLES

A collection of trekking poles with models that have been purpose-built for every kind of adventure. C.A.M.P. offers a wide range of poles from the burly Backcountry 3.0 to the hyperlight Laser that has been specifically designed for sky running races where lightweight and packability are critical. In between are advanced combinations of materials, technology, and adjustability that allow backcountry enthusiasts to find the perfect set of poles for their specific adventures. The new Laser W, Sonic Alu Evo W and Backcountry Carbon W are designed and profiled specifically for women, the Backcountry Ergo is purpose-built for the most technical mountain runners, the Piz Alu is a strong and lightweight full aluminum alloy pole for skimo crushers, the Megasonic is a super sturdy 'Z-pole', and the Backcountry Bamboo features a unique combination of natural and high-tech materials with carbon fiber, aluminum alloy and bamboo.

Telescoping

New	Ref.	Product name	Weight		Adjustable length		Collapsed length		N° of segments	Section		Material		Basket	
			g	oz	cm	in	cm	in		mm	in	Pole	Tip	mm	in
NEW	3466	LASER	310	10.9	60-135	23.6-53.2	60	23.6	3	∅ 17-15.8-14.6	∅ 0.67-0.62-0.57	7001 Aluminum	Carbide	∅ 30	∅ 1.18
NEW	3467	LASER W	296	10.4	58-125	22.8-49.2	58	22.8	3	∅ 17-15.8-14.6	∅ 0.67-0.62-0.57	7001 Aluminum	Carbide	∅ 30	∅ 1.18
	2621	BACKCOUNTRY CARBON 2.0	390	13.8	64-135	25.2-53.2	64	25.2	3	∅ 16-14-12	∅ 0.63-0.55-0.47	Carbon Fiber	Carbide	∅ 44 - 83	∅ 1.73 - 3.27
	3219	BACKCOUNTRY CARBON W	360	12.7	60-125	23.6-49.2	60	23.6	3	∅ 16-14-12	∅ 0.63-0.55-0.47	Carbon Fiber	Carbide	∅ 44 - 83	∅ 1.73 - 3.27
	3352	BACKCOUNTRY PRO 2.0	486	17.2	63-135	24.8-53.2	63	24.8	3	∅ 18-16-14	∅ 0.71-0.63-0.55	Carbon Fiber 7075 Aluminum	Carbide	∅ 44 - 83	∅ 1.73 - 3.27
	3218	BACKCOUNTRY ERGO	452	16.0	71-135	28.0-53.2	71	28.0	3	∅ 16-14-12	∅ 0.63-0.55-0.47	7075 Aluminum	Carbide	∅ 34 Dart	∅ 1.3 Dart
	3351	BACKCOUNTRY BAMBOO	424	15.0	63-135	24.8-53.2	63	24.8	3	∅ 16-14-12	∅ 0.63-0.55-0.47	Carbon Fiber - Bamboo 7075 Aluminum	Carbide	∅ 44 - 83	∅ 1.73 - 3.27
	3221	BACKCOUNTRY 3.0	542	19.1	64-135	25.2-53.2	64	25.2	3	∅ 18-16-14	∅ 0.71-0.63-0.55	6061 Aluminum	Carbide	∅ 44 - 83	∅ 1.73 - 3.27
	3410	SKI DROP	480	16.9	89-135	35.0-53.2	89	35.0	2	Drop 18x15 - 16x13	Drop 0.71x0.59 - 0.63x0.51	7001 Aluminum	Carbide	Winter	Winter
	3411	SKI DROP W	478	16.9	85-125	33.5-49.2	85	33.5	2	Drop 18x15 - 16x13	Drop 0.71x0.59 - 0.63x0.51	7001 Aluminum	Carbide	Winter	Winter
	3409	SKI TRACK	520	18.4	83-140	32.7-55.1	83	32.7	2	∅ 16-14	∅ 0.63-0.55	7075 Aluminum	Carbide	∅ 100	∅ 3.94

Foldable

Ref.	Product name	Weight		Assembled length		Packed length		N° of segments	Section		Material		Basket	
		g	oz	cm	in	cm	in		mm	in	Pole	Tip	mm	in
2623	CARBON MIX	444	15.7	110-130	43.3-51.2	36	14.2	5	∅ 18-16-14	∅ 0.71-0.63-0.55	Carbon Fiber - 7075 Aluminum	Carbide	∅ 44 - 83	∅ 1.73 - 3.27
2624	SKY CARBON EVO	410	14.5	115-135	45.3-53.2	36	14.2	5	∅ 16-14-12	∅ 0.63-0.55-0.47	Carbon Fiber - 7075 Aluminum	Carbide	∅ 37 - 53 - 86	∅ 1.46 - 2.09 - 3.39
3350	MEGASONIC	574	20.3	115-135	45.3-53.2	36	14.2	5	∅ 18-16-14	∅ 0.71-0.63-0.55	7075 Aluminum	Carbide	∅ 44 - 83	∅ 1.73 - 3.27
3354	SONIC ALU 2.0	492	17.4	115-135	45.3-53.2	36	14.2	5	∅ 16-14-12	∅ 0.63-0.55-0.47	7075 Aluminum	Carbide	∅ 34 Dart - 44 - 83	∅ 1.3 Dart - 1.73 - 3.27
3353	SONIC ALU EVO W	472	16.7	107-125	42.1-49.2	34	13.4	5	∅ 16-14-12	∅ 0.63-0.55-0.47	7075 Aluminum	Carbide	∅ 34 Dart - 44 - 83	∅ 1.3 Dart - 1.73 - 3.27
3220	XENON PRO 2.0	340	12.0	115	45.3	33	13	4	∅ 12	∅ 0.47	Alluminio 7075	Carbide	∅ 34 Dart	∅ 1.3 Dart
		350	12.4	120	47.2	34	13.4							
		360	12.7	125	49.2	35	13.8							
		370	13.1	130	51.2	36	14.2							
		380	13.4	135	53.2	37	14.6							

Fixed

Ref.	Product name	Weight		Length		Section		Material		Basket
		g	oz	cm	in	mm	in	Pole	Tip	
3412	PIZ ALU EVO	405	14.3	115	45.3	∅ 16	∅ 0.63	7075 Aluminum	Carbide	Winter
		415	14.6	120	47.2					
		425	15.0	125	49.2					
		435	15.4	130	51.2					
		445	15.7	135	53.2					
		455	16.1	140	55.1					
		465	16.4	145	57.1					

CATEGORY LEADERS



Telescoping



NEW
LASER
3466



NEW
LASER W
3467



BACKCOUNTRY
CARBON 2.0
2621



BACKCOUNTRY
CARBON W
3219



BACKCOUNTRY
PRO 2.0
3352



BACKCOUNTRY
ERGO
3218



BACKCOUNTRY
BAMBOO
3351



BACKCOUNTRY 3.0
3221



SKI DROP
3410



SKI DROP W
3411



SKI TRACK
3409

Fixed



PIZ ALU EVO
3412



CARBON MIX
2623



SKY CARBON
EVO
2624



MEGASONIC
3350



SONIC ALU 2.0
3354



SONIC ALU EVO W
3353



XENON PRO 2.0
3220

Foldable

POLES

Technical features on LASER W trekking pole



296 g
Our lightest trekking poles

Minimal wrist loops are soft and easy to adjust



Elongated EVA grips (19 cm) with strong plastic tops for a free, comfortable grip

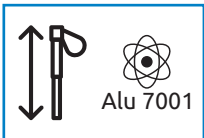

3-segment telescoping design constructed from aluminum alloy

LASER W
3467



Lightweight 'Rotating Lock' internal expansion locking system



Adjustable from 58 to 125 cm



Also available:
Laser ref. 3466 (60-135 cm)

30 mm fixed baskets



Carbide tips.
Rubber tip covers included.



LASER

3466

NEW

LIGHT&FAST

TREKKING, HIKING

- 3-segment telescoping design constructed from aluminum alloy
- Our lightest trekking poles
- Adjustable from 60 to 135 cm
- Elongated EVA grips (19 cm) with strong plastic tops for a free, comfortable grip
- Minimal wrist loops are soft and easy to adjust
- Lightweight 'Rotating Lock' internal expansion locking system
- Carbide tips
- 30 mm fixed baskets
- Rubber tip protectors included

Super light trekking poles for hikers who don't want to carry even one gram too many. The minimalist weight is accomplished with reduced sections in the aluminum tubing, minimalist wrist loops, reduced baskets and the internal 'Rotating Lock' adjustment system. The Laser is 60 cm long when closed and adjustable up to 135 cm. Aluminum alloy constructions still delivers the right levels of strength and durability. Carbide tips for the best traction and durability. Long EVA grips are comfortable and lightweight and have plastic tops to protect the ends.



LASER W

3467

NEW

LIGHT&FAST

TREKKING, HIKING

- 3-segment telescoping design constructed from aluminum alloy
- Our lightest trekking poles
- Adjustable from 58 to 125 cm
- Elongated EVA grips (19 cm) with strong plastic tops for a free, comfortable grip
- Minimal wrist loops are soft and easy to adjust
- Lightweight 'Rotating Lock' internal expansion locking system
- Carbide tips
- 30 mm fixed baskets
- Rubber tip protectors included

Super light trekking poles for hikers who don't want to carry even one gram too many. The minimalist weight is accomplished with reduced sections in the aluminum tubing, minimalist wrist loops, reduced baskets and the internal 'Rotating Lock' adjustment system. The Laser W is 58 cm long when closed and adjustable up to 125 cm. Aluminum alloy constructions still delivers the right levels of strength and durability. Carbide tips for the best traction and durability. Long EVA grips are comfortable and lightweight and have plastic tops to protect the ends.

Ref.	Product name	Weight		Adjustable length		Collapsed length		N° of segments	Section		Material		Basket	
		g	oz	cm	in	cm	in		mm	in	Pole	Tip	mm	in
3466	LASER	310	10.9	60-135	23.6-53.2	60	23.6	3	ø 17-15.8-14.6	ø 0.67-0.62-0.57	7001 Aluminum	Carbide	ø 30	ø 1.18
3467	LASER W	296	10.4	58-125	22.8-49.2	58	22.8	3	ø 17-15.8-14.6	ø 0.67-0.62-0.57	7001 Aluminum	Carbide	ø 30	ø 1.18



BACKCOUNTRY CARBON 2.0

2621

BEST SELLER

HIKING, MOUNTAINEERING, TREKKING

- Telescoping carbon fiber construction to reduce weight
- Extendable from 64 to 135 cm
- Graduated lower segments for easily setting the correct length
- Adjustable wrist loops are made in soft material and differentiated for right and left hands ("R" and "L") for optimal comfort
- Fast and secure locking system with an aluminum alloy clip makes adjustment quick and easy
- The tightening of the screw that adjusts the locking of the aluminum clip does not require the use of tools
- Carbide tips for the best traction and durability
- Rubber tip protectors included
- Supplied with small baskets (equipped as standard) and large baskets (included in the package) for use in every season

Carbon Fiber trekking poles are lightweight and offer great rigidity on technical terrain. Three telescoping segments extend from 64 to 135 cm with the fast and secure Alu Fast Lock adjustment. Molded plastic grips with a soft foam overlay combine with ergonomic wrist loops that are differentiated for right and left hands to ensure optimal comfort. Carbide tips for strength and durability. Interchangeable baskets for dirt or snow.



Video

BACKCOUNTRY CARBON W

3219

HIKING, MOUNTAINEERING, TREKKING

- Telescoping carbon fiber construction to reduce weight
- Extendable from 60 to 125 cm
- Graduated lower segments for easily setting the correct length
- Soft foam ergonomic grips are sized for smaller hands
- Adjustable wrist loops are made in soft material and differentiated for right and left hands ("R" and "L") for optimal comfort
- Fast and secure locking system with an aluminum alloy clip makes adjustment quick and easy
- The tightening of the screw that adjusts the locking of the aluminum clip does not require the use of tools
- Carbide tips for the best traction and durability
- Rubber tip protectors included
- Supplied with small baskets (equipped as standard) and large baskets (included in the package) for use in every season

Carbon Fiber trekking poles are lightweight and offer great rigidity on technical terrain. Three telescoping segments extend from 60 to 125 cm with the fast and secure Alu Fast Lock adjustment. The soft foam grips are sized for smaller hands. The lower segment is graduated to make it easy to set the correct length. The wrist straps are easy to adjust while moving and are differentiated for right and left hands for optimal comfort. Carbide tips for the best traction and durability.

Ref.	Product name	Weight		Adjustable length		Collapsed length		N° of segments	Section		Material		Basket	
		g	oz	cm	in	cm	in		mm	in	Pole	Tip	mm	in
2621	BACKCOUNTRY CARBON 2.0	390	13.8	64-135	25.2-53.2	64	25.2	3	ø 16-14-12	ø 0.63-0.55-0.47	Carbon Fiber	Carbide	ø 44 - 83	ø 1.73 - 3.27
3219	BACKCOUNTRY CARBON W	360	12.7	60-125	23.6-49.2	60	23.6	3	ø 16-14-12	ø 0.63-0.55-0.47	Carbon Fiber	Carbide	ø 44 - 83	ø 1.73 - 3.27



BACKCOUNTRY PRO 2.0

3352

TREKKING, MOUNTAINEERING, HIKING

- 3-segment telescopic trekking poles made from carbon fiber and aluminum alloy
- Graduated lower segments for easily dialing in the right length
- Double length foam handle with plastic top that allows gripping at different heights
- Adjustable wrist loops are made in soft material and differentiated for right and left hands ("R" and "L") for optimal comfort
- Variable length from 63 to 135 cm
- Quick and safe locking system with aluminum fast clips
- The tightening of the screw that adjusts the locking of the aluminum clip does not require the use of tools
- Carbide tips
- Rubber tip covers included
- Supplied with small baskets (equipped as standard) and large baskets (included in the package) for use in every season

The Backcountry Pro 2.0 is an extremely reliable trekking pole with a carbon fiber upper segment and aluminum alloy mid and lower segments for the right compromise between lightweight and strength. It is designed for intense hiking and longer, more demanding treks. The bottom segment is marked with graduations to dial in the length quickly and easily. The double length handles ensure excellent grip at different heights. Differentiated ergonomic wrist loops (right and left) further increase comfort. The tips are carbide for the best traction and durability.



Video



BACKCOUNTRY ERGO

3218

HIKING, TREKKING, TRAIL RUNNING

- Aluminum alloy trekking poles designed for trail running
- Articulated handle with an ergonomic grip helps with forward thrust and offloading weight
- Telescoping 3-segment aluminum alloy construction is sturdy and durable
- Reduced top segment to shave weight
- Graduated lower segments for easily setting the correct length
- Exclusive Dart Baskets are designed to provide extra stability around the tip on uneven terrain and prevent getting stuck in rocks
- Adjustable wrist loops are made in soft material and differentiated for right and left hands ("R" and "L") for optimal comfort
- Extendable from 71 to 135 cm
- Fast and secure locking system with an aluminum alloy clip makes adjustment quick and easy
- The tightening of the screw that adjusts the locking of the aluminum clip does not require the use of tools
- Carbide tips for the best traction and durability
- Rubber tip protectors included

The Backcountry Ergo is designed specifically for trail running where the poles need to adapt to the unique stresses of extra momentum and speed. Aluminum alloy construction delivers the right levels of sturdiness, strength and durability. The articulated handle is designed to help with forward thrust and to off-load weight while moving quickly. The wrist straps are easy to adjust while moving and are differentiated for right and left hands for optimal comfort. The exclusive Dart Baskets feature an innovative design that provides extra stability around the tip for uneven terrain like, and the unique profile helps prevent them from getting stuck between rocks. The lower segment is graduated to make it easy to set the correct length. Carbide tips for the best traction and durability.

Ref.	Product name	Weight		Adjustable length		Collapsed length		N° of segments	Section		Material		Basket	
		g	oz	cm	in	cm	in		mm	in	Pole	Tip	mm	in
3352	BACKCOUNTRY PRO 2.0	486	17.2	63-135	24.8-53.2	63	24.8	3	ø 18-16-14	ø 0.71-0.63-0.55	Carbon Fiber 7075 Aluminum	Carbide	ø 44 - 83	ø 1.73 - 3.27
3218	BACKCOUNTRY ERGO	452	16.0	71-135	28.0-53.2	71	28.0	3	ø 16-14-12	ø 0.63-0.55-0.47	7075 Aluminum	Carbide	ø 34 Dart	ø 1.3 Dart



BACKCOUNTRY BAMBOO

3351

TREKKING, MOUNTAINEERING, HIKING

- Very light 3-segment telescopic trekking poles made from bamboo, carbon fiber and aluminum alloy
- Graduated lower segments for easily dialing in the right length
- Ergonomic soft foam handle with cork top
- Adjustable wrist loops are made in soft material and differentiated for right and left hands ("R" and "L") for optimal comfort
- Variable length from 63 to 135 cm
- Quick and safe locking system with aluminum fast clips
- The tightening of the screw that adjusts the locking of the aluminum clip does not require the use of tools
- Carbide tips
- Rubber tip covers included
- Supplied with small baskets (equipped as standard) and large baskets (included in the package) for use in every season

A new concept of trekking pole with a unique combination of natural and high-tech materials. The middle segment is stiff, lightweight carbon fiber and the lower segment is aluminum alloy for maximum resistance. The upper segment is bamboo which is a wonderful natural material for trekking poles. It is lightweight and does not get cold to the touch. The bamboo also gives the poles a vintage look with elements of cork and wood. The bottom segment is marked with graduations to dial in the length quickly and easily. The handle is foam with a cork top for a very comfortable grip and differentiated ergonomic wrist loops (right and left) further increase comfort. The tips are carbide for the best traction and durability.



BACKCOUNTRY 3.0

3221

HIKING, MOUNTAINEERING, TREKKING

- Telescoping 3-segment aluminum alloy trekking poles are sturdy and extremely durable
- Graduated lower segments for easily setting the correct length
- Soft foam grips are ergonomically shaped for all-day comfort
- The top of the grip uses dense, grippy rubber for enhanced control and greater resistance to wear and tear
- Fast clip adjustable wrist loops are made in soft material and differentiated for right and left hands ("R" and "L") for optimal comfort and are easy to adjust while moving
- Extendable from 64 to 135 cm
- Fast and secure locking system with an aluminum alloy clip makes adjustment quick and easy
- The tightening of the screw that adjusts the locking of the aluminum clip does not require the use of tools
- Carbide tips for the best traction and durability
- Rubber tip protectors included
- Supplied with small baskets (equipped as standard) and large baskets (included in the package) for use in every season

The Backcountry 3.0 is designed for tireless hikers who need the maximum in stability, strength and durability. Aluminum alloy construction is sturdy and tough. Telescoping 3-segment design compacts to 64 cm when not in use. The lower segment is graduated to make it easy to set the poles at the correct length. The grip uses a unique blend of soft foam for the main part of the grip for all day comfort and a dense, grippy rubber on the top part of the grip for enhanced control and greater resistance to wear and tear. The wrist straps are easy to adjust while moving and are differentiated for right and left hands for optimal comfort. Carbide tips for the best traction and durability.

Ref.	Product name	Weight		Adjustable length		Collapsed length		N° of segments	Section		Material		Basket	
		g	oz	cm	in	cm	in		mm	in	Pole	Tip	mm	in
3351	BACKCOUNTRY BAMBOO	424	15.0	63-135	24.8-53.2	63	24.8	3	ø 16-14-12	ø 0.63-0.55-0.47	Carbon Fiber - Bamboo 7075 Aluminum	Carbide	ø 44-83	ø 1.73-3.27
3221	BACKCOUNTRY 3.0	542	19.1	64-135	25.2-53.2	64	25.2	3	ø 18-16-14	ø 0.71-0.63-0.55	6061 Aluminum	Carbide	ø 44-83	ø 1.73-3.27



SKI DROP

3410

SKI MOUNTAINEERING

- Two-part telescopic aluminum alloy poles
- Adjustable from 89 to 135 cm
- Lower segment graduated to easily identify the desired length
- Teardrop section for lighter weight and perfect basket-handle alignment
- Main grip is ergonomic for exceptional comfort and performance
- Long extension of grip material down the shaft for choking up on the poles on steep terrain
- Adjustable wrist loops are made in soft material and differentiated for right and left hands ("R" and "L") for optimal comfort
- Adjustment is managed with an aluminum alloy clip that is easy to operate while wearing gloves
- The tightening of the screw that adjusts the locking of the aluminum clip does not require the use of tools
- Innovative Winter Basket with an elongated shape for greater effectiveness in the snow, with carbide tip
- Rubber tip cover included

Telescopic aluminum pole designed for winter outdoor activities and in particular for ski mountaineering. The two-part construction guarantees the best combination of compactness and fast adjustment. The innovative teardrop section, in addition to reducing weight, ensures exceptional stability of the segments, preventing the lower one from rotating. In this way, the handle and the basket always remain perfectly aligned with each other, correctly oriented in the direction of progression. The new Winter Basket, characterized by an asymmetrical design that offers a large support surface and by an elongated shape with a carbide tip, is particularly effective on steep slopes (where it does not leverage on the snow). The Ski Drop is 89 cm long when closed and adjustable up to 135 cm thanks to the practical aluminum clip (convenient even when wearing gloves). The double handle allows grip at different heights, ensuring comfort and effectiveness on any terrain without having to lengthen or shorten the pole.



SKI DROP W

3411

SKI MOUNTAINEERING

- Two-part telescopic aluminum alloy poles
- Adjustable from 85 to 125 cm
- Lower segment graduated to easily identify the desired length
- Teardrop section for lighter weight and perfect basket-handle alignment
- Main grip is ergonomic for exceptional comfort and performance
- Long extension of grip material down the shaft for choking up on the poles on steep terrain
- Adjustable wrist loops are made in soft material and differentiated for right and left hands ("R" and "L") for optimal comfort
- Adjustment is managed with an aluminum alloy clip that is easy to operate while wearing gloves
- The tightening of the screw that adjusts the locking of the aluminum clip does not require the use of tools
- Innovative Winter Basket with an elongated shape for greater effectiveness in the snow, with carbide tip
- Rubber tip cover included

Telescopic aluminum pole designed for winter outdoor activities and in particular for ski mountaineering. The two-part construction guarantees the best combination of compactness and fast adjustment. The innovative teardrop section, in addition to reducing weight, ensures exceptional stability of the segments, preventing the lower one from rotating. In this way, the handle and the basket always remain perfectly aligned with each other, correctly oriented in the direction of progression. The new Winter Basket, characterized by an asymmetrical design that offers a large support surface and by an elongated shape with a carbide tip, is particularly effective on steep slopes (where it does not leverage on the snow). The Ski Drop W is 85 cm long when closed and adjustable up to 125 cm thanks to the practical aluminum clip (convenient even when wearing gloves). The double handle allows grip at different heights, ensuring comfort and effectiveness on any terrain without having to lengthen or shorten the pole.

Ref.	Product name	Weight		Adjustable length		Collapsed length		N° of segments	Section		Material		Basket	
		g	oz	cm	in	cm	in		mm	in	Pole	Tip	mm	in
3410	SKI DROP	480	16.9	89-135	35.0-53.2	89	35.0	2	Drop 18x15 - 16x13	Drop 0.71x0.59 - 0.63x0.51	7001 Aluminum	Carbide	Winter	Winter
3411	SKI DROP W	478	16.9	85-125	33.5-49.2	85	33.5	2	Drop 18x15 - 16x13	Drop 0.71x0.59 - 0.63x0.51	7001 Aluminum	Carbide	Winter	Winter



Video

SKI TRACK

3409

BEST SELLER

SKI MOUNTAINEERING

- New graphics and colors
- Two-part telescoping aluminum alloy poles for ski mountaineering and other winter activities
- Main grip is ergonomic for exceptional comfort and performance
- Long extension of grip material down the shaft for choking up on the poles on steep terrain
- Fast clip adjustable wrist loops are made in soft material and differentiated for right and left hands ("R" and "L") for optimal comfort and are easy to adjust while moving
- Adjustment is managed with an aluminum alloy clip that is easy to operate while wearing gloves
- The tightening of the screw that adjusts the locking of the aluminum clip does not require the use of tools
- Adjustable from 83 to 140 cm
- Carbide tip is uniquely designed to ensure great grip even on slippery surfaces
- Unique 'tilting wheel' basket tilts to create the best angle for maximum contact with the snow
- Rubber tip protectors included

The Ski Track is a two-part telescoping aluminum alloy pole designed for ski mountaineering. Adjustable from 83 to 140 cm with an aluminum alloy clip that is easy to operate while wearing gloves. The grip is designed for maximum comfort and a long extension of grip material allows skiers to choke up on the poles on steep terrain. The wrist loops are ergonomic and made in soft material for extra comfort. The tip is carbide for the best strength and durability and has been designed to ensure maximum grip on slippery surfaces. The unique 'tilting wheel' basket tilts to create the best angle for the maximum surface area contact with the snow for extra stability in deep snow on different angles.



PIZ ALU EVO

3412

SKI MOUNTAINEERING

- Fixed length aluminum alloy poles for ski mountaineering
- Extremely tough with a 16 mm tube diameter, ideal for frequent use
- Main grip is ergonomic for exceptional comfort and performance
- Long extension of grip material down the shaft for choking up on the poles on steep terrain
- Fast clip adjustable wrist loops are made in soft material and differentiated for right and left hands ("R" and "L") for optimal comfort and are easy to adjust while moving
- Available in 7 lengths from 115 to 145 cm
- Innovative Winter Basket with an elongated shape for greater effectiveness in the snow, with carbide tip
- Rubber tip cover included

The Piz Alu Evo is a fixed-length aluminum alloy pole designed to be a workhorse for ski mountaineering addicts. Skiers get the lightweight performance benefits of a fixed length pole, but with a robust 16 mm aluminum alloy tube construction for a level of strength and durability that race poles cannot deliver. The grip is designed for maximum comfort and a long extension of grip material allows skiers to choke up on the poles on steep terrain. The wrist loops are made in soft material and ergonomic for extra comfort. The new Winter Basket, characterized by an asymmetrical design that offers a large support surface and by an elongated shape with a carbide tip, is particularly effective on steep slopes (where it does not leverage on the snow).

Ref.	Product name	Weight		Adjustable length		Collapsed length		N° of segments	Section		Material		Basket	
		g	oz	cm	in	cm	in		mm	in	Pole	Tip	mm	in
3409	SKI TRACK	520	18.4	83-140	32.7-55.1	83	32.7	2	ø 16-14	ø 0.63-0.55	7075 Aluminum	Carbide	ø 100	ø 3.94
		405	14.3	115	45.3									
		415	14.6	120	47.2									
		425	15.0	125	49.2									
3412	PIZ ALU EVO	435	15.4	130	51.2			ø 16	ø 0.63	7075 Aluminum	Carbide		Winter	
		445	15.7	135	53.2									
		455	16.1	140	55.1									
		465	16.4	145	57.1									



CARBON MIX

2623

1ST CLASS

HIKING, TREKKING

- Foldable trekking poles for the best packability and fastest deployment
- Constructed from carbon fiber with aluminum alloy reinforcements at the joints
- 5 segments are linked with an inner cord that features a micro-adjustable tensioning system
- Soft foam double handle for excellent grip
- Adjustable wrist loops are made in soft material and differentiated for right and left hands ("R" and "L") for optimal comfort
- Fast and secure Alu Fast Lock adjustment system allows the poles to extend from 110 to 130 cm
- The tightening of the screw that adjusts the locking of the aluminum clip does not require the use of tools
- Compacts to 36 cm when disassembled
- Carbide tips for the best traction and durability
- Rubber tip protectors included
- Carrying case included
- Supplied with small baskets (equipped as standard) and large baskets (included in the package) for use in every season

Versatile trekking poles that feature the lightweight rigidity benefits of carbon fiber, the strength of aluminum alloy at the joints, tight packability from the foldable design, and adjustability from 110 to 130 cm with the fast and secure Alu Fast Lock adjustment system. The handle is ergonomic foam for optimal grip and extends down the shaft for choking up on technical terrain. The ergonomic wrist loops are differentiated for right and left hands to ensure optimal comfort. The tensioning cord is coated for fluid action and features a micro-adjustable tensioning system to fine-tune the tension over time. The upper segment features the fast and secure Alu Fast Lock adjustment system that allows the poles to be extended from 110 to 130 cm. Interchangeable baskets for dirt and snow.



SKY CARBON EVO

2624

LIGHT&FAST

HIKING, TRAIL RUNNING

- Constructed from carbon fiber on the upper segments and aluminum alloy on the bottom segment
- 5 segments are linked with an inner cord that features a micro-adjustable tensioning system
- Adjustable wrist loops are made in soft material and differentiated for right and left hands ("R" and "L") for optimal comfort
- Very easy to assemble and disassemble
- Fast and secure Alu Fast Lock adjustment system allows the poles to extend from 115 to 135 cm
- The tightening of the screw that adjusts the locking of the aluminum clip does not require the use of tools
- Compacts to 36 cm when disassembled
- Carbide tips for the best traction and durability
- Rubber tip protectors included
- Carrying case included

The Sky Carbon Evo trekking poles use carbon fiber on the upper segments and aluminum alloy on the bottom segment and joints for the best balance of weight, rigidity and strength. Molded plastic grips with a soft foam overlay combine with ergonomic wrist loops that are differentiated for right and left hands to ensure optimal comfort. The tensioning cord is coated for fluid action and features a micro-adjustable tensioning system to fine-tune the tension over time. The upper segment features the fast and secure Alu Fast Lock adjustment system that allows the poles to be extended from 115 to 135 cm. Interchangeable baskets for dirt and snow.

Ref.	Product name	Weight		Assembled length		Packed length		N° of segments	Section		Material		Basket	
		g	oz	cm	in	cm	in		mm	in	Pole	Tip	mm	in
2623	CARBON MIX	444	15.7	110-130	43.3-51.2	36	14.2	5	ø 18-16-14	ø 0.71-0.63-0.55	Carbon Fiber - 7075 Aluminum	Carbide	ø 44 - 83	ø 1.73 - 3.27
2624	SKY CARBON EVO	410	14.5	115-135	45.3-53.2	36	14.2	5	ø 16-14-12	ø 0.63-0.55-0.47	Carbon Fiber - 7075 Aluminum	Carbide	ø 37 - 53 - 86	ø 1.46 - 2.09 - 3.39



MEGASONIC

3350

TREKKING, MOUNTAINEERING, HIKING

- Foldable aluminum trekking poles
- 5 segments with internal cord equipped with a micro-adjustment system for tensioning
- Double length foam handle with plastic top that allows gripping at different heights
- Fast clip adjustable wrist loops are made in soft material and differentiated for right and left hands ("R" and "L") for optimal comfort and are easy to adjust while moving
- Easy to assemble and disassemble
- Easily adjustable from 115 to 135 cm with aluminum fast clips
- The tightening of the screw that adjusts the locking of the aluminum clip does not require the use of tools
- 36 cm folded length
- Carbide tips
- Rubber tip covers included
- Supplied with small baskets (equipped as standard) and large baskets (included in the package) for use in every season
- Compact carrying bag included

The Megasonic is a robust foldable trekking pole that features probe-style construction with larger segments to combine the practicality and compactness of the 'Z-pole' style with the rigidity and resistance of telescoping poles. Made entirely of aluminum alloy for strength and durability. The soft foam double handle has an ergonomic extension that ensures great grip at different heights. The wrist straps are easy to adjust while moving and are differentiated for right and left hands for optimal comfort. The internal cord is covered in plastic material for fluid assembly and disassembly. The micro-adjustment tensioning system guarantees a tight assembly and the upper segment is equipped with aluminum fast clips for quick, easy, and secure length adjustment.



SONIC ALU 2.0

3354

BEST SELLER

TREKKING, HIKING, TRAIL RUNNING

- Foldable aluminum alloy trekking poles
- 5 segments with internal cord equipped with a micro-adjustment system for tensioning
- Adjustable from 115 to 135 cm
- 36 cm folded length
- Double length foam handle allows gripping at different heights
- Adjustable wrist loops are made in soft material and differentiated for right and left hands ("R" and "L") for optimal comfort
- Easy to assemble and disassemble
- Easily adjustable with aluminum fast clips
- The tightening of the screw that adjusts the locking of the aluminum clip does not require the use of tools
- Carbide tips
- Rubber tip covers included
- Supplied with Dart baskets cod. 3225 (equipped as standard), small and large baskets (included in the package) for use in every season
- Compact carrying bag included

The Sonic Alu 2.0 is a versatile foldable trekking pole that is ideal for trail running. Constructed entirely from aluminum alloy with a double length foam handle for excellent grip at different heights and differentiated ergonomic wrist loops (right and left) for extra comfort. The internal cord is covered in plastic material for fluid assembly and disassembly. The micro-adjustment tensioning system guarantees a tight assembly and the upper segment is equipped with aluminum fast clips for quick, easy, and secure length adjustment. The exclusive Dart Basket that comes fitted as standard features an innovative design that provides a support surface around the tip on uneven or rocky ground without the risk of getting it stuck.

Ref.	Product name	Weight		Assembled length		Packed length		N° of segments	Section		Material		Basket	
		g	oz	cm	in	cm	in		mm	in	Pole	Tip	mm	in
3350	MEGASONIC	574	20.3	115-135	45.3-53.2	36	14.2	5	ø 18-16-14	ø 0.71-0.63-0.55	7075 Aluminum	Carbide	ø 44 - 83	ø 1.73 - 3.27
3354	SONIC ALU 2.0	492	17.4	115-135	45.3-53.2	36	14.2	5	ø 16-14-12	ø 0.63-0.55-0.47	7075 Aluminum	Carbide	ø 34 Dart - 44 - 83	ø 1.3 Dart - 1.73 - 3.27



SONIC ALU EVO W

3353

TREKKING, HIKING, TRAIL RUNNING

- Foldable aluminum alloy trekking poles
- 5 segments with internal cord equipped with a micro-adjustment system for tensioning
- Adjustable from 107 to 125 cm
- 34 cm folded length
- Double length foam handle allows gripping at different heights
- Adjustable wrist loops are made in soft material and differentiated for right and left hands ("R" and "L") for optimal comfort
- Easy to assemble and disassemble
- Easily adjustable with aluminum fast clips
- The tightening of the screw that adjusts the locking of the aluminum clip does not require the use of tools
- Carbide tips
- Rubber tip covers included
- Supplied with Dart baskets cod. 3225 (equipped as standard), small and large baskets (included in the package) for use in every season
- Compact carrying bag included

The Sonic Alu Evo W is a versatile foldable trekking pole that is ideal for trail running. Constructed entirely from aluminum alloy with a double length foam handle for excellent grip at different heights and differentiated ergonomic wrist loops (right and left) for extra comfort. The internal cord is covered in plastic material for fluid assembly and disassembly. The micro-adjustment tensioning system guarantees a tight assembly and the upper segment is equipped with aluminum fast clips for quick, easy, and secure length adjustment. The exclusive Dart Basket that comes fitted as standard features an innovative design that provides a support surface around the tip on uneven or rocky ground without the risk of getting it stuck.



XENON PRO 2.0

3220

LIGHT&FAST

HIKING, TRAIL RUNNING, RAID RACING

- Hyperlight and ultra-compact aluminum alloy trekking poles
- Assembles quickly with the pull of a Kevlar® cord
- Micro-adjustable tensioning system to fine-tune the tension of the Kevlar® cord
- Exclusive Dart Baskets are designed to provide extra stability around the tip on uneven terrain and prevent getting stuck in rocks
- Long soft foam grips for adapting to different angles of terrain
- Cord tension can be adjusted while walking
- Adjustable wrist loops
- Integrated Velcro webbing keeps the poles secured when folded
- Available in five lengths: 115, 120, 125, 130 and 135 cm
- Carbide tips
- Rubber tip protectors included

The Xenon 2.0 features a hyperlight and compact design with probe style construction that assembles quickly with the pull of a Kevlar® cord. The exclusive Dart Baskets feature an innovative design that provides extra stability around the tips on uneven terrain like talus and the unique profile helps prevent them from getting stuck between rocks. Long soft foam grips allow the user to hold the poles at various heights to adapt to different angles of terrain. Carbide tips for the best traction and durability. Not suitable for skiing.

Ref.	Product name	Weight		Assembled length		Packed length		N° of segments	Section		Material		Basket	
		g	oz	cm	in	cm	in		mm	in	Pole	Tip	mm	in
3353	SONIC ALU EVO W	472	16.7	107-125	42.1-49.2	34	13.4	5	ø 16-14-12	ø 0.63-0.55-0.47	7075 Aluminum	Carbide	ø 34 Dart - 44 - 83	ø 1.3 Dart - 1.73 - 3.27
		340	12.0	115	45.3	33	13							
3220	XENON PRO 2.0	350	12.4	120	47.2	34	13.4	4	ø 12	ø 0.47	Alluminio 7075	Carbide	ø 34 Dart	ø 1.3 Dart
		360	12.7	125	49.2	35	13.8							
		370	13.1	130	51.2	36	14.2							
		380	13.4	135	53.2	37	14.6							



LASER LOW SEGMENT

3468

NEW



LASER W LOW SEGMENT

3469

NEW



BACKCOUNTRY CARBON 2.0 SEGMENT

322801 Top Segment
322802 Mid Segment
322803 Low Segment



BACKCOUNTRY CARBON W SEGMENT

322901 Top Segment
322902 Mid Segment
322903 Low Segment



BACKCOUNTRY PRO 2.0 TOP SEGMENT

3347



BACKCOUNTRY PRO TOP SEGMENT

3230



BACKCOUNTRY BAMBOO SEGMENT

334601 Top Segment
334602 Mid Segments
334603 Low Segment



SKI TRACK LOW SEGMENT

3418



CARBON MIX SEGMENT

322701 Top Segment
322702 Mid Segments
322703 Low Segment



SKY CARBON EVO SEGMENT

322601 Top Segment
322602 Mid Segments
322603 Low Segment



BACKCOUNTRY BASKET

322301 Small - 10 g - 2 pcs
322302 Large - 28 g - 2 pcs

Replacement baskets for all Backcountry models and Carbon Mix, Megasonic, Sonic Alu 2.0, Sonic Alu Evo W and Xenon Pro 2.0. Sold in pairs.



SKY / SONIC BASKET

322201 Small - 8 g - 2 pcs
322202 Medium - 12 g - 2 pcs
322203 Large - 28 g - 2 pcs

Replacement baskets for Sky Carbon Evo. Sold in pairs.



PIZ BASKET

3178 38 g - 2 pcs

Replacement rigid baskets for Piz Alu. Sold in pairs.



DART BASKET

3225 12 g - 2 pcs

Replacement rigid baskets for Backcountry Carbon 2.0, Backcountry Carbon W, Backcountry Ergo, Backcountry Bamboo, Backcountry 3.0, Backcountry Pro, Carbon Mix, Megasonic, Sonic Alu 2.0, Sonic Alu Evo W and Xenon Pro 2.0. Sold in pairs.



WINTER BASKET

3413 50 g - 2 pcs

Replacement rigid baskets for Ski Drop, Ski Drop W and Piz Alu Evo. Characterized by an asymmetrical design that offers a large support surface and by an elongated shape with a carbide tip, they are particularly effective on steep slopes (where it does not leverage on the snow). Sold in pairs.



POLE TIP

3414 24 g - 2 pcs

Replacement tips for Backcountry Carbon 2.0, Backcountry Carbon W, Backcountry Pro 2.0, Backcountry Ergo, Backcountry Bamboo, Backcountry 3.0, Carbon Mix, Megasonic, Sonic Alu 2.0, Sonic Alu Evo W and Xenon Pro 2.0. Sold in pairs.



"Pilar Rojo" (450 m, 7a+) is a wonderful route on the east face of Aguja Mermoz (2732 m) in Patagonia. Alessandro Baù, Francesco Ratti, and Claudio Migliorini managed to climb it taking advantage of a single day of good weather © Claudio Migliorini

ROCK PROTECTION



ROCK PROTECTION

Icon... Improved

Tricams were invented by one of the greatest climbing minds of all time, Greg Lowe, who relied on the manufacturing and metallurgical expertise of C.A.M.P. to bring his ideas to market. Tricams remain an icon today modified only a few times in their history - first to update the slings with Dyneema® on the four most popular sizes, then to release two smaller sizes (white and black). The most recent innovation is the Tricam Evo that gives a third placement possibility making it even more versatile. The Tricam Evo is available in four sizes and can be placed in a cammed position or in one of two chocked positions. At the same time, our engineers spent some time working on one of the age-old questions with the Tricam... how to stiffen the sling without impeding its ability to engage the camming action. After much experimenting, we rested on the simple solution of carrying the inner band of webbing further towards the head and using a stitch pattern. The result is a naturally stiffer sling that makes one-handed placements easier, but still engages the cam in active mode and will even increase durability over sharp edges with the additional layer of material.



A Note on Ratings

It is common knowledge amongst climbers that the gear we use is only as good as the way we use it. The protection we rely on is only as good as the specific placement and the rock surrounding it. In order to objectively publish comparable ratings, all certified climbing gear is tested and rated according to strict standards. This means the strength ratings are best interpreted in a relative way rather than as absolutes. A rating of 5 kN, for example, means 5 kN when placed optimally and in accordance with the standard. Interpreting the ratings in this way allows climbers to compare gear from different manufacturers in an effective and objective way. Then beyond the ratings, climbers can use other factors like the company's history for quality and standards for manufacturing.



CATEGORY LEADERS



Ref.	Product name	Weight		Range Min		Range Max					CE	
		g	oz	mm	in	mm	in	Cam 1 (kN)	Chock 2 (kN)	Chock 3 (kN)	EN 12270	EN 12276
0972025	TRICAM EVO N.0.25	17	0.6	13.5	0.53	23	0.91	5	5	5	•	
097205	TRICAM EVO N.0.5	29	1.0	17	0.67	27	1.06	8	8	8	•	
097210	TRICAM EVO N.1	37	1.3	21	0.83	32	1.26	10	10	10	•	
097215	TRICAM EVO N.1.5	55	1.9	27	1.06	40	1.57	12	12	12	•	
0973	TRICAM EVO SET - 4 pcs	139	4.9								•	
092325	TRICAM N.2.5	77	2.7	32	1.26	48	1.89	15	14		•	
092330	TRICAM N.3	88	3.1	38	1.5	54	2.13	15	14		•	
092335	TRICAM N.3.5	112	4.0	41	1.61	60	2.36	15	15		•	
092340	TRICAM N.4	134	4.7	45	1.77	64	2.52	15	15		•	
092350	TRICAM N.5	122	4.3	57	2.24	89	3.5	15	15		•	
092360	TRICAM N.6	185	6.5	73	2.87	105	4.13	15	15		•	
092370	TRICAM N.7	287	10.1	92	3.62	140	5.51	15	15		•	
09470125	TRICAM N.0.125	10.5	0.4	10	0.39	16	0.63	3	2		•	
0947025	TRICAM N.0.25	19	0.7	13.5	0.53	22	0.87	5	5		•	
094705	TRICAM N.0.5	30	1.1	18	0.71	27	1.06	9	7		•	
094710	TRICAM N.1	38	1.3	21	0.83	32	1.26	10	8		•	
094715	TRICAM N.1.5	55	1.9	26	1.02	40	1.57	12	12		•	
094720	TRICAM N.2	57	2.0	29	1.14	45	1.77	14	14		•	
0974	TRICAM SET - 6 pcs	209	7.4								•	
0975	TRICAM DYNEEMA N.0.5	29	1.0	18	0.71	27	1.06	9	7		•	
	TRICAM DYNEEMA N.1	35	1.2	21	0.83	32	1.26	10	8			
	TRICAM DYNEEMA N.1.5	49	1.7	26	1.02	40	1.57	20	17			
	TRICAM DYNEEMA N.2	55	1.9	29	1.14	45	1.77					
3101	PRO NUT N.1	12	0.4	7	0.28	13	0.51		5		•	
	PRO NUT N.2	20	0.7	10	0.39	16	0.63		7			
	PRO NUT N.3	30	1.1	13	0.51	20	0.79		10			
	PRO NUT N.4	37	1.3	15	0.59	23	0.91					
	PRO NUT N.5	41	1.4	18	0.71	27	1.06					
103401	BALL NUT N.1	31	1.1	4	0.16	6.8	0.27		7		•	
103402	BALL NUT N.2	40	1.4	4.8	0.19	8.9	0.35		8		•	
103403	BALL NUT N.3	49	1.7	6.1	0.24	11.4	0.45		8		•	
103404	BALL NUT N.4	59	2.1	7.6	0.3	12.9	0.51		8		•	
103405	BALL NUT N.5	74	2.6	10.6	0.42	16	0.63		8		•	
1047	NUT KEY	59	2.1									

ROCK PROTECTION

Rock Protection



TRICAM EVO
0972



TRICAM EVO SET - 4 pcs
0973



TRICAM
0923 / 0947



TRICAM SET - 6 pcs
0974



TRICAM DYNEEMA® SET - 4 pcs
0975

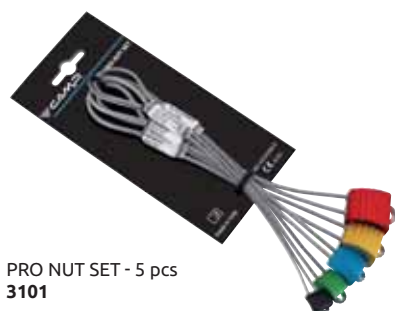

PRO NUT SET - 5 pcs
3101



BALL NUT
1034



NUT KEY
1047



097215



097210



097205

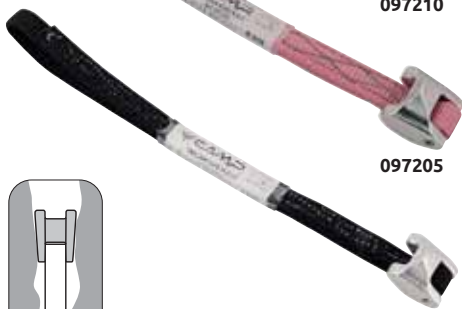

0972025

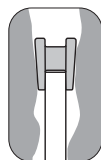

TRICAM EVO

0972

1ST CLASS

ALPINISM, ROCK CLIMBING, MULTI-PITCH CLIMBING

- Three (yes, that's one additional!) placement modes: active cam and 2 passive chocks
- Works where nothing else can fit, such as solution pockets
- Excellent in horizontal cracks
- Features stiffer sewing on the slings for easier one-handed placement and extraction

The Tricam Evo is a logical evolution of the tried & true, time-proven Tricam. Some simple engineering provides a second chock possibility giving the Tricam Evo three (instead of the historic two) placement possibilities making it even more versatile. The wider section at the top of the head that creates the extra taper will also lend additional stability in cammed placements. The Tricam Evo is available in four sizes from 0.25 to 1.5.

The Tricam Evo also features the stiffened slings where we carry the inner band of webbing further towards the head using a stitch pattern to create a naturally stiffer sling that makes one-handed placements easier, but still engages the cam in active mode and will even increase durability over sharp edges with the additional layer of material.

Ref.	Product name	Weight		Range Min		Range Max		Cam 1 (kN)	Chock 2 (kN)	Chock 3 (kN)	EN 12270
		g	oz	mm	in	mm	in				
0972025	TRICAM EVO N.0.25	17	0.6	13.5	0.53	23	0.91	5	5	5	•
097205	TRICAM EVO N.0.5	29	1.0	17	0.67	27	1.06	8	8	8	•
097210	TRICAM EVO N.1	37	1.3	21	0.83	32	1.26	10	10	10	•
097215	TRICAM EVO N.1.5	55	1.9	27	1.06	40	1.57	12	12	12	•



TRICAM EVO SET - 4 pcs

0973

ALPINISM, ROCK CLIMBING, MULTI-PITCH CLIMBING

Includes all four sizes of the Tricam Evo that feature three (instead of the historic two) placement possibilities making it even more versatile than the traditional Tricam. Sizes: 0.25, 0.5, 1.0, 1.5.

TRICAM

0923/0947

ALPINISM, ROCK CLIMBING, MULTI-PITCH CLIMBING

- Two placement modes: active cam and passive chock
- Works where nothing else can fit, such as solution pockets
- Excellent in horizontal cracks
- Stiffer sewing on the slings of sizes 0.125 – 2.0 for easier one-handed placement and extraction

Look on the rack of most experienced trad climbers and you are almost certain to see an assortment of Tricams. Most climbers agree that visiting the Gunks without multiples of pink through purple is a serious mistake. These wondrous pieces of pro can be used either as cams or nuts and often work where nothing else fits. Tricams are ideal in horizontal cracks, pockets, and shallow vertical cracks. The larger sizes are an affordable way to augment a rack of cams and are ideal for belay anchors due to their high strength and light weight. Tricams can also be placed in icy cracks where regular cams do not work.

Our engineers recently spent some time working on one of the age-old questions with the Tricam ... how to stiffen the sling without impeding its ability to engage the camming action. After much experimenting, we rested on the simple solution of carrying the inner band of webbing further towards the head and using a stitch pattern. The result is a naturally stiffer sling that makes one-handed placements easier, but still engages the cam in active mode and will even increase durability over sharp edges with the additional layer of material.



092370

092360

092350



092340

092335

092330



092325

094720

094715





094710

094705

0947025

09470125

Ref.	Product name	Weight		Range Min		Range Max				CE
		g	oz	mm	in	mm	in	Cam 1 (kN)	Chock 2 (kN)	EN 12270
092325	TRICAM N.2.5	77	2.7	32	1.26	48	1.89	15	14	•
092330	TRICAM N.3	88	3.1	38	1.5	54	2.13	15	14	•
092335	TRICAM N.3.5	112	4.0	41	1.61	60	2.36	15	15	•
092340	TRICAM N.4	134	4.7	45	1.77	64	2.52	15	15	•
092350	TRICAM N.5	122	4.3	57	2.24	89	3.5	15	15	•
092360	TRICAM N.6	185	6.5	73	2.87	105	4.13	15	15	•
092370	TRICAM N.7	287	10.1	92	3.62	140	5.51	15	15	•
09470125	TRICAM N.0.125	10.5	0.4	10	0.39	16	0.63	3	2	•
0947025	TRICAM N.0.25	19	0.7	13.5	0.53	22	0.87	5	5	•
094705	TRICAM N.0.5	30	1.1	18	0.71	27	1.06	9	7	•
094710	TRICAM N.1	38	1.3	21	0.83	32	1.26	10	8	•
094715	TRICAM N.1.5	55	1.9	26	1.02	40	1.57	12	12	•
094720	TRICAM N.2	57	2.0	29	1.14	45	1.77	14	14	•



TRICAM SET - 6 pcs

0974

ALPINISM, ROCK CLIMBING, MULTI-PITCH CLIMBING

The ultimate rack of go-to pieces. Sizes: 0.125, 0.25, 0.5, 1.0, 1.5, 2.0. Features the stiffened slings where we carry the inner band of webbing further towards the head using a stitch pattern to create a naturally stiffer sling that makes one-handed placements easier, but still engages the cam in active mode and will even increase durability over sharp edges with the additional layer of material.



TRICAM DYNEEMA® SET - 4 pcs

0975

ALPINISM, ROCK CLIMBING, MULTI-PITCH CLIMBING

By popular demand, the most popular Tricam sizes are also available with Dyneema® slings. These are slightly stronger in camming mode without adding any additional weight and realize the unique benefits of Dyneema®. Compared to nylon, Dyneema® maintains a higher breaking strength when wet and its natural hydrophobic properties prevent the slings from soaking up water and icing over. Sizes: 0.5, 1.0, 1.5, 2.0.



PRO NUT SET - 5 pcs

3101

BEST SELLER

ALPINISM, ROCK CLIMBING, MULTI-PITCH CLIMBING

- Curved design provides secure placements and easy removal
- Grooves help with setting and extraction in hard stone
- Color-coded heads for faster selection

A set of Pro Nuts covering the essential range of nuts for the modern trad rack.

Ref.	Product name	Weight		Range Min		Range Max		Cam 1 (kN)	Chock 2 (kN)	CE EN 12270
		g	oz	mm	in	mm	in			
0975	TRICAM DYNEEMA N.0.5	29	1.0	18	0.71	27	1.06	9	7	•
	TRICAM DYNEEMA N.1	35	1.2	21	0.83	32	1.26	10	8	
	TRICAM DYNEEMA N.1.5	49	1.7	26	1.02	40	1.57	20	17	
	TRICAM DYNEEMA N.2	55	1.9	29	1.14	45	1.77			
3101	PRO NUT N.1	12	0.4	7	0.28	13	0.51	5	7	•
	PRO NUT N.2	20	0.7	10	0.39	16	0.63			
	PRO NUT N.3	30	1.1	13	0.51	20	0.79			
	PRO NUT N.4	37	1.3	15	0.59	23	0.91	10		
	PRO NUT N.5	41	1.4	18	0.71	27	1.06			





BALL NUT

1034

ROCK CLIMBING, AID CLIMBING, ALPINISM

- The smallest active protection in the world!
- Color-coded for fast identification
- Narrow depth fits shallower cracks than traditional camming units

For the slim and grim. Invented in 1987 by Steve Byrne and originally brought to market as Low Balls, these have become the secret weapon of many aid and trad climbers. These little wonders will work in small parallel-sided cracks where the only other option is pounding a piton. Ball Nuts also work in pin scars and small flares where even modern micro cams simply won't fit. Since they weigh so little, many advanced trad climbers keep a #2 and #3 on their rack at all times.

Ref.	Product name	Weight		Range Min		Range Max			
		g	oz	mm	in	mm	in		
103401	BALL NUT N.1	31	1.1	4	0.16	6.8	0.27	7	•
103402	BALL NUT N.2	40	1.4	4.8	0.19	8.9	0.35	8	•
103403	BALL NUT N.3	49	1.7	6.1	0.24	11.4	0.45	8	•
103404	BALL NUT N.4	59	2.1	7.6	0.3	12.9	0.51	8	•
103405	BALL NUT N.5	74	2.6	10.6	0.42	16	0.63	8	•



NUT KEY

1047

ALPINISM, ROCK CLIMBING

- Chromoly steel
- Chrome-plated to prevent rust

Nut tools seldom get much respect, as apparent by a lot of mediocre designs that are too flexible or have poor ergonomics. Our Nut Key is a clear exception with an offset handle that offers superior clearance for easier poking and a thumb ledge for better control. Comfort is improved by finger notches and the rubber coating on the handle.

Ref.	Product name	Weight	
		g	oz
1047	NUT KEY	59	2.1

PITONS



Ines Papert and Luka Lindič on their route "Wolke 7" (380 m, 8a) in the Berchtesgaden Alps, Germany © Klaus Fengler

PITONS

Pitons



LOST ARROW
0130



CORNER
0096



UNIVERSAL
0088



KNIFEBLADE
0089



SOFT FIX RING
0087



SOFT UNIVERSAL
0152



CAPTAIN HOOK
3036C



IRON HAWK
3037C



BABY ANGLE
3039C



ULTIMATE REALITY PITON
3038C



ALUMINUM FIFI HOOK
3043C



BRENTA
0850



HAMMER LEASH REWIND
0854



HAMMER HOLDER
0853

Ref.	Product name	Weight		Total length		Blade length		Thickness		Material	CE
		g	oz	mm	in	mm	in	mm	in		EN 569
013001	LOST ARROW N.1	84	3.0	85	3.35	45	1.77	5	0.2	Hardened Steel	Progression
013002	LOST ARROW N.2	94	3.3	90	3.54	55	2.17	7	0.28	Hardened Steel	Progression
013003	LOST ARROW N.3	105	3.7	100	3.94	60	2.36	8	0.31	Hardened Steel	Progression
013004	LOST ARROW N.4	110	3.9	110	4.33	70	2.76	10	0.39	Hardened Steel	Progression
013005	LOST ARROW N.5	95	3.4	117	4.61	80	3.15	5.5	0.22	Hardened Steel	Progression
013006	LOST ARROW N.6	102	3.6	125	4.92	85	3.35	7	0.28	Hardened Steel	Progression
013007	LOST ARROW N.7	114	4.0	130	5.12	90	3.54	9	0.35	Hardened Steel	Safety
013008	LOST ARROW N.8	110	3.9	155	6.1	115	4.53	7.5	0.3	Hardened Steel	Safety
009601	CORNER N.1	56	2.0	105	4.13	70	2.76	12	0.47	Hardened Steel	Progression
009602	CORNER N.2	65	2.3	110	4.33	75	2.95	16	0.63	Hardened Steel	Progression
009603	CORNER N.3	95	3.4	145	5.71	110	4.33	18	0.71	Hardened Steel	Safety
009604	CORNER N.4	118	4.2	140	5.51	110	4.33	25	0.98	Hardened Steel	Safety
0088-12	UNIVERSAL 10 cm	63	2.2	100	3.94	60	2.36	6	0.24	Hardened Steel	Progression
0088-14	UNIVERSALE 12.5 cm	84	3.0	125	4.92	85	3.35				Safety
0088-17	UNIVERSAL 15 cm	108	3.8	150	5.91	110	4.33	3	0.12	Hardened Steel	Progression
0089-7	KNIFE BLADE 7.5 cm	54	1.9	75	2.95	35	1.38				Safety
0089-9	KNIFE BLADE 9 cm	58	2.0	90	3.54	50	1.97	7	0.28	Soft Steel	Progression
0089-10	KNIFE BLADE 10 cm	68	2.4	100	3.94	60	2.36				Safety
0087-10	SOFT FIX RING 10 cm	83	2.9	100	3.94	60	2.36	8	0.31	Soft Steel	Progression
0087-12	SOFT FIX RING 12 cm	95	3.4	120	4.72	80	3.15				Safety
0087-14	SOFT FIX RING 14 cm	129	4.6	140	5.51	90	3.54	6	0.24	Soft Steel	Progression
0087-16	SOFT FIX RING 15.5 cm	130	4.6	155	6.10	110	4.33				Safety
0152-10	SOFT UNIVERSAL 10 cm	63	2.2	100	3.94	60	2.36	6	0.24	Soft Steel	Progression
0152-12	SOFT UNIVERSAL 12.5 cm	85	3.0	125	4.92	85	3.35				Safety
0152-15	SOFT UNIVERSAL 15 cm	104	3.7	150	5.91	110	4.33				
303601C	CAPTAIN HOOK - Small	23	0.8							NiCrMo Steel	
303602C	CAPTAIN HOOK - Medium	32	1.1							NiCrMo Steel	
303603C	CAPTAIN HOOK - Large	52	1.8							NiCrMo Steel	
3037C	IRON HAWK	31	1.1							NiCrMo Steel	
303901C	BABY ANGLE - Small	43	1.5	28						NiCrMo Steel	
303902C	BABY ANGLE - Medium	49	1.7	38						NiCrMo Steel	
303903C	BABY ANGLE - Large	61	2.2	38						NiCrMo Steel	
3038C	ULTIMATE REALITY PITON	18	0.6							NiCrMo Steel	
304301C	ALUMINUM FIFI HOOK - Polished	15	0.5							Aluminum alloy	
304303C	ALUMINUM FIFI HOOK - Orange	15	0.5							Aluminum alloy	
0850	BRENTA	683	24.1							NiCrMo Steel	
0854	HAMMER LEASH REWIND	37	1.3							Nylon	
0853	HAMMER HOLDER	24	0.8							Nylon	



LOST ARROW

013001 8.5 cm	013005 11.5 cm
013002 9 cm	013006 12.5 cm
013003 10 cm	013007 13 cm
013004 11 cm	013008 15.5 cm

1ST CLASS

ALPINISM, AID CLIMBING, ROCK CLIMBING

- Chromoly steel

The historic Lost Arrow is the most prevalent kind of piton climbers are likely to find securing lines from Yosemite to Patagonia. Their simple straight-flare design provides a solid hold in both vertical and horizontal positions. Available in eight sizes.



CORNER

009601 10.5 cm
009602 11 cm
009603 14.5 cm
009604 14 cm

ALPINISM, AID CLIMBING, ROCK CLIMBING

- Chromoly steel

Most pitons rely on compression of the metal and leverage from directional pull for their holding power. The U shape of the shaft on the Corner piton adds an additional holding force by creating spring tension when the piton is driven into a crack proportionately smaller than its width.



UNIVERSAL

0088-12 10 cm
0088-14 12.5 cm
0088-17 15 cm

ALPINISM, AID CLIMBING, ROCK CLIMBING

- Chromoly steel

The pointed wedge shape of the Universal piton fits the most common cracks. A 45° angled head applies torque to maximize holding power for both vertical and horizontal placements.

Ref.	Product name	Weight		Total length		Blade length		Thickness		Material	CE
		g	oz	mm	in	mm	in	mm	in		EN 569
013001	LOST ARROW N.1	84	3.0	85	3.35	45	1.77	5	0.2	Hardened Steel	Progression
013002	LOST ARROW N.2	94	3.3	90	3.54	55	2.17	7	0.28	Hardened Steel	Progression
013003	LOST ARROW N.3	105	3.7	100	3.94	60	2.36	8	0.31	Hardened Steel	Progression
013004	LOST ARROW N.4	110	3.9	110	4.33	70	2.76	10	0.39	Hardened Steel	Progression
013005	LOST ARROW N.5	95	3.4	117	4.61	80	3.15	5.5	0.22	Hardened Steel	Progression
013006	LOST ARROW N.6	102	3.6	125	4.92	85	3.35	7	0.28	Hardened Steel	Progression
013007	LOST ARROW N.7	114	4.0	130	5.12	90	3.54	9	0.35	Hardened Steel	Safety
013008	LOST ARROW N.8	110	3.9	155	6.1	115	4.53	7.5	0.3	Hardened Steel	Safety
009601	CORNER N.1	56	2.0	105	4.13	70	2.76	12	0.47	Hardened Steel	Progression
009602	CORNER N.2	65	2.3	110	4.33	75	2.95	16	0.63	Hardened Steel	Progression
009603	CORNER N.3	95	3.4	145	5.71	110	4.33	18	0.71	Hardened Steel	Safety
009604	CORNER N.4	118	4.2	140	5.51	110	4.33	25	0.98	Hardened Steel	Safety
0088-12	UNIVERSAL 10 cm	63	2.2	100	3.94	60	2.36	6	0.24	Hardened Steel	Progression
0088-14	UNIVERSALE 12.5 cm	84	3.0	125	4.92	85	3.35				Safety
0088-17	UNIVERSAL 15 cm	108	3.8	150	5.91	110	4.33				Safety



KNIFE BLADE

0089-7 7.5 cm

0089-9 9 cm

0089-10 10 cm

ALPINISM, AID CLIMBING

- Chromoly steel

Tapered pitons designed to fit extremely thin cracks of various depths. Two carabiner holes increase clipping options and reduce weight.



SOFT FIX RING

0087-10 10 cm

0087-12 12 cm

0087-14 14 cm

0087-16 15.5 cm

ALPINISM, AID CLIMBING, ROCK CLIMBING

- Carbon steel
- Ideal for brittle rock like limestone

Designed to drive into the thinnest cracks. The soft carbon steel can mold and press more easily into fissures without damaging the rock making soft pitons the right choice for brittle rock like limestone.



SOFT UNIVERSAL

0152-10 10 cm

0152-12 12.5 cm

0152-15 15 cm

BEST SELLER

ALPINISM, AID CLIMBING, ROCK CLIMBING

- Soft carbon steel
- Ideal for brittle rock like limestone

The pointed wedge shape of the Universal piton fits the most common cracks. A 45° angled head applies torque to maximize holding power for both vertical and horizontal placements. The soft carbon steel can mold and press more easily into fissures without damaging the rock making soft pitons the right choice for brittle rock like limestone.

Ref.	Product name	Weight		Total length		Blade length		Thickness		Material	CE EN 569
		g	oz	mm	in	mm	in	mm	in		
0089-7	KNIFE BLADE 7.5 cm	54	1.9	75	2.95	35	1.38			Hardened Steel	Progression
0089-9	KNIFE BLADE 9 cm	58	2.0	90	3.54	50	1.97	3	0.12		
0089-10	KNIFE BLADE 10 cm	68	2.4	100	3.94	60	2.36				
0087-10	SOFT FIX RING 10 cm	83	2.9	100	3.94	60	2.36	7	0.28	Soft Steel	Progression
0087-12	SOFT FIX RING 12 cm	95	3.4	120	4.72	80	3.15				Safety
0087-14	SOFT FIX RING 14 cm	129	4.6	140	5.51	90	3.54	8	0.31		
0087-16	SOFT FIX RING 15.5 cm	130	4.6	155	6.10	110	4.33				
0152-10	SOFT UNIVERSAL 10 cm	63	2.2	100	3.94	60	2.36			Soft Steel	Progression
0152-12	SOFT UNIVERSAL 12.5 cm	85	3.0	125	4.92	85	3.35	6	0.24		
0152-15	SOFT UNIVERSAL 15 cm	104	3.7	150	5.91	110	4.33				



CAPTAIN HOOK

303601C Small
303602C Medium
303603C Large

AID CLIMBING

- Narrow (5 mm, 0.2"), chisel-shaped tooth maximizes holding power
- Chromoly steel

A wide tripod base makes these hooks remarkably stable during dicey aid moves. Due to the way they hang on the rack, these hooks are also less prone to snagging than other designs.



IRON HAWK

3037C

AID CLIMBING

- Fits cracks ranging from 1 mm (0.14") to 3.5 mm (0.14")
- Chromoly steel

A cross between a piton and a passive nut for almost non-existent vertical cracks. The Iron Hawk can be pounded in or set by hand and it drives deeper as it is weighted. It has a large anvil for hammering and a small lip to help with removal.



BABY ANGLE

303901C Small
303902C Medium
303903C Large

ALPINISM, AID CLIMBING

- Chromoly steel

These tiny angle pitons are invaluable for protecting shallow cracks and old pin scars. No need to hacksaw and grind regular angles, we've done it for you!



ULTIMATE REALITY PITON

3038C

AID CLIMBING

- Thickness tapers from 0.5 mm (0.02") to 1.5 mm (0.06")
- Chromoly steel
- Swaged steel cable

When faced with incipient cracks, the Ultimate Reality Piton is the weapon of choice. It has a large anvil for hammering and a small lip to help with removal.

Ref.	Product name	Weight		Total length		Material
		g	oz	mm	in	
303601C	CAPTAIN HOOK - Small	23	0.8			NiCrMo Steel
303602C	CAPTAIN HOOK - Medium	32	1.1			NiCrMo Steel
303603C	CAPTAIN HOOK - Large	52	1.8			NiCrMo Steel
3037C	IRON HAWK	31	1.1			NiCrMo Steel
303901C	BABY ANGLE - Small	43	1.5	28		NiCrMo Steel
303902C	BABY ANGLE - Medium	49	1.7	38		NiCrMo Steel
303903C	BABY ANGLE - Large	61	2.2	38		NiCrMo Steel
3038C	ULTIMATE REALITY PITON	18	0.6			NiCrMo Steel



ALUMINUM FIFI HOOK

304301C Polished
304303C Orange

AID CLIMBING

Lighter weight versions of the classic Fifi made of 7075 aluminum alloy. Anodized in two different colors for easy identification.

304301

304303



BRENTA

0850

ALPINISM, AID CLIMBING, ROCK CLIMBING

- Hot-forged chromoly steel with chrome plating to prevent rust
- Elastic rewind leash included

The Brenta is a compact hammer with a large face and good heft in the head for quickly driving home pitons. The pick is designed for cleaning cracks, pasting heads, and levering out pitons. The chromoly steel shaft is indestructible and the thick rubber grip dampens vibrations.



HAMMER LEASH REWIND

0854 37 g

ALPINISM, ROCK CLIMBING, AID CLIMBING

Elasticized rewind webbing leash for securing a hammer to a harness. A loop of cord is used to girth hitch the hammer and a small connector rated to 20 kg attaches to the harness.



HAMMER HOLDER

0853 24 g

ALPINISM, ROCK CLIMBING, AID CLIMBING

Can be attached securely to any size belt or harness. Durable nylon webbing construction.

Ref.	Product name	Weight		Material
		g	oz	
304301C	ALUMINUM FIFI HOOK - Polished	15	0.5	Aluminum alloy
304303C	ALUMINUM FIFI HOOK - Orange	15	0.5	Aluminum alloy
0850	BRENTA	683	24.1	NiCrMo Steel
0854	HAMMER LEASH REWIND	37	1.3	Nylon
0853	HAMMER HOLDER	24	0.8	Nylon



CARABINERS & QUICKDRAWS



After series of 9a and 9a+ sends, Stefano Carnati sent "Erebor" (9b) on April 16, 2023 in the Eremo di San Paolo, Arco, Italy. Stefano, a top athlete from the Ragni di Lecco group of climbers and alpinists, has become the fifth climber to send the epic route first freed by Stefano Ghisolfi © Michele Caminati

CARABINERS & QUICKDRAWS

The evolution continues. In 1987, C.A.M.P. released the first truly hyperlight carabiner at 33 grams. In 2005 we released the Nano Wire as the modern benchmark for lightweight functionality. Three years later we carved 5 grams out of the Nano Wire, introducing the Nano 23. In 2014 we were proud to shave one more gram with the Nano 22 ... the evolution continues! This kind of sustained innovation is only possible with ongoing development in the areas of materials and engineering, places where C.A.M.P. continues to set the bar with new products. Specific improvements with the Nano 22 include an increase in strength of 1 kN in all three configurations, a new nose that helps protect the wire, and a redesigned rope bearing surface that helps prolong the lifespan of the carabiner. The Photon family remains the prime choice for alpinists and climbers who want lightweight and full size. The Dyon is a unique wire gate carabiner with a new innovative keylock closure. All three models are brilliant for racking cams. If you plan to clip directly into the racking carabiner on steep splitters or anywhere you are wearing gloves, the Photon and Dyon reign supreme. For alpine rock, rack with Nanos to cut weight and reduce the amount of space they take up on gear loops. In addition to these top-of-the-line models, the best-selling Orbit carabiners and quickdraws have also been updated with the SphereLock closure and a new lightweight, functional shape.

HMS Optimization. C.A.M.P. HMS carabiners have been notable historically for shapes that optimize their performance with ropes and lightweight, utilitarian designs for big route climbers. With the Atom, Core, Nimbus and Nitro carabiners, we have again taken the opportunity to improve our tried and true designs. Exemplary characteristics include: lightweight and extremely easy to handle, new locking nuts with smooth action and channeled grooves for better grip, optimized rope bearing surfaces for unparalleled smooth handling and exceptional durability, laser etched markings to indicate if the gate is locked, and SphereLock closures for the slimmest nose profile to make rigging easier. The four shapes are purpose-built for different users so every climber can find the right carabiner for their specific style of climbing. The oversized design of the Atom makes it particularly easy to handle. The rounded shape of the Core gives it the most fluid action with ropes. The lightweight design of the Nitro makes it great for big routes. The compact shape of the Nimbus makes it extremely versatile.





Cut the Cross Load. C.A.M.P. quickdraws are equipped with dogbones that feature the exclusive Karstop Evo carabiner retention system, an innovative thermoplastic polyurethane keeper that is integrated into the dogbone with more precision and sophistication than the designs climbers have been used to seeing fail after a small amount of use. The system creates the widest possible contact area with the carabiner to keep shifting to the absolute minimum and the design even protects the dogbone from the rock thereby increasing its durability and safety.

Unique design. For belay carabiners, C.A.M.P. integrates a secondary gate within the body of the Atom Belay Lock and the Core Belay Lock carabiner that gets its spring action from the same spring as the main gate. The system is designed to help eliminate the dangers of cross loading by locking the carabiner securely in place along its major axis on the harness belay loop. The Dyon features our KeyWire system that joins a wire gate with our unique SphereLock closure system for a much more profiled nose than other 'snag-free' wire gate designs. SphereLock is a unique design that changes the shape of the interface between the gate and nose to a spherical shape to tighten up the union and significantly reduce the nose profile for easier clipping and cleaning. SphereLock is utilized in the Dyon, Photon, Orbit, Atom, Core, Nimbus and Nitro carabiners.

Organizing. Uniformity in the gear we use is one of the best ways to increase efficiency and performance while climbing. Look at the highest-performing climbers executing precise leads. Those red points are not random. They require perfect execution with the rack organized around each specific placement. The same is true of the hardest onsights and the biggest, boldest routes. Uniformity with gear makes first-time placements easier and re-racking during transitions at belays faster. So our recommendation (and the way in which you will see we have organized our range) is specificity. Be specific



CATEGORY LEADERS

				
LIGHT&FAST 1ST CLASS	LIGHT&FAST 1ST CLASS	LIGHT&FAST	LIGHT&FAST	BEST SELLER
NITRO LOCK 2928	PHOTON LOCK 2931	NANO 22 2335	PHOTON WIRE EXPRESS KS DYNEEMA® 3452/2883	ORBIT EXPRESS KS 3454/3455/2894U/3363U

about which carabiners you use on the gear end versus the rope end, individually rack cams and explore ways to color coordinate. These are simple things most climbers can do to organize around efficiency in the effort to increase performance.

Carabiner classifications and markings according to EN 12275 and EN 362 standards

- **Type B:** Basic connector. Self-closing connector for use anywhere in a belay system.
 - **Type H:** HMS connector. Self-closing connector – generally pear shaped – intended to be used primarily for dynamic belaying, for example using an “Italian hitch” (HMS).
 - **Type K:** Klettersteig connector. Self-closing connector intended to be used primarily for linking a mountaineer to a Klettersteig anchor (via ferrata) system.
 - **Type T:** Termination connector. Self-closing connector designed to ensure that the loading is in a pre-determined direction.
 - **Type A:** Specific anchor connector. Self-closing connector designed only to be linked directly to a specific class of anchor.
 - **Type Q:** Screwed-closure connector (quicklink). Connector which is closed by a screw-motion gate which is a load bearing part of the connector when fully screwed up.
 - **Type X:** Oval connector. Self-closing connector with symmetric shape designed for e.g. aid climbing and pulleys.
- Type M: Multi-use connector. Screw gate connector that may be loaded on the major and minor axis.

New	Ref.	Product name	Weight		kN		mm		Material	CE		121		
			g	oz	kN	kN	mm	mm		EN 12275	EN 362			
	2460	DYON	33	1.2	21	7	11	26	100	60	Aluminum alloy	B		
	2335	NANO 22	22	0.8	21	8	9	17	86	52	Aluminum alloy	B		
	246701	PHOTON STRAIGHT GATE	36	1.3	22	7	9	21	100	60	Aluminum alloy	B		
	2468	PHOTON BENT GATE	36	1.3	22	7	9	25	100	60	Aluminum alloy	B		
NEW	2931	PHOTON LOCK	43	1.5	23	8	9	17	102	63	Aluminum alloy	B		
	2470	PHOTON WIRE	30	1.1	22	8	9	26	100	62	Aluminum alloy	B		
	248303	ORBIT STRAIGHT GATE	42	1.5	24	7	8	20	98	58	Aluminum alloy	B		
	248403	ORBIT BENT GATE	42	1.5	24	7	8	25	98	58	Aluminum alloy	B		
	248507	ORBIT WIRE	36	1.3	22	7	8	27	98	61	Aluminum alloy	B		
	2929	ORBIT LOCK	45	1.6	24	8	8	17	98	58	Aluminum alloy	B	B	
	2921	ATOM LOCK	82	2.9	26	11	8	24	120	78	Aluminum alloy	H	B	
	2924	ATOM BELAY LOCK	85	3.0	24	11	8	24	120	78	Aluminum alloy	H	B	
	2922	ATOM 2LOCK	88	3.1	26	11	8	24	120	78	Aluminum alloy	H	B	
	2923	ATOM 3LOCK	88	3.1	26	11	8	24	120	78	Aluminum alloy	H	B	
	2928	NITRO LOCK	56	2.0	22	9	6	24	106	75	Aluminum alloy	H		
	2925	CORE LOCK	81	2.9	23	11	6	25	114	77	Aluminum alloy	H	B	
	2926	CORE BELAY LOCK	84	3.0	22	11	6	25	114	77	Aluminum alloy	H	B	
NEW	2927	NIMBUS LOCK	69	2.4	21	9	6	22	101	71	Aluminum alloy	H	B	
	137304	ATLAS LOCK	87	3.1	40	10	13	22	120	68	Aluminum alloy	B	B	
	137404	ATLAS 2LOCK	92	3.2	40	10	13	22	120	68	Aluminum alloy	B	B	
	137504	ATLAS 3LOCK	92	3.2	40	10	13	22	120	68	Aluminum alloy	B	B	
	130903	GUIDE LOCK	77	2.7	32	10	10	18	112	63	Aluminum alloy	B	B	
	136303	GUIDE XL LOCK	82	2.9	28	9	8	23	117	75	Aluminum alloy	B	B	
	136403	GUIDE XL 2LOCK	86	3.0	28	9	8	24	117	75	Aluminum alloy	B	B	
	136503	GUIDE XL 3LOCK	86	3.0	28	9	8	24	117	75	Aluminum alloy	B	B	
	2126	OVAL XL	66	2.3	28	11	7	22	110	62	Aluminum alloy	B		
	2123	OVAL XL LOCK	71	2.5	28	11	7	19	110	62	Aluminum alloy	B	B	
	2124	OVAL XL 2LOCK	76	2.7	28	11	7	19	110	62	Aluminum alloy	B	B	
	2125	OVAL XL 3LOCK	77	2.7	28	11	7	19	110	62	Aluminum alloy	B	B	
	1115	OVAL COMPACT LOCK	71	2.5	24	10	7	15	106	57	Aluminum alloy	X	B	
	127001	GYM SAFE	110	3.9	24	8	13	24	99	58	Carbon steel	B		
	0995	HERCULES	125	4.4	30	9	16	23	140	71	Aluminum alloy	K	T	•
	240701	NOMAD	88	3.1	25	8	9	29	131	76	Aluminum alloy	K		
	3141	TRIAD LOCK	84	3.0	20	16	8	16	103	73	Aluminum alloy	B	M	
	3142	TRIAD 3LOCK	88	3.1	20	16	8	16	103	73	Aluminum alloy	B	M	
	0981	OVAL STANDARD LOCK	165	5.8	28	7	10	16	108	58	Carbon steel		B	
	1455	OVAL PRO LOCK	180	6.4	30	15	9	17	109	56	Carbon steel	B	B	
	1878	OVAL PRO 2LOCK	200	7.1	30	15	9	17	109	56	Carbon steel	B	B	
	1456	OVAL PRO 3LOCK	210	7.4	30	15	9	17	109	56	Carbon steel	B	B	
	1877	D PRO LOCK	250	8.8	50	15	18	24	114	72	Carbon steel	B	B	
	187701	D PRO 2LOCK	270	9.5	50	15	18	24	114	72	Carbon steel	B	B	
	187702	D PRO 3LOCK	280	9.9	50	15	18	24	114	72	Carbon steel	B	B	
	0939	OVAL QUICK LINK STAINLESS 8 mm	76	2.7	50	10		9	74	39	Stainless steel	Q	Q	
	0949	OVAL QUICK LINK STAINLESS 10 mm	145	5.1	50	10		12	89	47	Stainless steel	Q	Q	
	0929	OVAL MINI LINK STAINLESS 5 mm	21	0.7	25			6	50	25	Stainless steel			
	0934	OVAL QUICK LINK STEEL 8 mm	81	2.9	40	10		9	74	39	Carbon steel	Q	Q	
	0935	OVAL QUICK LINK STEEL 10 mm	143	5.0	45	10		12	89	47	Carbon steel	Q	Q	
	0991	DELTA QUICK LINK STAINLESS 8 mm	85	3.0	35	10		10	73	56	Stainless steel	Q	Q	
	0992	DELTA QUICK LINK STAINLESS 10 mm	156	5.5	45	10		12	87	69	Stainless steel	Q	Q	
	0955	DELTA QUICK LINK STEEL 8 mm	88	3.1	30	10		10	73	56	Carbon steel	Q	Q	
	0961	DELTA QUICK LINK STEEL 10 mm	164	5.8	40	10		12	87	69	Carbon steel	Q	Q	
	0691	D QUICK LINK STEEL 10 mm	157	5.5	48	13		12	86	69	Carbon steel	Q	Q	
	0671	D QUICK LINK ALU 12 mm	125	4.4	25	16		14	107	85	Aluminum alloy	Q	Q	

CARABINERS & QUICKDRAWS

Carabiners



DYON
2460



DYON RACK PACK
2651



NANO 22
2335



NANO 22 RACK PACK
2479



PHOTON STRAIGHT GATE
246701



PHOTON BENT GATE
2468



PHOTON LOCK
2931
NEW



PHOTON LOCK 3 PACK
3433
NEW



PHOTON WIRE
2470



PHOTON WIRE RACK PACK
2469



ORBIT STRAIGHT GATE
248303



ORBIT BENT GATE
248403



ORBIT WIRE
248507



ORBIT LOCK
2929



ORBIT LOCK 3 PACK
2930



ATOM LOCK
2921



ATOM BELAY LOCK
2924



ATOM 2LOCK
2922



ATOM 3LOCK
2923



NITRO LOCK
2928



CORE LOCK
2925



CORE BELAY LOCK
2926



NIMBUS LOCK
2927
NEW



NIMBUS LOCK 3 PACK
3434
NEW



ATLAS LOCK
137304



ATLAS 2LOCK
137404



ATLAS 3LOCK
137504

Carabiners



GUIDE LOCK
130903



GUIDE XL LOCK
136303



GUIDE XL 2LOCK
136403



GUIDE XL 3LOCK
136503



OVAL XL
2126



OVAL XL LOCK
2123



OVAL XL 2LOCK
2124



OVAL XL 3LOCK
2125



OVAL COMPACT LOCK
1115



GYM SAFE
127001



HERCULES
0995



NOMAD
2407



TRIAD LOCK
3141



TRIAD 3LOCK
3142



OVAL STANDARD LOCK
0981



OVAL PRO LOCK
1455



OVAL PRO 2LOCK
1878



OVAL PRO 3LOCK
1456



D PRO LOCK
1877



D PRO 2LOCK
187701



D PRO 3LOCK
187702



OVAL QUICK LINK
STAINLESS
0929/0939/0949



OVAL QUICK LINK
STEEL
0934/0935



DELTA QUICK LINK
STAINLESS
0991/0992



DELTA QUICK LINK
STEEL
0955/0961



D QUICK LINK
STEEL
0691



D QUICK LINK
ALU
0671

CARABINERS & QUICKDRAWS

Quickdraws



NEW
DYON EXPRESS KS
3445/2466



NEW
DYON EXPRESS
KS 6 PACK
3446/2875



NEW
DYON MIXED EXPRESS KS
3447/2877



NEW
DYON MIXED EXPRESS
KS 6 PACK
3441/3442



NEW
PHOTON EXPRESS KS
3448/2879



NEW
PHOTON EXPRESS KS
6 PACK
2881/2881



NEW
PHOTON MIXED
EXPRESS KS
3450/2887



NEW
PHOTON MIXED
EXPRESS KS 6 PACK
3451/2889



NEW
PHOTON WIRE
EXPRESS KS DYNEEMA®
3452/2883



NEW
PHOTON WIRE EXPRESS
KS DYNEEMA® 6 PACK
3453/2885



NEW
LOCKER DRAW KS
3436



NEW
ALPINE EXPRESS
DYNEEMA®
2891



NEW
ALPINE EXPRESS
DYNEEMA® 4 PACK
2892



NEW
NANO 22
EXPRESS KS
3435/2890



NEW
MACH EXPRESS
DYNEEMA®
2482



NEW
MACH EXPRESS
DYNEEMA® 4 PACK
2677



NEW
ORBIT EXPRESS KS
3454/3455/2894U/3363U



NEW
ORBIT EXPRESS KS
6 PACK
3458/3437/3459/3438



NEW
ORBIT MIXED
EXPRESS KS
3456/2900U



NEW
ORBIT MIXED
EXPRESS KS 6 PACK
3461/3439



NEW
ORBIT WIRE
EXPRESS KS
3457/2897U



NEW
ORBIT WIRE
EXPRESS KS 6 PACK
3460/3440



NEW
CABLE EXPRESS
2721/2722/2723/2724



NEW
GYM SAFE
CABLE EXPRESS
2725/2726/2727/2728



NEW
GYM SAFE
EXPRESS
3462/3209



NEW
GYM SAFE
EXPRESS PLUS
3463/311918



NEW
GYM SAFE
EXPRESS PROTECTOR
3118

Technical features on LOCKER DRAW KS quickdraw

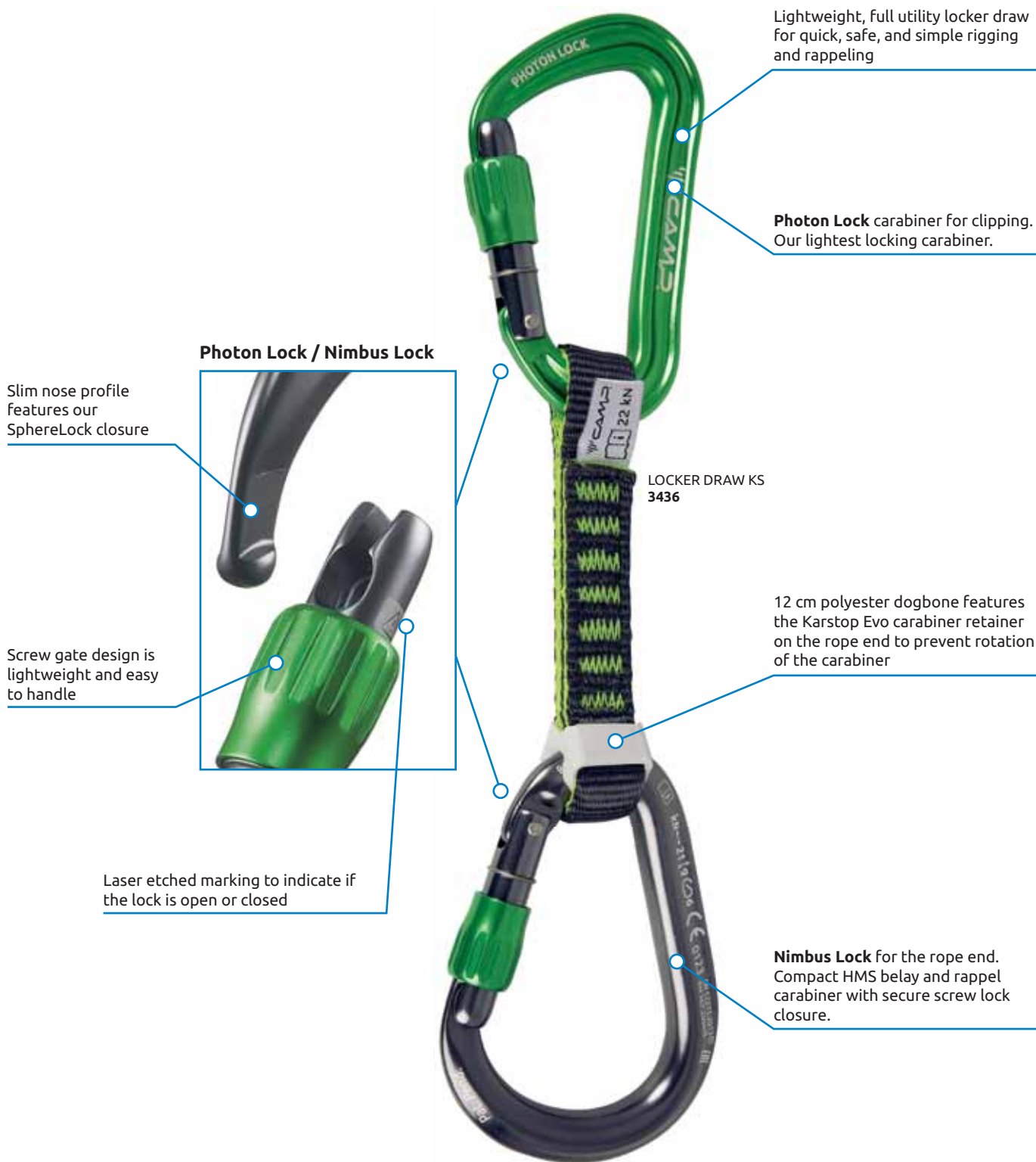



246001
(Light Blue)

246002
(Yellow)

246003
(Gun Metal)



246004
(Titanium)

246005
(Purple)

246006
(Green)



246007
(Red)

246008
(Orange)

DYON

2460

1ST CLASS

PAT. PEND.

ALPINISM, ROCK CLIMBING

- Innovative KeyWire design combines the benefits of wire gate action with a keylocking closure
- SphereLock closure minimizes play between the gate and nose for enhanced safety and performance
- Curved I-Beam construction on the spine creates a very high open gate strength
- 8 colors coordinate with the most popular cam colors

Another step forward in carabiner evolution, the Dyon uses a two-part gate to combine the benefits of smooth wire gate action with a keylocking closure. This unique combination gives it both high levels of performance and safety. The curved I-Beam construction on the spine keeps the weight to a minimum while providing a high level of rigidity and an incredible open gate strength of 11 kN. The SphereLock closure minimizes play between the gate and nose for enhanced safety and performance. Available in 8 colors to coordinate with the most popular cam colors.







DYON RACK PACK

2651 6 pcs

PAT. PEND.

- 6 colors coordinate with the most popular cam colors



Ref.	Product name	Weight								Material	CE	
		g	oz	kN	kN	kN	mm	mm	mm		EN 12275	EN 362
2460	DYON	33	1.2	21	7	11	26	100	60	Aluminum alloy	B	



233509 (Titanium) 233510 (Gun Metal) 233511 (Light Blue)



233512 (Purple) 233513 (Green) 233514 (Red)



233515 (Yellow) 233516 (Orange)



NANO 22

2335

LIGHT&FAST

ALPINISM, ROCK CLIMBING

- One of the lightest carabiners on the market
- Designed for fluid use with ropes of all diameters
- Significantly reduces weight and bulk on any rack
- Optimised design increases strength and reduces weight
- Available in 8 colors with a bright finish to coordinate with the most popular cam colors

The evolution of the Nano continues. Following the popular Nano Wire and Nano 23, the Nano 22 is even lighter, stronger, and more functional. The Nano 22 features a special design that is 1 kN stronger in all three of the strength ratings, a deeper basket for holding the rope in its proper position, and a refined gate for smooth, easy clipping. At 22 grams, the Nano 22 is the lightest fully-functional carabiner on the market with unique attributes that set it apart from other smaller carabiners. Like an inner working space large enough to use a clove hitch with ropes of any diameter, a gate opening wide enough for easy clipping on the sharp end, a profiled nose that slips in and out of tight chain links, and 8 colors for individually racking cams. As the trend towards lighter and faster, bigger and bolder continues, the Nano continues to set the standard for carabiners in the area of lightweight functionality.

NANO 22 RACK PACK

2479 6 pcs

- 6 colors coordinate with the most popular cam colors



Ref.	Product name	Weight		↺ ^{kN}	↻ ^{kN}	↻	↻ ^{mm}	↻ ^{mm}	↻ ^{mm}	Material	CE	
		g	oz	kN	kN	kN	mm	mm	mm		EN 12275	EN 362
2335	NANO 22	22	0.8	21	8	9	17	86	52	Aluminum alloy	B	



PHOTON STRAIGHT GATE

246701

PAT. PEND.

ROCK CLIMBING

- The lightest solid gate carabiner in the world
- Slim nose profile features our SphereLock closure
- Optimized body design increases rigidity and strength without increasing weight

The lightest solid gate carabiner on the market. The SphereLock closure is an upgrade to the traditional keylock system with an even cleaner nose profile.



PHOTON BENT GATE

2468

PAT. PEND.

ROCK CLIMBING

- The lightest solid gate carabiner in the world
- Slim nose profile features our SphereLock closure
- Optimized body design increases rigidity and strength without increasing weight

Bent gate version of the Photon designed for the rope end on quickdraws. The Photon is the lightest solid gate carabiner on the market. The SphereLock closure is an upgrade to the traditional keylock system with an even cleaner nose profile.

PHOTON LOCK

293101 Blue

293103 Gun metal

293104 Green

UPDATED

NEW

LIGHT&FAST

1ST CLASS

PAT. PEND.

ALPINISM, ROCK CLIMBING

- Our lightest locking carabiner
- New screw gate is lightweight and easy to handle
- Slim nose profile features our SphereLock closure
- Laser etched marking to indicate if the lock is open or closed
- Available in 3 colors

The Photon Lock is the anchor carabiner of choice for alpinists and multi-pitch climbers. Its full-size design gives it great versatility for any kind of climbing. I-Beam construction delivers a high strength-to-weight ratio while still maintaining a rope friendly radius. The SphereLock nose makes clipping ropes, webbing, chains and pro easy.



293101

293103

293104



PHOTON LOCK 3 PACK

3433

NEW

PAT. PEND.

Ref.	Product name	Weight		kN	kN	kN	mm	mm	mm	Material	CE	
		g	oz								EN 12275	EN 362
246701	PHOTON STRAIGHT GATE	36	1.3	22	7	9	21	100	60	Aluminum alloy	B	
2468	PHOTON BENT GATE	36	1.3	22	7	9	25	100	60	Aluminum alloy	B	
2931	PHOTON LOCK	43	1.5	23	8	9	17	102	63	Aluminum alloy	B	



247001
(Light Blue)

247002
(Yellow)

247003
(Gun Metal)



247004
(Titanium)

247005
(Purple)

247006
(Green)



247007
(Red)

247008
(Orange)

PHOTON WIRE

2470

LIGHT&FAST

ALPINISM, ROCK CLIMBING

- Still the lightest full-size carabiner in the world
- Optimized body design increases rigidity and strength without increasing weight
- Redesigned interface between the gate and nose helps to protect the wire gate from damage and accidental opening
- 8 colors coordinate with the most popular cam colors

The Photon Wire remains one of the lightest carabiners in the world and is still significantly larger than other carabiners in its class. The newest generation features an updated body design that increases strength and rigidity to handle the odd stresses that climbers put on their gear. We have also redesigned the interface between the gate and nose to help protect the wire gate from damage or accidental opening. Available in eight colors for individually racking cams – team the sling color with the coordinating carabiner color for the fastest way to identify the right cam size on the sharp end and reorganize the rack at belays. The Photon Wire is perfect for climbers who want a racking carabiner that is lightweight and low-profile but still clips with the ease of a high-end quickdraw. It is particularly well-suited for difficult trad leads or alpine mixed routes and ice climbing where a full-size carabiner is much easier to operate while wearing gloves.

PHOTON WIRE RACK PACK

2469 6 pcs

- 6 colors coordinate with the most popular cam colors



Ref.	Product name	Weight		kN	↻ kN	↻	mm	mm	mm	Material	CE	
		g	oz								kN	kN
2470	PHOTON WIRE	30	1.1	22	8	9	26	100	62	Aluminum alloy	B	



ORBIT STRAIGHT GATE

248303

PAT. PEND.

ROCK CLIMBING

- Optimized design increases strength without increasing weight
- Slim nose profile features our SphereLock closure

The Orbit is a solid workhorse for everyday climbing with great durability, smooth clipping action and our SphereLock closure for a super slim nose profile.



ORBIT BENT GATE

248403

PAT. PEND.

ROCK CLIMBING

- Optimized design increases strength without increasing weight
- Slim nose profile features our SphereLock closure

Bent gate version of the Orbit designed for the rope end on quickdraws. The Orbit is a solid workhorse for everyday climbing with great durability, smooth clipping action and our SphereLock closure for a super slim nose profile.









ORBIT WIRE

248507

ALPINISM, ROCK CLIMBING

- Optimized profile reduces weight
- Interface between the gate and nose helps to protect the wire gate from damage and accidental openings

Smooth gate action and a truly functional size make the Orbit Wire a solid workhorse for any kind of climbing. The interface between the gate and nose helps to protect the wire gate from damage and accidental openings.

Ref.	Product name	Weight								Material	CE	
		g	oz								kN	kN
248303	ORBIT STRAIGHT GATE	42	1.5	24	7	8	20	98	58	Aluminum alloy	B	
248403	ORBIT BENT GATE	42	1.5	24	7	8	25	98	58	Aluminum alloy	B	
248507	ORBIT WIRE	36	1.3	22	7	8	27	98	61	Aluminum alloy	B	



293001



293002



ORBIT LOCK

292901 Orange
292902 Gun metal

BEST SELLER PAT. PEND.

ALPINISM, ROCK CLIMBING, RIGGING

- A lightweight and compact locking carabiner for anchors and rigging
- New screw gate is lightweight and easy to handle
- Optimized design increases strength without increasing weight
- Slim nose profile features our SphereLock closure
- Laser etched marking to indicate if the lock is open or closed
- Available in 2 colors

The body design of the Orbit Lock adds strength and rigidity while maintaining a truly utilitarian size for everything from anchors to rigging to attaching auto-blocking belay devices where a compact D tends to fit better than larger HMS style carabiners. The SphereLock nose makes clipping ropes, webbing, chains and pro easy.

ORBIT LOCK 3 PACK

293001 Orange
293002 Gun metal

PAT. PEND.

Ref.	Product name	Weight		kN	kN	kN	mm	mm	mm	Material	CE	
		g	oz								EN 12275	EN 362
2929	ORBIT LOCK	45	1.6	24	8	8	17	98	58	Aluminum alloy	B	B



292101
(Blue)

292102
(Green)



292103
(Gun metal)

292104
(Black)

ATOM LOCK

2921

BEST SELLER PAT. PEND.

ALPINISM, ROCK CLIMBING, RIGGING, RESCUE

- High-strength HMS carabiner with a secure screw lock closure
- New screw gate is lightweight and easy to handle
- SphereLock nose make clipping ropes and webbing easy
- Laser etched marking to indicate if the lock is open or closed
- Available in 4 colors

The Atom Lock is a high-strength HMS carabiner designed for belaying and rappelling. The SphereLock nose combines with a large gate opening to make clipping ropes and webbing easy.



Video



Video



ATOM BELAY LOCK

2924

PAT. PEND.

ROCK CLIMBING, ALPINISM, RIGGING

- High-strength HMS carabiner with a secure screw lock closure and an inner gate to prevent cross-loading
- New screw gate is lightweight and easy to handle
- SphereLock nose make clipping ropes and webbing easy
- Laser etched marking to indicate if the lock is open or closed

The Atom Belay Lock is a high-strength HMS carabiner designed for belaying and rappelling. The inner gate creates a captive eye to prevent rotations that can lead to cross-loading and the SphereLock nose combines with a large gate opening to make clipping ropes and webbing easy.

Ref.	Product name	Weight		kN	kN	kN	mm	mm	mm	Material	CE	
		g	oz								EN 12275	EN 362
2921	ATOM LOCK	82	2.9	26	11	8	24	120	78	Aluminum alloy	H	B
2924	ATOM BELAY LOCK	85	3.0	24	11	8	24	120	78	Aluminum alloy	H	B



Video

ATOM 2LOCK

2922

PAT. PEND.

ALPINISM, ROCK CLIMBING, RIGGING, RESCUE

- High-strength HMS carabiner with automatic lock that requires two actions (twist and pull) to open
- Double-action twist lock sleeve is easy to engage with one hand
- Large gate opening and SphereLock nose make clipping ropes and webbing easy

The Atom 2Lock is a high-strength HMS carabiner designed for belaying and rappelling. The SphereLock nose combines with a large gate opening to make clipping ropes and webbing easy. The automatic lock requires two actions (twist and pull) to open.



Video

ATOM 3LOCK

2923

PAT. PEND.

ALPINISM, ROCK CLIMBING, RIGGING, RESCUE

- High-strength HMS carabiner with automatic lock that requires three actions (slide, twist, and pull) to open
- Triple-action makes it safer than standard auto-locking carabiners
- Large gate opening and SphereLock nose make clipping ropes and webbing easy

The Atom 3Lock is a high-strength HMS carabiner designed for belaying and rappelling. The SphereLock nose combines with a large gate opening to make clipping ropes and webbing easy. The automatic lock requires three actions (slide, twist, pull) to open.



NITRO LOCK

2928

LIGHT&FAST

1ST CLASS

PAT. PEND.

ALPINISM, ROCK CLIMBING

- Our lightest HMS locking carabiner
- New screw gate is lightweight and easy to handle
- Sophisticated shape creates a high strength-to-weight ratio
- SphereLock nose makes clipping ropes and webbing easy
- Laser etched marking to indicate if the lock is open or closed

One of the lightest HMS locking carabiners in the world. The Nitro Lock has been optimized to maximize both safety and performance. I-Beam construction delivers a high strength-to-weight ratio while still maintaining a rope friendly radius. The SphereLock nose makes clipping ropes and webbing easy.

Ref.	Product name	Weight		Strength			Dimensions			Material	CE	
		g	oz	kN	kN	kN	mm	mm	mm		EN 12275	EN 362
2922	ATOM 2LOCK	88	3.1	26	11	8	24	120	78	Aluminum alloy	H	B
2923	ATOM 3LOCK	88	3.1	26	11	8	24	120	78	Aluminum alloy	H	B
2928	NITRO LOCK	56	2.0	22	9	6	24	106	75	Aluminum alloy	H	



CORE LOCK

2925

PAT. PEND.

ALPINISM, ROCK CLIMBING, RIGGING, RESCUE

- Extremely smooth HMS belay and rappel carabiner with secure screw lock closure
- New screw gate is lightweight and easy to handle
- Large gate opening and SphereLock nose make clipping ropes and webbing easy
- Laser etched marking to indicate if the lock is open or closed

The unique shape of the Core Lock HMS carabiner creates a very wide gate opening and positions ropes for the smoothest belays and rappels. The SphereLock nose makes clipping ropes and webbing easy.



CORE BELAY LOCK

2926

PAT. PEND.

ROCK CLIMBING, ALPINISM, RIGGING

- Extremely smooth HMS belay and rappel carabiner with secure screw lock closure
- New screw gate is lightweight and easy to handle
- Inner gate prevents cross-loading
- Large gate opening and SphereLock nose make clipping ropes and webbing easy
- Laser etched marking to indicate if the lock is open or closed

The unique shape of the Core Lock HMS carabiner creates a very wide gate opening and positions ropes for the smoothest belays and rappels. The inner gate creates a captive eye to prevent rotations that can lead to cross-loading and the SphereLock nose makes clipping ropes and webbing easy.



NEW

NIMBUS LOCK

2927 Gun metal / Green

292702 Gun metal / Fuchsia

292703 Gun metal / Blue

PAT. PEND.

ALPINISM, ROCK CLIMBING, RIGGING

- Compact HMS belay and rappel carabiner with secure screw lock closure
- Screw gate design is lightweight and easy to handle
- SphereLock nose makes clipping ropes and webbing easy
- Laser etched marking to indicate if the lock is open or closed
- Available in 3 colors

The Nimbus Lock has all the benefits of a full-utility HMS locking carabiner in a compact size. The unique shape ideally positions ropes for smooth belays and rappels and the SphereLock nose makes clipping ropes and webbing easy.



NIMBUS LOCK 3 PACK

3434

NEW

PAT. PEND.

Ref.	Product name	Weight		kN	kN	kN	mm	mm	mm	Material	CE	
		g	oz								EN 12275	EN 362
2925	CORE LOCK	81	2.9	23	11	6	25	114	77	Aluminum alloy	H	B
2926	CORE BELAY LOCK	84	3.0	22	11	6	25	114	77	Aluminum alloy	H	B
2927	NIMBUS LOCK	69	2.4	21	9	6	22	101	71	Aluminum alloy	H	B



ATLAS LOCK

137304

ROCK CLIMBING, RIGGING, RESCUE

- Amazingly strong aluminum carabiner
- Screwgate with key lock closure

The Atlas is notable for its superior strength—which approaches the strength of some steel carabiners, but at a fraction of the weight—and its oversized design which makes rigging easy, even while wearing gloves. This combination of strength and ease of use makes it an ideal carabiner for search and rescue applications.



ATLAS 2LOCK

137404

ROCK CLIMBING, RIGGING, RESCUE

- Amazingly strong aluminum carabiner
- Automatic lock requires two actions (twist and pull) to open
- Easy to operate with one hand
- Large gate opening and keylock nose make clipping ropes and webbing easy

The Atlas carabiner with an automatic twist lock closure. The Atlas is notable for its superior strength—which approaches the strength of some steel carabiners, but at a fraction of the weight—and its oversized design which makes rigging easy, even while wearing gloves. This combination of strength and ease of use makes it an ideal carabiner for search and rescue applications.









ATLAS 3LOCK

137504

ROCK CLIMBING, RIGGING, RESCUE

- Amazingly strong aluminum carabiner
- Automatic lock requires three actions (slide, twist, and pull) to open
- Easy to operate with one hand
- Large gate opening and keylock nose make clipping ropes and webbing easy

The Atlas carabiner with an automatic triple-action twist lock closure for maximum security. The new Atlas is notable for its superior strength—which approaches the strength of some steel carabiners, but at a fraction of the weight—and its oversized design which makes rigging easy, even while wearing gloves. This combination of strength and ease of use makes it an ideal carabiner for search and rescue applications. We recommend the 3Lock system if you intend to use an auto-locker as your general belay carabiner.

Ref.	Product name	Weight		 kN	 kN	 kN	 mm	 mm	 mm	Material	CE	
		g	oz								kN	kN
137304	ATLAS LOCK	87	3.1	40	10	13	22	120	68	Aluminum alloy	B	B
137404	ATLAS 2LOCK	92	3.2	40	10	13	22	120	68	Aluminum alloy	B	B
137504	ATLAS 3LOCK	92	3.2	40	10	13	22	120	68	Aluminum alloy	B	B



GUIDE LOCK

130903

ALPINISM, ROCK CLIMBING, RIGGING

- Very strong and durable carabiner for heavy use
- Keylock nose for clipping into anchors

Smooth operating, super strong D screw gate carabiner with a keylock closure to reduce snagging. A great choice for serious mileage.



GUIDE XL LOCK

136303

ALPINISM, ROCK CLIMBING, RIGGING, RESCUE

- Very strong and durable carabiner for heavy use
- Large gate opening and keylock nose make clipping ropes and webbing easy
- Screwgate with key lock closure

An oversized version of our popular Guide carabiner with a unique shape that gives it an excellent strength-to-weight ratio and a huge gate opening for easy handling with ropes and rigging. An excellent choice for anchors and rigging.



GUIDE XL 2LOCK

136403

ALPINISM, ROCK CLIMBING, RIGGING, RESCUE

- Automatic lock requires two actions (twist and pull) to open
- Easy to operate with one hand
- Large gate opening and keylock nose make clipping ropes and webbing easy

The Guide XL carabiner with an automatic twist lock closure. The Guide XL is an oversized version of our popular Guide carabiner with a unique shape that gives it an excellent strength-to-weight ratio and a huge gate opening for easy handling with ropes and rigging. An excellent choice for anchors and rigging.



GUIDE XL 3LOCK

136503

ALPINISM, ROCK CLIMBING, RIGGING, RESCUE

- Automatic lock requires three actions (slide, twist, and pull) to open
- Easy to operate with one hand
- Large gate opening and keylock nose make clipping ropes and webbing easy

The Guide XL carabiner with an automatic triple-action twist lock closure for maximum security. The Guide XL is an oversized version of our popular Guide carabiner with a unique shape that gives it an excellent strength-to-weight ratio and a huge gate opening for easy handling with ropes and rigging. We recommend the 3Lock system if you intend to use an auto-locker as your general belay carabiner.

Ref.	Product name	Weight		kN	↺ kN	↻	↻ ^{mm}	mm	mm	Material	CE	
		g	oz	kN	kN	kN	mm	mm	mm		EN 12275	EN 362
130903	GUIDE LOCK	77	2.7	32	10	10	18	112	63	Aluminum alloy	B	B
136303	GUIDE XL LOCK	82	2.9	28	9	8	23	117	75	Aluminum alloy	B	B
136403	GUIDE XL 2LOCK	86	3.0	28	9	8	24	117	75	Aluminum alloy	B	B
136503	GUIDE XL 3LOCK	86	3.0	28	9	8	24	117	75	Aluminum alloy	B	B



OVAL XL

2126

ROCK CLIMBING, CAVING

- Super-strong, full-size oval carabiner
- Large gate opening
- Keylock nose

The Oval XL is a full-size oval carabiner with an exceptional strength-to-weight ratio. I-Beam construction gives it a sleek profile for easy handling and the large gate opening combines with a Keylock nose for maximum ease of use with ropes and hardware. These features also make it a great option for racking wires and pins.



OVAL XL LOCK

2123

ALPINISM, ROCK CLIMBING, CAVING, RIGGING, RESCUE

- Super-strong, full-size oval carabiner with locking screw gate
- Large gate opening
- Keylock nose
- Ideal for use with pulleys and ascender-descender devices

The Oval XL Lock is an exceptionally strong full-size locking oval carabiner. With its sophisticated I-Beam construction, it is also surprisingly lightweight. Its large gate opening, keylock nose and locking screw gate make it ideal for use with pulleys and ascender-descender devices.



OVAL XL 2LOCK

2124

ALPINISM, ROCK CLIMBING, CAVING, RIGGING, RESCUE

- Super-strong, full-size oval carabiner with automatic lock that requires two actions (twist and pull) to open
- Large gate opening
- Keylock nose
- Ideal for use with pulleys and ascender-descender devices

The Oval XL 2Lock is a super-strong, full-size auto-locking oval carabiner. With its sophisticated I-Beam construction, it is also surprisingly lightweight. Its large gate opening, keylock nose and dual-action twist lock closure make it ideal for use with pulleys and ascender-descender devices.



OVAL XL 3LOCK

2125

ALPINISM, ROCK CLIMBING, CAVING, RIGGING, RESCUE

- Super-strong, full-size oval carabiner with automatic lock that requires three actions (slide, twist and pull) to open
- Large gate opening
- Keylock nose
- Ideal for use with pulleys and ascender-descender devices

The Oval XL 3Lock is a super-strong, full-size oval carabiner with our secure 3Lock auto-locking closure that requires three actions (slide, twist and pull) to open. With its sophisticated I-Beam construction, the Oval XL 3Lock is notably stronger and lighter than other carabiners in its class.

Ref.	Product name	Weight		kN	kN	kN	mm	mm	mm	Material	CE	
		g	oz								EN 12275	EN 362
2126	OVAL XL	66	2.3	28	11	7	22	110	62	Aluminum alloy	B	
2123	OVAL XL LOCK	71	2.5	28	11	7	19	110	62	Aluminum alloy	B	B
2124	OVAL XL 2LOCK	76	2.7	28	11	7	19	110	62	Aluminum alloy	B	B
2125	OVAL XL 3LOCK	77	2.7	28	11	7	19	110	62	Aluminum alloy	B	B



OVAL COMPACT LOCK

1115

ALPINISM, ROCK CLIMBING, CAVING

- One of the strongest oval carabiners on the market

A compact style of oval carabiner with an exceptional strength to weight ratio. Features a keylock screw gate closure. Locking oval carabiners are ideal for work with pulleys, caving, and big walls and aid climbing.

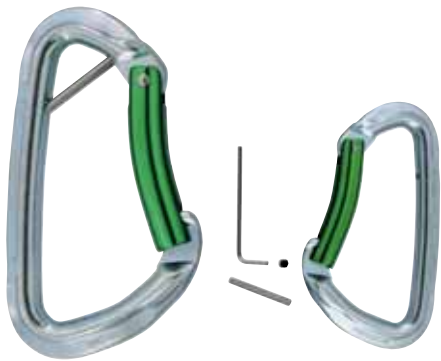

GYM SAFE

127001

CLIMBING GYMS

- Large opening and keylock nose for easy clipping
- Steel body for durability, aluminum gate for smooth clipping
- Zinc plating helps prevent rust in humid environments
- Special keeper pin ensures proper orientation and prevents theft

A steel body carabiner specifically designed for use in gyms and outside on high traffic routes and anchors. The smooth action and wide opening of the aluminum alloy bent gate combine with the keylock closure to make clipping and cleaning a breeze. A special keeper pin held in place by a bolt locks the carabiner on draws to help ensure proper orientation and prevent theft (hex wrench included).



HERCULES

0995

VIA FERRATA, RIGGING, RESCUE

- Automatic lock opens by squeezing the carabiner and pulling the gate
- Large opening and keylock nose for clipping anchors and cables
- Release lever on back is constructed from stainless steel

The Hercules features the safest and most user-friendly locking mechanism for via ferrata (especially easy to operate with gloves). The gate opens by squeezing the back lever and gate together and auto locks when released. The keylock nose helps prevent snagging.

Ref.	Product name	Weight		kN	↕ kN	↻ kN	↻ mm	mm	mm	Material	CE		121
		g	oz	kN	kN	kN	mm	mm	mm		EN 12275	EN 362	
1115	OVAL COMPACT LOCK	71	2.5	24	10	7	15	106	57	Aluminum alloy	X	B	
127001	GYM SAFE	110	3.9	24	8	13	24	99	58	Carbon steel	B		
0995	HERCULES	125	4.4	30	9	16	23	140	71	Aluminum alloy	K	T	•



NOMAD
240701

VIA FERRATA, ROPE COURSES & INSTITUTIONAL

- Automatic lock requires sliding the sleeve down and pulling the gate to open
- Easy to engage with one hand
- Keylock nose for easy clipping to anchors and cables
- Ergonomic body design facilitates clipping and unclipping

A full-size via ferrata carabiner with a keylock closure and auto-locking gate that is easy to operate with one hand (just slide and pull).



TRIAD LOCK
3141

CAVING, ROPE COURSES & INSTITUTIONAL, RIGGING, RESCUE

- Semicircular aluminum carabiner with a breaking load of 16 kN in all directions
- Loaded on three points it has a breaking load of 25 kN
- Keylock closure with locking screw gate

Semicircular aluminum carabiner designed to guarantee a breaking load of 16 kN in all directions. If loaded on three points, the Triad Lock has a breaking load of 25 kN so it is ideal for connecting a chest harness with front slots to a waist harness.









TRIAD 3LOCK
3142

CAVING, ROPE COURSES & INSTITUTIONAL, RIGGING, RESCUE

- Semicircular aluminum carabiner with a breaking load of 16 kN in all directions
- Loaded on three points it has a breaking load of 25 kN
- Automatic closure requires three actions (slide, rotate and press) to open the carabiner

Semicircular aluminum carabiner designed to guarantee a breaking load of 16 kN in all directions. If loaded on three points, the Triad 3Lock has a breaking load of 25 kN so it is ideal for connecting a chest harness with front slots to a waist harness. Auto-locking closure for extra security and ease of use.

Ref.	Product name	Weight								Material	CE	
		g	oz	kN	kN	kN	mm	mm	mm		EN 12275	EN 362
240701	NOMAD	88	3.1	25	8	9	29	131	76	Aluminum alloy	K	
3141	TRIAD LOCK	84	3.0	20	16	8	16	103	73	Aluminum alloy	B	M
3142	TRIAD 3LOCK	88	3.1	20	16	8	16	103	73	Aluminum alloy	B	M



OVAL STANDARD LOCK

0981

INDUSTRIAL

- Especially useful with pulleys in rescue work
- Zinc plating helps prevent rust in humid environments

Steel oval carabiner with a locking screw gate. 28 kN.



OVAL PRO LOCK

1455

INDUSTRIAL, RIGGING, RESCUE

- Especially useful with pulleys in rescue work
- Zinc plating helps prevent rust in humid environments
- Keylock nose reduces snagging

Locking steel oval carabiner with a tremendous minor axis strength and a keylock nose to reduce snagging.



OVAL PRO 2LOCK

1878

INDUSTRIAL, RIGGING, RESCUE

- Automatic lock requires two actions (twist and pull) to open
- Zinc plating helps prevent rust in humid environments

Auto-locking steel oval carabiner with a tremendous minor axis strength. The 2Lock is easy to operate with one hand and the keylock nose reduces snagging on ropes and chains.









OVAL PRO 3LOCK

1456

INDUSTRIAL, RIGGING, RESCUE

- Automatic lock requires three actions (slide, twist and pull) to open
- Zinc plating helps prevent rust in humid environments
- Keylock nose

Auto-locking steel oval carabiner with a tremendous minor axis strength. Features a triple-action auto-locking gate that can be operated with one hand and a keylock nose to reduce snagging.

Ref.	Product name	Weight								Material	CE	
		g	oz	kN	kN	kN	mm	mm	mm		EN 12275	EN 362
0981	OVAL STANDARD LOCK	165	5.8	28	7	10	16	108	58	Carbon steel		B
1455	OVAL PRO LOCK	180	6.4	30	15	9	17	109	56	Carbon steel	B	B
1878	OVAL PRO 2LOCK	200	7.1	30	15	9	17	109	56	Carbon steel	B	B
1456	OVAL PRO 3LOCK	210	7.4	30	15	9	17	109	56	Carbon steel	B	B



D PRO LOCK

1877

INDUSTRIAL, RIGGING, RESCUE

- Very high strength and durability (52 kN)
- Zinc plating helps prevent rust in humid environments

Super strong steel D-shaped carabiner features a very large gate opening, locking screw gate and a keylock nose to reduce snagging.



D PRO 2LOCK

187701

INDUSTRIAL, RIGGING, RESCUE

- Automatic lock requires two actions (twist and pull) to open
- Zinc plating helps prevent rust in humid environments

Super strong steel D-shaped carabiner features an auto-locking gate that is easy to operate with one hand and a keylock nose to reduce snagging.









D PRO 3LOCK

187702

INDUSTRIAL, RIGGING, RESCUE

- Automatic lock requires three actions (slide, twist and pull) to open
- Zinc plating helps prevent rust in humid environments

Super strong steel D-shaped carabiner features a triple-action auto-locking gate that can be operated with one hand and a keylock nose to reduce snagging.

Ref.	Product name	Weight								Material	CE	
		g	oz	kN	kN	kN	mm	mm	mm		EN 12275	EN 362
1877	D PRO LOCK	250	8.8	50	15	18	24	114	72	Carbon steel	B	B
187701	D PRO 2LOCK	270	9.5	50	15	18	24	114	72	Carbon steel	B	B
187702	D PRO 3LOCK	280	9.9	50	15	18	24	114	72	Carbon steel	B	B



OVAL QUICK LINK STAINLESS

0939 8 mm

0949 10 mm

INDUSTRIAL, RIGGING

CE certified stainless steel oval quick links for industrial rigging and anchors. The 8 mm requires a 14 mm open-end wrench. The 10 mm requires a 17 mm open-end wrench.



OVAL MINI LINK STAINLESS

0929 5 mm

INDUSTRIAL

A hyperlight and compact quick link for rigging and rappels. The stainless steel body is harder than traditional Carbon steel so it will hold up to wear and tear from ropes better over time. Not CE certified.



OVAL QUICK LINK STEEL

0934 8 mm







093401 8 mm - 5 pz

0935 10 mm

093501 10 mm - 5 pz

INDUSTRIAL, RIGGING

CE certified steel oval quick links for industrial rigging and anchors. Zinc plating helps prevent rust in humid environments. The 8 mm requires a 14 mm open-end wrench. The 10 mm requires a 17 mm open-end wrench.

Ref.	Product name	Weight		 kN	 kN	 kN	 mm	 mm	 mm	Material	CE	
		g	oz								kN	kN
0939	OVAL QUICK LINK STAINLESS 8 mm	76	2.7	50	10		9	74	39	Stainless steel	Q	Q
0949	OVAL QUICK LINK STAINLESS 10 mm	145	5.1	50	10		12	89	47	Stainless steel	Q	Q
0929	OVAL MINI LINK STAINLESS 5 mm	21	0.7	25			6	50	25	Stainless steel		
0934	OVAL QUICK LINK STEEL 8 mm	81	2.9	40	10		9	74	39	Carbon steel	Q	Q
0935	OVAL QUICK LINK STEEL 10 mm	143	5.0	45	10		12	89	47	Carbon steel	Q	Q



DELTA QUICK LINK STAINLESS

0991 8 mm
0992 10 mm

INDUSTRIAL, RIGGING

CE certified stainless steel triangular quick links for use in anchors and work and industrial. The 8 mm requires a 14 mm open-end wrench. The 10 mm requires a 17 mm open-end wrench.



DELTA QUICK LINK STEEL

0955 8 mm
0961 10 mm

INDUSTRIAL, RIGGING

CE certified steel triangular quick links for use in anchors and work and industrial. Zinc plating helps prevent rust in humid environments. The 8 mm requires a 14 mm open-end wrench. The 10 mm requires a 17 mm open-end wrench.



D QUICK LINK STEEL

0691 10 mm

INDUSTRIAL, RIGGING

CE and UIAA certified 10 mm steel D-shaped quick link for use in rigging and industrial work. Requires a 17 mm open-end wrench.



D QUICK LINK ALU

0671 12 mm

INDUSTRIAL, RIGGING

CE certified 12 mm aluminum D-shaped quick link for use in rigging and industrial work. Requires a 17 mm open-end wrench.

Ref.	Product name	Weight								Material	CE	
		g	oz								kN	kN
0991	DELTA QUICK LINK STAINLESS 8 mm	85	3.0	35	10		10	73	56	Stainless steel	Q	Q
0992	DELTA QUICK LINK STAINLESS 10 mm	156	5.5	45	10		12	87	69	Stainless steel	Q	Q
0955	DELTA QUICK LINK STEEL 8 mm	88	3.1	30	10		10	73	56	Carbon steel	Q	Q
0961	DELTA QUICK LINK STEEL 10 mm	164	5.8	40	10		12	87	69	Carbon steel	Q	Q
0691	D QUICK LINK STEEL 10 mm	157	5.5	48	13		12	86	69	Carbon steel	Q	Q
0671	D QUICK LINK ALU 12 mm	125	4.4	25	16		14	107	85	Aluminum alloy	Q	Q



DYON EXPRESS KS

NEW
3445 12 cm - 85 g
2466 18 cm - 91 g

1ST CLASS PAT. PEND.

ROCK CLIMBING

- A premium quickdraw for all-around climbing
- Equipped with two Dyon KeyWire carabiners
- The Dyon features our KeyWire design that combines the benefits of wire gate action with the SphereLock closure
- Curved I-Beam construction on the spine creates a very high open gate strength
- Variable width polyester dogbones are easy to grab while projecting sport routes
- Features the Karstop Evo carabiner retainer on the rope end
- Available in 12 and 18 cm lengths

The Dyon Express KS is a benchmark draw that incorporates our high-end Dyon carabiners for super smooth clipping and cleaning. The Dyon uses a two-part gate to combine the benefits of smooth wire gate action with a keylocking closure. This unique combination gives it high levels of both performance and safety. The curved I-Beam construction on the spine keeps the weight to a minimum while providing a high level of rigidity and an incredible open gate strength of 11 kN. The SphereLock closure is an upgrade to the traditional keylock system with an even cleaner nose profile. The Dyon Express KS also uses our most sophisticated dogbone with variable width webbing that makes them easy to grab while projecting sport routes and the Karstop Evo carabiner retainer on the rope end. Available in 12 and 18 cm lengths.



DYON EXPRESS KS 6 PACK

NEW
3446 12 cm
2875 18 cm

PAT. PEND.

Ref.	Product name	Weight		Product name	kN	kN	kN	mm	mm	mm	kN	CE	
		g	oz									EN 12275	EN 566
3445	DYON EXPRESS KS 12 cm	85	3.0	DYON - Gun metal	21	7	11	26	100	60	22	B	•
				DYON - Yellow	21	7	11	26	100	60			
2466	DYON EXPRESS KS 18 cm	91	3.2	DYON - Gun metal	21	7	11	26	100	60	22	B	•
				DYON - Yellow	21	7	11	26	100	60			



DYON MIXED EXPRESS KS

NEW 3447 12 cm - 88 g
2877 18 cm - 94 g

PAT. PEND.

ALPINISM, ROCK CLIMBING

- For sport climbing at the highest level
- Equipped with a Photon straight gate carabiner on the bolt end and a Dyon KeyWire carabiner on the rope end
- The Photon is our lightest solid gate carabiner featuring our SphereLock closure for easy cleaning
- The Dyon features our KeyWire design that combines the benefits of wire gate action with the SphereLock closure
- Curved I-Beam construction on the spine of the Dyon creates a very high open gate strength
- Variable width polyester dogbones are easy to grab while projecting sport routes
- Features the Karstop Evo carabiner retainer on the rope end
- Available in 12 and 18 cm lengths

Our most sophisticated quickdraw for sport climbing at the highest level. The Dyon Mixed Express KS utilizes the tried and true Photon straight gate carabiner on the bolt end and the Dyon KeyWire carabiner on the rope end. The Dyon uses a two-part gate to combine the benefits of smooth wire gate action with a keylocking closure. This unique combination gives it both high levels of performance and safety. The curved I-Beam construction on the spine keeps the weight to a minimum while providing a high level of rigidity and an incredible open gate strength of 11 kN. The SphereLock closure is an upgrade to the traditional keylock system with an even cleaner nose profile. The Dyon Mixed Express KS also uses our most sophisticated dogbone with variable width webbing that makes them easy to grab while projecting sport routes and the Karstop Evo carabiner retainer on the rope end. Available in 12 and 18 cm lengths.



DYON MIXED EXPRESS KS 6 PACK

NEW 3441 12 cm
3442 18 cm

PAT. PEND.

Ref.	Product name	Weight		Product name								CE	
		g	oz		kN	kN	kN	mm	mm	mm		EN 12275	EN 566
3447	DYON MIXED EXPRESS KS 12 cm	88	3.1	PHOTON STRAIGHT GATE	22	7	9	21	100	60	22	B	•
				DYON - Yellow	21	7	11	26	100	60			
2877	DYON MIXED EXPRESS KS 18 cm	94	3.3	PHOTON STRAIGHT GATE	22	7	9	21	100	60	22	B	•
				DYON - Yellow	21	7	11	26	100	60			

2879

3448



NEW

PHOTON EXPRESS KS

3448 12 cm - 91 g

2879 18 cm - 97 g

1ST CLASS

PAT. PEND.

ROCK CLIMBING

- A premier lightweight quickdraw for high-end sport climbing
- Equipped with a straight gate Photon carabiner on the bolt end and a bent gate Photon on the rope end
- The Photon is our lightest solid gate carabiner featuring our SphereLock closure for easy cleaning
- Variable width polyester dogbones are easy to grab while projecting sport routes
- Features the Karstop Evo carabiner retainer on the rope end
- Available in 12 and 18 cm lengths

The Photon Express KS is purpose-built for onsight climbing where every gram and every second counts. The lightweight Photon carabiners are optimized for fast action and smooth clipping. The SphereLock closure is an upgrade to the traditional keylock system with an even cleaner nose profile. The Photon Express KS also uses our most sophisticated dogbone with variable width webbing that makes them easy to grab while projecting sport routes and the Karstop Evo carabiner retainer on the rope end. Available in 12 and 18 cm lengths.

3449

2881









NEW

PHOTON EXPRESS KS 6 PACK

3449 12 cm

2881 18 cm

PAT. PEND.

Ref.	Product name	Weight		Product name								CE	
		g	oz									EN 12275	EN 566
3448	PHOTON EXPRESS KS 12 cm	91	3.2	PHOTON STRAIGHT GATE	22	7	9	21	100	60	22	B	•
				PHOTON BENT GATE	22	7	9	25	100	60			
2879	PHOTON EXPRESS KS 18 cm	97	3.4	PHOTON STRAIGHT GATE	22	7	9	21	100	60	22	B	•
				PHOTON BENT GATE	22	7	9	25	100	60			



PHOTON MIXED EXPRESS KS
NEW 3450 12 cm - 85 g
 2887 18 cm - 91 g

PAT. PEND.

ROCK CLIMBING

- A lightweight quickdraw for climbing at the highest level
- Equipped with a straight gate Photon carabiner on the bolt end and a hyperlight Photon Wire carabiner on the rope end
- The Photon is our lightest solid gate carabiner featuring our SphereLock closure for easy cleaning
- The Photon Wire delivers pure clipping bliss with its finely contoured, perfectly tensioned gate and large gate opening
- Variable width polyester dogbones are particularly easy to grab while projecting sport routes
- Features the Karstop Evo carabiner retainer on the rope end
- Available in 12 and 18 cm lengths

The Photon Mixed Express KS features a prime combination of two carabiners that have been perfectly optimized for their function. The Photon is our lightest solid gate carabiner featuring our SphereLock closure for easy clipping and cleaning. The Photon Wire delivers pure clipping bliss on the sharp end with its finely contoured, perfectly tensioned gate and large gate opening. The Photon Mixed Express KS also uses our most sophisticated dogbone with variable width webbing that makes them easy to grab while projecting sport routes and the Karstop Evo carabiner retainer on the rope end. Available in 12 and 18 cm lengths.



PHOTON MIXED EXPRESS KS 6 PACK
NEW 3451 12 cm
 2889 18 cm

PAT. PEND.



PHOTON WIRE EXPRESS KS DYNEEMA®
NEW 3452 12 cm - 69 g
 2883 18 cm - 71 g

LIGHT&FAST

ALPINISM, ROCK CLIMBING

- A lightweight quickdraw designed for big routes
- Equipped with two hyperlight, full-size Photon Wire carabiners
- 11 mm Dyneema® dogbones feature the Karstop Evo carabiner retainer on the rope end
- Available in 12 and 18 cm lengths

The Photon Wire Express KS Dyneema® is different from other lightweight quickdraws because its carabiners are still full size. In fact, the Photon Wire has a gate opening that is up to 25% bigger than other carabiners in its class. This makes clipping, cleaning and rigging easier. The 11 mm Dyneema® dogbones are equipped with the Karstop Evo carabiner retainer that prevents the rope end carabiner from shifting. Available in 12 and 18 cm lengths.



PHOTON WIRE EXPRESS KS DYNEEMA® 6 PACK
NEW 3453 12 cm
 2885 18 cm

Ref.	Product name	Weight		Product name	↻	↻	↻	↻	↻	↻	↻	CE	
		g	oz									EN 12275	EN 566
3450	PHOTON MIXED EXPRESS KS 12 cm	85	3.0	PHOTON STRAIGHT GATE	22	7	9	21	100	60	22	B	•
				PHOTON WIRE - Orange	22	8	9	26	100	62			
2887	PHOTON MIXED EXPRESS KS 18 cm	91	3.2	PHOTON STRAIGHT GATE	22	7	9	21	100	60	22	B	•
				PHOTON WIRE - Orange	22	8	9	26	100	62			
3452	PHOTON WIRE EXPRESS KS DYNEEMA 12 cm	69	2.4	PHOTON WIRE - Gun metal	22	8	9	26	100	62	22	B	•
				PHOTON WIRE - Orange	22	8	9	26	100	62			
2883	PHOTON WIRE EXPRESS KS DYNEEMA 18 cm	71	2.5	PHOTON WIRE - Gun metal	22	8	9	26	100	62	22	B	•
				PHOTON WIRE - Orange	22	8	9	26	100	62			



LOCKER DRAW KS

3436 12 cm - 129 g

NEW

PAT. PEND.

ROCK CLIMBING, ALPINISM, MULTI-PITCH CLIMBING

- Lightweight, full utility locker draw for quick, safe, and simple rigging and rappeling
- Equipped with a Photon Lock carabiner for clipping in and a Nimbus Lock for the rope end
- 12 cm polyester dogbone features the Karstop Evo carabiner retainer on the rope end

The Locker Draw combines the hyperlight Photon Lock carabiner with the Nimbus Lock HMS carabiner on the rope end for a sophisticated set up that can be used for quick, secure anchors, offset rigging points, and rappel extensions. The Photon Lock is our lightest locking carabiner and the Nimbus Lock has all of the benefits of a full-utility HMS locking carabiner in a compact size. The unique shape ideally positions ropes for smooth action and the SphereLock nose makes clipping ropes and webbing easy. The 12 cm polyester dogbone features the Karstop Evo carabiner retainer on the rope end to prevent rotation of the carabiner.

2891



ALPINE EXPRESS DYNEEMA®

2891 60 cm - 81 g

ALPINISM, MULTI-PITCH CLIMBING

- The ultimate alpine draw
- Equipped with two Photon Wire carabiners
- Versatile and lightweight 10 mm x 60 cm Dyneema® runner

The Alpine Express connects two hyperlight, full-size Photon Wire carabiners with an equally versatile and lightweight 10 mm x 60 cm Dyneema runner. The Photon Wire is the lightest full-size carabiner on the market making it the optimal choice for use in alpine environments where we are often wearing gloves. The 10 mm x 60 cm Dyneema® slings are light, strong and thin making them the perfect choice for long routes where we need the variable length, but not the extra weight or bulk. The unique properties of Dyneema® also make them particularly well-suited for wet conditions common with alpine terrain.

2892



ALPINE EXPRESS DYNEEMA® 4 PACK

2892 60 cm

Ref.	Product name	Weight		Product name	↻ kN	↻ kN	↻ kN	↻ mm	↻ mm	↻ mm	↻ kN	CE	
		g	oz									EN 12275	EN 566
3436	LOCKER DRAW KS 12 cm	129	4.6	PHOTON LOCK - Green	23	8	9	17	102	63	22	B	•
				NIMBUS LOCK - Gun metal / Green	21	9	6	22	101	71			
2891	ALPINE EXPRESS DYNEEMA 60 cm	81	2.9	PHOTON WIRE - Gun metal	22	8	9	26	100	62	22	B	•
				PHOTON WIRE - Orange	22	8	9	26	100	62			



NEW

NANO 22 EXPRESS KS

3435 12 cm - 53 g
2890 18 cm - 55 g

LIGHT&FAST

ALPINISM, MULTI-PITCH CLIMBING

- A hyperlight quickdraw for multi-pitch sport and alpine rock climbing
- Equipped with two Nano 22 carabiners
- 11 mm Dyneema® dogbone features the Karstop Evo carabiner retainer on the rope end
- Available in 12 and 18 cm lengths

A great draw for multi-pitch sport and alpine rock climbing. The compact size of the Nano 22 is particularly noticeable on gear loops where they take up less space than traditional carabiners making them easier to attach and remove on the sharp end. Yet the shape and gate opening still allow for normal clipping and the use of clove hitch knots – two great tests for determining when a carabiner is just too small. The Dyneema® dogbone is light, strong and particularly safe with the Karstop Evo carabiner retainer on the rope end that prevents the carabiner from shifting. Available in 12 and 18 cm lengths.

2482



2677



MACH EXPRESS DYNEEMA®

2482 60 cm - 73 g

ALPINISM, MULTI-PITCH CLIMBING

- The ultimate trad draw
- Equipped with the Nano 22 carabiner on the gear end and the full-size Photon Wire on the rope end
- Versatile and lightweight 10 mm x 60 cm Dyneema® runner

A good draw for long routes should be:

- Light: they are being carried a long way
- Compact: sometimes you need to carry a lot of them
- Versatile: you never know what big routes will throw at you
- Functional: easy to use in any situation

The Mach Express excels in each of these areas. The Nano 22 on the gear end situates perfectly on any kind of pro from wires to cam slings to bolt hangers and pitons. Their low profile also takes up less space on gear loops than traditional carabiners and they fish in and out of cracks, chain links and other tight spaces with ease. The Photon Wire is the lightest full-size carabiner on the market making it the optimal choice for the rope end. The 10 mm x 60 cm Dyneema® slings are light, strong and thin making them the perfect choice for long routes. The unique properties of Dyneema® also make them particularly well-suited for wet conditions common with alpine terrain.

MACH EXPRESS DYNEEMA® 4 PACK

2677 60 cm

Ref.	Product name	Weight		Product name	↻	↻	↻	↻	↻	↻	↻	CE	
		g	oz									EN 12275	EN 566
3435	NANO 22 EXPRESS KS 12 cm	53	1.9	NANO 22 - Red	21	8	9	17	86	52	22	B	•
				NANO 22 - Titanium	21	8	9	17	86	52			
2890	NANO 22 EXPRESS KS 18 cm	55	1.9	NANO 22 - Red	21	8	9	17	86	52	22	B	•
				NANO 22 - Titanium	21	8	9	17	86	52			
2482	MACH EXPRESS DYNEEMA 60 cm	73	2.6	NANO 22 - Titanium	21	8	9	17	86	52	22	B	•
				PHOTON WIRE - Orange	22	8	9	26	100	62			

2894U

3454



Grey / Blue / Blue

Grey / Blue / Blue

ORBIT EXPRESS KS

3454 12 cm - 101 g

3455 12 cm - 101 g

2894U 18 cm - 104 g

3363U 18 cm - 104 g

NEW

BEST SELLER

PAT. PEND.

ROCK CLIMBING

- A high-end utility draw for sport climbing
- Equipped with a straight gate Orbit carabiner on the bolt end and a bent gate Orbit on the rope end
- 16 mm Nylon dogbones features the Karstop Evo carabiner retainer on the rope end
- Available in 12 and 18 cm lengths
- Available in 2 colors

The Orbit carabiner is a solid workhorse for everyday climbing with great durability, smooth clipping action, lightweight engineering and the SphereLock closure which is an upgrade to the traditional keylock system with an even cleaner nose profile. 16 mm Nylon dogbones feature the Karstop Evo carabiner retainer on the rope end. Available in 12 and 18 cm lengths.

ORBIT EXPRESS KS 6 PACK

3458 12 cm

3459 12 cm

3437 18 cm

3438 18 cm

NEW

PAT. PEND.

3363U

3455



Grey / Blue / Fuchsia

Grey / Blue / Fuchsia

3458

3437

3459







3438



Grey / Blue / Blue



Grey / Blue / Fuchsia

Ref.	Product name	Weight		Product name								CE	
		g	oz									EN 12275	EN 566
3454	ORBIT EXPRESS KS 12 cm	101	3.6	ORBIT STRAIGHT GATE	24	7	8	20	98	58	22	B	•
3455				ORBIT BENT GATE	24	7	8	25	98	58			
2894U	ORBIT EXPRESS KS 18 cm	104	3.7	ORBIT STRAIGHT GATE	24	7	8	20	98	58	22	B	•
3363U				ORBIT BENT GATE	24	7	8	25	98	58			



ORBIT MIXED EXPRESS KS

3456 12 cm - 95 g
2900U 18 cm - 98 g

NEW PAT. PEND.

ROCK CLIMBING

- A sophisticated quickdraw for sport and trad climbing
- Equipped with a straight gate Orbit carabiner on the bolt end and a bent gate Orbit Wire on the rope end
- 16 mm Nylon dogbones features the Karstop Evo carabiner retainer on the rope end
- Available in 12 and 18 cm lengths

The Orbit Mixed Express is a great choice for sport and trad climbing. Equipped with the Orbit straight gate carabiner on the bolt end and the lightweight Orbit Wire carabiner on the rope end. The Orbit straight gate features the SphereLock closure which is an upgrade to the traditional keylock system with an even cleaner nose profile. The Orbit Wire carabiner features great durability, smooth clipping action and the lightweight engineering that C.A.M.P. is especially well known for. 16 mm Nylon dogbones feature the Karstop Evo carabiner retainer on the rope end. Available in 12 and 18 cm lengths.

ORBIT MIXED EXPRESS KS 6 PACK

3461 12 cm
3439 18 cm

NEW PAT. PEND.



ORBIT WIRE EXPRESS KS

3457 12 cm - 89 g
2897U 18 cm - 92 g

NEW

ROCK CLIMBING

- A perfect quickdraw for all-around climbing
- Equipped with two lightweight Orbit Wire carabiners
- 16 mm Nylon dogbones features the Karstop Evo carabiner retainer on the rope end
- Available in 12 and 18 cm lengths

The Orbit Wire Express is a perfect choice for all-around climbing. The Orbit Wire carabiner features great durability, smooth clipping action and the lightweight engineering that C.A.M.P. is especially well known for. 16 mm Nylon dogbones feature the Karstop Evo carabiner retainer on the rope end. Available in 12 and 18 cm lengths.

ORBIT WIRE EXPRESS KS 6 PACK

3460 12 cm
3440 18 cm

NEW

Ref.	Product name	Weight		Product name								CE	
		g	oz									EN 12275	EN 566
3456	ORBIT MIXED EXPRESS KS 12 cm	95	3.4	ORBIT STRAIGHT GATE	24	7	8	20	98	58	22	B	•
				ORBIT WIRE	22	7	8	27	98	61			
2900U	ORBIT MIXED EXPRESS KS 18 cm	98	3.5	ORBIT STRAIGHT GATE	24	7	8	20	98	58	22	B	•
				ORBIT WIRE	22	7	8	27	98	61			
3457	ORBIT WIRE EXPRESS KS 12 cm	89	3.1	ORBIT WIRE	22	7	8	27	98	61	22	B	•
				ORBIT WIRE	22	7	8	27	98	61			
2897U	ORBIT WIRE EXPRESS KS 18 cm	92	3.2	ORBIT WIRE	22	7	8	27	98	61	22	B	•
				ORBIT WIRE	22	7	8	27	98	61			



CABLE EXPRESS

- 2721 18 cm - 92 g - Gray
- 2722 18 cm - 92 g - Green
- 2723 23 cm - 107 g - Gray
- 2724 23 cm - 107 g - Green

SPORT CLIMBING, CLIMBING GYMS

- 6 mm steel cable perma-draws for fixing routes
- Available in 18 and 23 cm lengths and two colors

Steel cable perma-draws feature low-profile swages, expert finishing and tension-mounted flanges to protect the cable from the impact of dynamic stresses over time. The durable plastic coating makes the draw easy to grab for emergency clips and makes the steel braid core visible for inspection. Available in 2 sizes and 2 colors.

Ref.	Product name	Weight		kN	CE
		g	oz		
2721 2722	CABLE EXPRESS 18 cm	92	3.2	23	•
2723 2724	CABLE EXPRESS 23 cm	107	3.8	23	•



GYM SAFE CABLE EXPRESS

- 2725 18 cm - 345 g - Gray
- 2726 18 cm - 345 g - Green
- 2727 23 cm - 360 g - Gray
- 2728 23 cm - 360 g - Green

SPORT CLIMBING, CLIMBING GYMS

- 6 mm steel cable perma-draws for fixing routes
- Equipped with a burly 10 mm steel Oval quick Link and steel Gym Safe carabiner
- Available in 18 and 23 cm lengths and two colors

Steel cable perma-draws equipped with a burly 10 mm steel Oval quick link and our popular Gym Safe carabiner. The all-steel construction delivers maximum durability on fixed routes. The Cable Express draw features low-profile swages, expert finishing and tension-mounted flanges to protect the cable from the impact of dynamic stresses over time. The durable plastic coating makes the draw easy to grab for emergency clips and makes the steel braid core visible for inspection. The Gym Safe carabiner features a durable steel body and a soft aluminum bent gate that makes it clip like a high-end sport draw. The keeper pin is fixed with a hex screw to prevent theft and tampering, but is still easy to replace with wear and tear. Available in 2 sizes and 2 colors.

Ref.	Product name	Weight		Product name	kN	kN	kN	mm	mm	mm	kN	CE	
		g	oz									EN 12275	EN 566
		g	oz									kN	kN
2725 2726	GYM SAFE CABLE EXPRESS 18 cm	345	12.2	OVAL QUICK LINK STEEL 10 mm GYM SAFE	45	10	13	12	89	47	23	Q / B	•
2727 2728	GYM SAFE CABLE EXPRESS 23 cm	360	12.7	OVAL QUICK LINK STEEL 10 mm GYM SAFE	45	10	13	12	89	47	23	Q / B	•



GYM SAFE EXPRESS

NEW

- 3462 12 cm - 270 g
- 3209 18 cm - 273 g

CLIMBING GYMS

- Pre-assembled draws for fast and safe setting
- Special keeper pin on the Gym Safe carabiner helps prevent theft and keeps the carabiner in its proper position
- 16 mm Nylon dogbones available in 12 and 18 cm lengths

The Gym Safe Express comes pre-equipped with a burly 10 mm Steel Oval Quicklink for the bolt end and the Gym Safe steel keylock carabiner fixed in place with its special keeper pin on the rope end. The keeper pin serves a double function of helping to prevent theft and keeping the carabiner positioned in its proper orientation. It is fixed with a hex screw to prevent theft and tampering, but is still easy to replace with wear and tear.

Ref.	Product name	Weight		Product name	kN	kN	kN	mm	mm	mm	kN	CE	
		g	oz									EN 12275	EN 566
		g	oz									kN	kN
3462	GYM SAFE EXPRESS 12 cm	270	9.5	OVAL QUICK LINK STEEL 10 mm GYM SAFE	45	10	13	12	89	47	22	Q / B	•
3209	GYM SAFE EXPRESS 18 cm	273	9.6	OVAL QUICK LINK STEEL 10 mm GYM SAFE	45	10	13	12	89	47	22	Q / B	•

311918

3463



NEW

GYM SAFE EXPRESS PLUS

3463 12 cm - 305 g

311918 18 cm - 308 g

CLIMBING GYMS

- Specific quickdraw for climbing gyms and artificial walls
- Pre-equipped with a Gym Safe steel carabiner and a 10 mm steel oval quicklink
- Durable plastic material protects the dogbone and reduces wear and tear on the climbing wall
- Protectors also hold the carabiner and quicklink in the correct orientation and reduce noise when the quickdraw bangs against the wall
- 16 mm Nylon dogbones available in 12 and 18 cm lengths

Specific quickdraw for climbing gyms and artificial walls. Safety and durability are assured by the Gym Safe steel carabiner with Keylock closure, the 10 mm steel oval quicklink, and the Gym Safe Express Protectors. The two protectors are fixed at the ends of the dogbone to prevent wear and tear on the climbing wall and reduce noise when the quickdraw bangs on the wall. The protectors also prevent the rotation of the carabiner and quicklink ensuring that they will be loaded on the major axes. Protectors are removable and allow the hardware to be right or left facing depending on their placement and the route. The upper protector for the 10 mm quicklink can only be assembled when the quicklink is properly closed in order to prevent improper installations.









GYM SAFE EXPRESS PROTECTOR

3118 37 g

CLIMBING GYMS

- Replacement protectors for all Gym Safe Express series quickdraws
- Durable plastic material protects the dogbone and reduces wear and tear on the climbing wall
- It also holds the carabiner and quicklink in the correct orientation and reduces noise when the quickdraw bangs against the wall

Protectors made from durable plastic material for all Gym Safe Express series quickdraws (Gym Safe Express Plus and Gym Safe Express). Fixed to the ends of the dogbone, the protectors prevent wear and tear on the climbing wall and reduce noise when the quickdraw bangs on the wall. The protectors also prevent the rotation of the carabiner and quicklink ensuring that they will be loaded on the major axes. Protectors are removable and allow the hardware to be right or left facing depending on their placement and the route. The upper protector for the 10 mm quicklink can only be assembled when the quicklink is properly closed in order to prevent improper installations.

Ref.	Product name	Weight		Product name								CE	
		g	oz		kN	kN	kN	mm	mm	mm		EN 12275	EN 566
3463	GYM SAFE EXPRESS PLUS 12 cm	305	10.8	OVAL QUICK LINK STEEL 10 mm	45	10		12	89	47	22	Q / B	•
				GYM SAFE	24	8	13	24	99	58			
311918	GYM SAFE EXPRESS PLUS 18 cm	308	10.9	OVAL QUICK LINK STEEL 10 mm	45	10		12	89	47	22	Q / B	•
				GYM SAFE	24	8	13	24	99	58			



343012



343018

SLING STOP WIDE KS

343012 12 cm

343018 18 cm

NEW

ROCK CLIMBING

- Variable width webbing is particularly easy to handle
- 12 and 18 cm
- Rated to 22 kN
- Features the Karstop Evo carabiner retainer on the rope end

25 mm polyester dogbones with a variable width design that is thick and stiff in the middle and tapered at the ends for a profiled connection with the carabiners. The structure is designed for high-end sport climbing where they are easy to grab and handle and the wider cross section prevent twisting to keep the draws in their proper orientation, ready for fast and furious clipping on the sharp end. The rope-end opening is equipped with our Karstop Evo carabiner retainer – a strong urethane rubber keeper that fits snugly to the carabiner to prevent it from shifting.



290612



290618

SLING STOP KS

NEW

290612 12 cm

290618 18 cm

ROCK CLIMBING

- 12 and 18 cm
- Rated to 22 kN
- Features the Karstop Evo carabiner retainer on the rope end

16 mm Nylon dogbones equipped with the Karstop Evo carabiner retainer on the rope end. The Karstop Evo is a strong urethane rubber keeper that fits snugly to the carabiner to prevent it from shifting. The bolt-end opening remains looser to help the draw situate in line with the rope path.



290712



290718

SLING STOP KS DYNEEMA®

NEW

290712 12 cm

290718 18 cm

ALPINISM, ROCK CLIMBING

- 12 and 18 cm
- Rated to 22 kN
- Features the Karstop Evo carabiner retainer on the rope end

Lightweight 11 mm Dyneema® dogbones equipped with the Karstop Evo carabiner retainer on the rope end. The Karstop Evo is a strong urethane rubber keeper that fits snugly to the carabiner to prevent it from shifting. The bolt-end opening remains looser to help the draw situate in line with the rope path.

Ref.	Product name	Weight		Strength	Material	CE
		g	oz	kN		EN 566
343012	SLING STOP WIDE KS 12 cm	19	0.7	22	Polyester	•
343018	SLING STOP WIDE KS 18 cm	25	0.9	22	Polyester	•
290612	SLING STOP KS 12 cm	17	0.6	22	Polyamide	•
290618	SLING STOP KS 18 cm	20	0.7	22	Polyamide	•
290712	SLING STOP KS DYNEEMA 12 cm	9	0.3	22	Dyneema®	•
290718	SLING STOP KS DYNEEMA 18 cm	11	0.4	22	Dyneema®	•



KARSTOP

112102 Large - Package 10 pcs - 2 g

Fits 16-25 mm webbing. Molded Vibram® rubber keeper used to fix carabiner to webbing. This prevents the carabiner from flipping out of position where it can be cross-loaded.

2771



2772



2773



PROMO COVER

2771 25 mm - 8 g

2772 16 mm - 7 g

2773 11 mm - 4.5 g

- Available in 11, 16 and 25 mm widths
- Sold in packs of 5

C.A.M.P. logoed rubber dogbone covers for logo visibility in photo shoots or promotions.



ANCHORING DEVICES AND WEBBING



The North face of Cerro Torre. Matteo De Zaiacomo in action during the first ascent of "Brothers in Arms" (1200 m, 7a, A2, 90°) climbed in 2022 with David Bacci and Matteo Della Bordella. In the background, the huge and complex southwest face of Fitz Roy, which rises more than two kilometers from the glacier below. Further to the right stands the Aguja Poincenot © Matteo Della Bordella

ANCHORING DEVICES AND WEBBING

Gyro and Enigma swivels: real innovation

The Gyro and Enigma swivel devices deliver a whole new level of positioning possibilities for complex anchors. The Gyro is a compact swivel system where every attachment point rotates independently to prevent twisting, tangling and misalignments. The system is already popular in our via ferrata lanyards and ice tool tethers. The range of Gyro anchor devices includes the compact Gyro1, the Gyro3 with three connection points, and the Gyro4 with four connection points that can be used in parallel to double the breaking strength and working load limit. The Enigma is a sophisticated swivel that can be taken apart completely so components can be attached directly to the shackles without connectors. The shackles also tilt in addition to turning to help with alignment.



Webbing materials: Dyneema®, polyester, nylon

C.A.M.P. offers slings and dogbones for quickdraws constructed from Dyneema®, Polyester and Nylon. Each material has distinctive properties that make it excel in a given environment. The biggest differences have to do with size, weight and elongation (which determines how well the material absorbs energy under load). We recommend polyester or nylon for shorter slings like the dogbones on quickdraws where its wider structure also creates more surface area to hold carabiners in place and offers something to grab when working projects. Polyester and nylon are also the right choice for variable length loops requiring knots of any kind. But polyester or nylon has fast become an impractical choice for longer runners considering all of the benefits of Dyneema®. Dyneema® is the trade name for high modulus polyethylene (HMPE). It is special material with many practical benefits for climbing and rigging. First, it has a much lower density than standard polyester or nylon with a specific gravity of 0.97 versus 1.38 so it weighs less, but can still be used to perform most of the same functions for safety and rigging as polyester or nylon. Second, HMPE fibers actually have a much higher tensile strength than polyester or nylon so less material is needed to achieve equal strengths to polyester or nylon webbing. This allows full-strength Dyneema® slings to be thinner in addition to lighter. Other benefits of HMPE are that it does not absorb water and has greater resistance to degradation from chemicals and UV light. These are properties specifically worth considering vis-à-vis specific environmental conditions and climbing styles. Ice and alpine climbers, for instance, are well-served by Dyneema® because the slings will not soak up water or ice up in wet conditions. Rock climbers can realize huge weight and bulk savings by using Dyneema® runners. Although Dyneema® has many great properties, it also has a few drawbacks. HMPE is slick and has a low melting point so it is not recommended for friction hitches, such as the Prusik or Klemheist. The material will slide against itself too easily or melt in the event of a large fall. Dyneema® also has very little stretch while polyester or nylon webbing is less static so it can actually help reduce the impact force of a fall. This can become an important consideration in systems that otherwise lack components designed for the absorption and dissipation of dynamic force. But the reality is that the rope and friction from anchor points take the brunt of the force in a standard climbing scenario, so used in conjunction with a good dynamic rope and proper protection, Dyneema® runners are a prime choice.

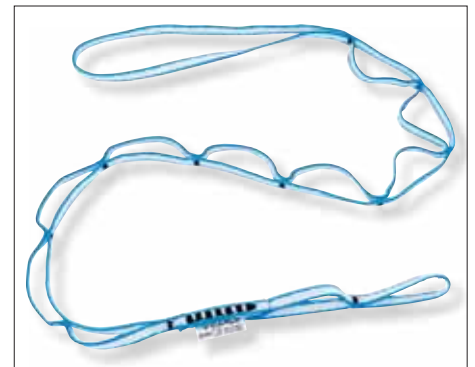

CATEGORY LEADERS



1ST CLASS
ENIGMA
3259



1ST CLASS
GYRO3
2940

Anchoring webbings

New	Ref.	Product name	Weight		Strength	Material	CE			STANDARD	ANSI
			g	oz	kN		EN 354	EN 795/B	EN 566	TS 16415	Z359.18
	3130060	EXPRESS SLING 60 cm	55	1.9	25	Polyester	•	•	•	•	•
NEW	3130080	EXPRESS SLING 80 cm	75	2.6	25	Polyester	•	•	•	•	•
	3130120	EXPRESS SLING 120 cm	110	3.9	25	Polyester	•	•	•	•	•
NEW	3130160	EXPRESS SLING 160 cm	140	4.9	25	Polyester	•	•	•	•	•
	3211030	8.5 mm EXPRESS DYNEEMA RUNNER 30 cm	12	0.4	22	Dyneema®			•		
	3211060	8.5 mm EXPRESS DYNEEMA RUNNER 60 cm	21	0.7	22	Dyneema®			•		
	3211120	8.5 mm EXPRESS DYNEEMA RUNNER 120 cm	39	1.4	22	Dyneema®			•		
	3211240	8.5 mm EXPRESS DYNEEMA RUNNER 240 cm	75	2.6	22	Dyneema®			•		
	3210030	10.5 mm EXPRESS DYNEEMA RUNNER 30 cm	11	0.4	22	Dyneema®			•		
	3210060	10.5 mm EXPRESS DYNEEMA RUNNER 60 cm	20	0.7	22	Dyneema®			•		
	3210120	10.5 mm EXPRESS DYNEEMA RUNNER 120 cm	37	1.3	22	Dyneema®			•		
	3210240	10.5 mm EXPRESS DYNEEMA RUNNER 240 cm	72	2.5	22	Dyneema®			•		
	321201	DAISY TWIST STANDARD - Grey	118	4.2	22	Polyamide			•		
	321202	DAISY TWIST LONG - Light blue	134	4.7	22	Polyamide			•		
	321301	DAISY CHAIN STANDARD - Grey	102	3.6	22	Polyamide			•		
	321302	DAISY CHAIN LONG - Light blue	116	4.1	22	Polyamide			•		
	3214	DAISY CHAIN DYNEEMA	42	1.5	22	Dyneema®			•		

Multiple anchoring devices

New	Ref.	Product name	Weight		Strength	Working load Max	Hole diameter	CE		ANSI
			g	oz	kN	kN	mm	PPE-R/11.135	Z359.18	
NEW	3259	ENIGMA	116	4.1	23	5		•	•	
NEW	3260	GYRO1	76	2.7	25	5	2 x ø16	•	•	
NEW	2940	GYRO3	155	5.5	26	5	3 x ø16	•	•	
NEW	3109	GYRO4	265	9.4	26	5	4 x ø16	•	•	
NEW	1393	SWIVEL	150	5.3	35	3		•		

ANCHORING DEVICES AND WEBBING

Anchoring webbings



EXPRESS SLING
3130



8.5 mm EXPRESS DYNEEMA® RUNNER
3211



10.5 mm EXPRESS DYNEEMA® RUNNER
3210



DAISY TWIST
3212



DAISY CHAIN
3213



DAISY CHAIN DYNEEMA®
3214

Multiple anchoring devices



NEW
ENIGMA
3259



NEW
GYRO1
3260



NEW
GYRO3
2940

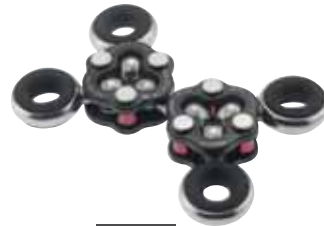

NEW
GYRO4
3109



NEW
SWIVEL
1393

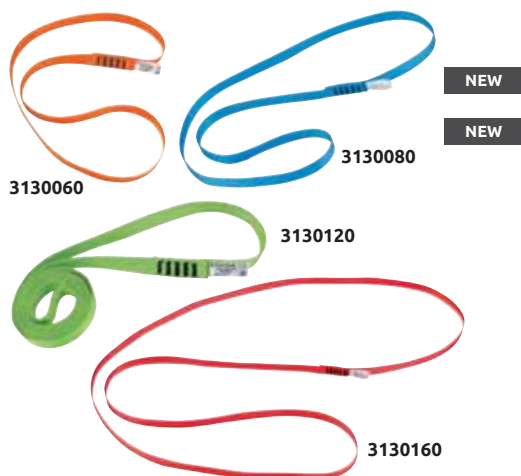

EXPRESS SLING

3130060 60 cm
 3130080 80 cm
 3130120 120 cm
 3130160 160 cm

ALPINISM, ROCK CLIMBING, RIGGING, RESCUE

- Available in 4 lengths: 60, 80, 120 and 160 cm
- Breaking load 25 kN

Sewn rings of 20 mm polyester webbing available in 4 lengths: 60, 80, 120 and 160 cm. Sturdy and easy to handle, they are ideal for use in anchors and rigging.

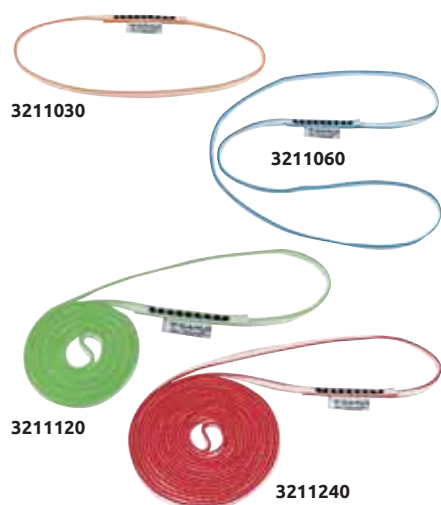

8.5 mm EXPRESS DYNEEMA® RUNNER

3211030 30 cm
 3211060 60 cm
 3211120 120 cm
 3211240 240 cm

ALPINISM, ROCK CLIMBING

- Available in 4 lengths: 30, 60, 120 and 240 cm
- Breaking load 22 kN

Sewn rings of 8.5 mm Dyneema® webbing available in 4 lengths: 30, 60, 120 and 240 cm. Extremely thin and super lightweight, they are ideal for making low-profile extendable alpine draws, building alpine anchors and for use in ice anchors like V-Threads or A-Threads where the narrow profile can fit through ice screw holes with ease. Use the 60 cm length for extendable alpine draws combined with lightweight carabiners. The 120 and 240 cm are perfect for anchors on big missions. The thin profile makes them extremely compact for carrying and the hydrophobic properties of Dyneema® means they will not absorb moisture or become weaker when wet.

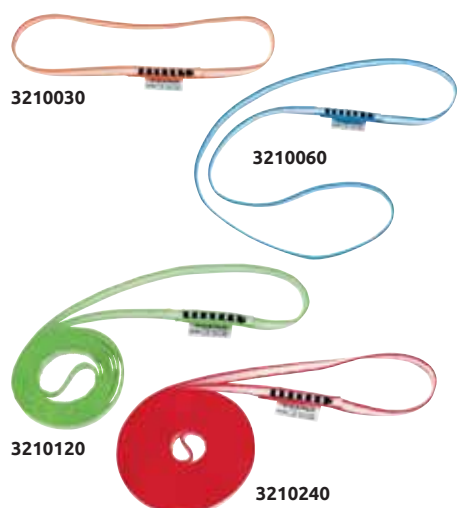

10.5 mm EXPRESS DYNEEMA® RUNNER

3210030 30 cm
 3210060 60 cm
 3210120 120 cm
 3210240 240 cm

ALPINISM, ROCK CLIMBING

- Available in 4 lengths: 30, 60, 120 and 240 cm
- Breaking load 22 kN

Sewn loops of 10.5 mm Dyneema® webbing available in 4 lengths: 30, 60, 120 and 240 cm. Lightweight and low profile, they are ideal for building anchors and for use as extendable quickdraws. The 120 and 240 cm lengths are long enough to be equalized in anchors and the 60 cm is the right length for tripling as extendable quickdraws with lightweight carabiners.

Ref.	Product name	Weight		Strength	Material	CE			STANDARD	ANSI
		g	oz	kN		EN 354	EN 795/B	EN 566	TS 16415	Z359.18
3130060	EXPRESS SLING 60 cm	55	1.9	25	Polyester	•	•	•	•	•
3130080	EXPRESS SLING 80 cm	75	2.6	25	Polyester	•	•	•	•	•
3130120	EXPRESS SLING 120 cm	110	3.9	25	Polyester	•	•	•	•	•
3130160	EXPRESS SLING 160 cm	140	4.9	25	Polyester	•	•	•	•	•
3211030	8.5 mm EXPRESS DYNEEMA RUNNER 30 cm	12	0.4	22	Dyneema®			•		
3211060	8.5 mm EXPRESS DYNEEMA RUNNER 60 cm	21	0.7	22	Dyneema®			•		
3211120	8.5 mm EXPRESS DYNEEMA RUNNER 120 cm	39	1.4	22	Dyneema®			•		
3211240	8.5 mm EXPRESS DYNEEMA RUNNER 240 cm	75	2.6	22	Dyneema®			•		
3210030	10.5 mm EXPRESS DYNEEMA RUNNER 30 cm	11	0.4	22	Dyneema®			•		
3210060	10.5 mm EXPRESS DYNEEMA RUNNER 60 cm	20	0.7	22	Dyneema®			•		
3210120	10.5 mm EXPRESS DYNEEMA RUNNER 120 cm	37	1.3	22	Dyneema®			•		
3210240	10.5 mm EXPRESS DYNEEMA RUNNER 240 cm	72	2.5	22	Dyneema®			•		



DAISY TWIST

321201 Standard - Grey
321202 Long - Light blue

ALPINISM, ROCK CLIMBING, AID CLIMBING

- Spiral construction addresses the dangerous consequences of cross-clipping adjacent loops
- Available in 2 lengths (48 and 54 inches, 122 and 137 cm)

The spiral construction of the Daisy Chain Twist addresses one of the main concerns with traditional daisy chains where the user clips a single carabiner through two adjacent loops creating a situation where they are secured by nothing more than the single bar tack between the loops instead of the 22 kN strength of the entire loop. Robust 16 mm Nylon construction with special machine-driven bar tacks distribute the load multi-directionally. Available in 2 lengths (48 and 54 inches, 122 and 137 cm).



DAISY CHAIN

321301 Standard - Grey
321302 Long - Light blue

ALPINISM, ROCK CLIMBING, AID CLIMBING

- Standard Nylon daisy chain
- Available in 2 lengths (48 and 54 inches, 122 and 137 cm)

16 mm Nylon daisy chain with standard construction. Available in 2 lengths (48 and 54 inches, 122 and 137 cm). The bottom loop has a twist so that it girth hitches cleanly to a climbing harness.

NOTE: never cross-clip two loops of a daisy chain—full strength comes from the main bartack and not the individual loop stitches.

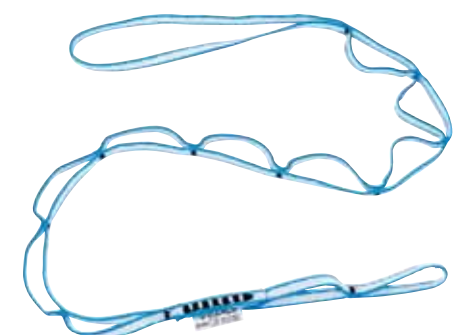

DAISY CHAIN DYNEEMA®

3214

ALPINISM, ROCK CLIMBING, AID CLIMBING

- Rated to 22 kN

Standard Daisy Chain with 11 loops constructed from lightweight, hydrophobic Dyneema webbing. The bottom loop has a twist so that it girth hitches cleanly to a climbing harness.

NOTE: never cross-clip two loops of a daisy chain—full strength comes from the main bartack and not the individual loop stitches.

Ref.	Product name	Weight		Strength	Material	CE
		g	oz	kN		EN 566
321201	DAISY TWIST STANDARD - Grey	118	4.2	22	Polyamide	•
321202	DAISY TWIST LONG - Light blue	134	4.7	22	Polyamide	•
321301	DAISY CHAIN STANDARD - Grey	102	3.6	22	Polyamide	•
321302	DAISY CHAIN LONG - Light blue	116	4.1	22	Polyamide	•
3214	DAISY CHAIN DYNEEMA	42	1.5	22	Dyneema®	•



Video

ENIGMA

3259

NEW

1ST CLASS

PAT. PEND.

INDUSTRIAL, RIGGING, RESCUE

- Innovative swivel that can be opened completely for direct attachment to the pivoting shackles without the use of connectors
- Incredible range of orientations and movements
- Stainless steel core with ball bearings
- Aluminum alloy main body and rings

The Enigma is a completely openable swivel with large pivoting shackles that allow for connections directly to both metal and textile devices without the use of connectors. The rotating swivel combined with the pivoting shackles allow for an incredible range of orientations and movements. The unique design opens the swivel and both shackles with a single screw (key provided with product). The safety locking system is independent and opposite to the working direction of the device for easy and safe assembly. Stainless steel core with ball bearings combine with an aluminum alloy main body and rings for a very high breaking strength (23 kN) and a high working load limit (5 kN). Shackles have a large opening (18 mm) and large inner working space to allow for the connection of several devices to the same ring.



GYRO1

3260

NEW

INDUSTRIAL, RIGGING, RESCUE

- The most compact swivel on the market
- Maximum freedom of movement with connection points that rotate independently
- The innovative design prevents the accumulation of dirt and makes inspection easy
- Main structure is carbon steel with a double corrosion preventive coating
- Attachment points in aluminum alloy and stainless steel

The Gyro1 delivers maximum freedom of movement in a compact size with a robust design. The ball connection allows for both rotation and tilting between the two rings in all directions. The size and shape are more compact than other swiveling products on the market. The innovative design also prevents the accumulation of dirt and makes inspection easy. The main structure is carbon steel with a double corrosion preventive coating. Two attachment points, one in aluminum alloy and the other in stainless steel. Includes two removeable silicon anti-rotation inserts. Working load limit: 3 kN. Minimum breaking strength: 25 kN.

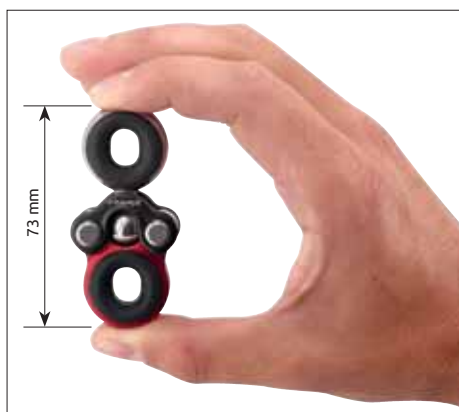

Ref.	Product name	Weight		Strength	Working load Max	Hole diameter	CE	ANSI
		g	oz	kN	kN	mm		
3259	ENIGMA	116	4.1	23	5		PPE-R/11.135	Z359.18
3260	GYRO1	76	2.7	25	5	2 x Ø16		



Video



GYRO3

2940

NEW

1ST CLASS

DESIGN PAT. PEND.

INDUSTRIAL, RIGGING, RESCUE

- Swiveling rigging plate equipped with 3 connection points
- Countless possibilities of connection and great freedom of movement
- The innovative design prevents the accumulation of dirt and makes inspection easy
- Main structure is carbon steel with a double corrosion preventive coating
- Attachment points are stainless steel

A compact and extremely versatile rigging plate equipped with three connection points. The Gyro3 rotates at all three connection points which allows for countless possibilities of connection between different elements that need freedom of movement. Just a few possibilities include self-orienting multi-anchoring, multiple connections to a harness, cross-hauling operations, Tyrolean traverses, and complex rescue procedures. The innovative design prevents the accumulation of dirt and makes inspection easy. The main structure is carbon steel with a double corrosion preventive coating. Swivel balls and attachment points are stainless steel. Includes three removeable silicon anti-rotation inserts. Working load limit: 3 kN. Minimum breaking strength: 26 kN.



GYRO4

3109

NEW

DESIGN PAT. PEND.

INDUSTRIAL, RIGGING, RESCUE

- Swiveling rigging plate equipped with 4 connection points
- Countless possibilities of connection and great freedom of movement even in the most complex rigging scenarios
- The innovative design prevents the accumulation of dirt and makes inspection easy
- Main structure is carbon steel with a double corrosion preventive coating
- Attachment points are stainless steel

A revolutionary 3D swiveling rigging plate equipped with four connection points that rotate independently to allow them to be self-orienting even in the most complex rigging scenarios. The Gyro4 system allows for countless possibilities of connection between different elements that need freedom of movement. The innovative design prevents the accumulation of dirt and makes inspection easy. Main structural flanges are carbon steel with a double corrosion preventive coating. Swivel balls and attachment points are stainless steel. Includes four removeable silicon anti-rotation inserts. Working load limit: 3 kN. Minimum breaking strength: 26 kN. Working load limit and minimum breaking strength are doubled when the two main bodies are oriented horizontally.

Ref.	Product name	Weight		Strength	Working load Max	Hole diameter	CE	ANSI
		g	oz	kN	kN	mm		
2940	GYRO3	155	5.5	26	5	3 x ø16	•	•
3109	GYRO4	265	9.4	26	5	4 x ø16	•	•



GYRO ANTI-ROTATION INSERTS

3268 10 pcs

NEW

Spare silicon anti-rotation inserts compatible with all Gyro swiveling devices. Package of 10 pcs.



SWIVEL

1393

NEW

INDUSTRIAL, RIGGING, RESCUE

- Aluminum alloy swivel with sealed ball bearings

A robust aluminum alloy swivel with sealed ball bearings designed to prevent ropes from twisting and tangling. Working load limit: 3 kN. Minimum breaking strength: 35 kN.

Ref.	Product name	Weight		Strength	Working load Max	Hole diameter	CE
		g	oz	kN	kN	mm	
1393	SWIVEL	150	5.3	35	3		•



"Fram" is the name of the legendary ship of the 20th century ice pioneers Nansen and Amundsen. Marcin Tomaszewski and Paweł Hałdaś called the route they opened on the Oqatsut wall in Greenland by the same name feeling like pioneers in their own right (700 m, M5, A3 e C2) © Paweł Hałdaś

ROPE TOOLS



ROPE TOOLS

Matik: Safe, intuitive, awesome!

As more and more people take up the wonderful sport of climbing, the more the need grows for super-safe, intuitive gear. This trend is what drove C.A.M.P. to develop the Matik – an auto-locking belay and descending device with sophisticated geometry to lower the impact force of a fall and a braking system called Anti-Panic that automatically reengages the cam and locks the rope if the handle is pulled too far for a safe rate of descent. Other notable features of the Matik include the robust construction with a hot-forged aluminum body and precision cast stainless steel components for the rope bearing surfaces.



Swing: Adjustable belay lanyard

The Swing allows the climber to adjust their position on an anchor with great ease: just pull the tail to tighten up or feed rope through the blocking device for slack. The position is adjustable from 20-100 cm and can be adjusted even when it is under tension. Unlike other designs that are not certified for dynamic loads, the Swing is dynamically tested according to the UIAA 109 standard: fall factor 2, mass of 80 kg and adjustable head adjusted to 80% of its maximum length for an impact force <10 kN.

Ascenders: Maximum innovation

The series of C.A.M.P. ascenders marks an evolutionary advance in safety, longevity and performance for ropes and ascenders alike. On the Turbochest, Turbofoot Evo and Turbohand, small rollers prevent the friction and wear that normally occur where the rope rubs against the body of the ascender. In addition to the rollers, the Turbohand Pro also features an innovative rope guide on the bottom of the handle to help keep the rope aligned for better efficiency on long ascents. The Solo 2 has been distilled down to its simplest possible form to create a hyperlight handless ascender with super smooth action. Already popular in the areas of rope access, the line of micro ascenders from C.A.M.P. also promises to be a true game-changer for climbing and caving.



Pulleys: A complete line for every kind of need

10 high quality and super versatile models: they feature sophisticated designs with amazing strength and very high efficiency (up to 97%). From the super compact and lightweight Sphinx to the advanced Janus Pro, the line meets every kind of need. Most models are available in single and double sheave designs and the large models work with ropes up to 16 mm. Every model is also available in two different versions: the regular with self-lubricated bushings for light applications at low speed and the Pro with sealed ball bearings for high efficiency and intensive use at high speed. New to the range is the Turbolock: a smooth operating progress capture pulley that is designed to be compact, robust and efficient. It can be operated with one hand and the locking mechanism for opening and closing allows the rope to be inserted without removing the device from the anchor.



Più 2.0: Skinny, icy ropes need friction

The Piu 2.0 is designed to handle the new generation of skinny ropes that have become the preferred choice by high-end climbers even for everyday use. It locks easily on these ropes both in standard belay and auto-blocking belay mode. But the real trick is in the way it also allows for smooth operation without catching the rope when trying to pay out slack or during rappels. Using a variable notched design, the Piu 2.0 allows ropes to ride high in the wide parts of the notches when not fully loaded and then drive deeper into the pinched bottom part of the notches to hold the rope with more friction under the load of a fall. The system is generally more friendly to ropes and much safer with skinny, iced up ropes due to the higher friction ratio created by the variable notch design. On the other end of the spectrum where skinny ropes are not the norm, save your elbows by hauling your second on the Ovo belay plate which features long, wide slots that allow even thick, fuzzy ropes to pass through with ease.

CATEGORY LEADERS



1ST CLASS

MATIK
1041



1ST CLASS

TURBOHAND PRO
2635



BEST SELLER

PIÙ 2.0
0865

Descenders and belay devices

Ref.	Product name	Weight		Rope diameter min		Rope diameter max		CE	Standard	129
		g	oz	mm	in	mm	in			
1041	MATIK	276	9.7	Single 8.6	Single 0.34	Single 10.2		•		•
0865	PIU 2.0	80	2.8	Double 7.6-9	Double 0.3-0.35	Single 8.9-11	Single 0.35-0.43		•	•
2934	PIU 2.0 BELAY KIT	220	7.8							
086702	SHELL	50	1.8	Double 7.6-9	Double 0.3-0.35	Single 8.9-11	Single 0.35-0.43		•	•
092801	OTTO STANDARD	110	3.9	8	0.31	13	0.51			
054801	OTTO LARGE	130	4.6	8	0.31	13	0.51			

Ascenders

Ref.	Product name	Weight		Rope diameter		Rope diameter min		Rope diameter max		Length		Strength	CE			109
		g	oz	mm	in	mm	in	mm	in	cm	in		kN	EN 12841/B	EN 567	
264901	SWING	145	5.1	9.9	0.39								•			•
2634	TURBOHAND	185	6.5			8	0.31	13	0.51					•		•
0966	TURBOHAND GUIDE	16	0.6													
2635	TURBOHAND PRO	198	7.0			8	0.31	13	0.51					•		•
2256	TURBOCHEST	110	3.9			8	0.31	13	0.51					•		•
3261	TURBOFOOT EVO RIGHT	150	5.3			8	0.31	13	0.51							
3262	TURBOFOOT EVO LEFT	150	5.3			8	0.31	13	0.51							
2257	SOLO 2	95	3.4			8	0.31	13	0.51					•		•
1175	LIFT	95	3.4			8	0.31	13	0.51					•		•
0726	TURBOLOOP	120	4.2							95-150	37.4-59.06	5				
3041C	STANDARD AIDER	181	6.4							172	67.7	10				

Pulleys

Ref.	Product name	Weight		Inner sheave diameter		Rope diameter Max		Working load Max		Breaking load		Ball bearings	Brass bushing	Sheave material	CE	
		g	oz	mm	in	mm	in	kN	LBF	kN	LBF				EN 12278	EN 12278 EN 567 EN 12841/B
0108	ANDRY	100	3.5	26	1.06	12	0.47	1.5 kN x 2 = 3 kN	337 LBF x 2 = 674 LBF	22	4946		•	Polyamide		•
3185	TURBOLOCK	198	7.0	41	1.61	Min 8 Max 13	Min 0.31 Max 0.51	2.5 kN x 2 = 5 kN	562 LBF x 2 = 1124 LBF	23	5171	•		Aluminum alloy		•
2152	SPHINX	95	3.4	28	1.10	13	0.51	2 kN x 2 = 4 kN	450 LBF x 2 = 900 LBF	24	5396		•	Aluminum alloy		•
2153	SPHINX PRO	85	3.0	28	1.10	13	0.51	3 kN x 2 = 6 kN	675 LBF x 2 = 1349 LBF	25	5620	•		Aluminum alloy		•
2154	TETHYS	100	3.5	28	1.10	13	0.51	2 kN x 2 = 4 kN	450 LBF x 2 = 900 LBF	24	5396		•	Aluminum alloy		•
2155	TETHYS PRO	90	3.2	28	1.10	13	0.51	3 kN x 2 = 6 kN	675 LBF x 2 = 1349 LBF	25	5620	•		Aluminum alloy		•
2156	DRYAD	170	6.0	28	1.10	13	0.51	1 kN x 4 = 4 kN	225 LBF x 4 = 900 LBF	24	5396		•	Aluminum alloy		•
2157	DRYAD PRO	155	5.5	28	1.10	13	0.51	1.8 kN x 4 = 7 kN	405 LBF x 4 = 1574 LBF	26	5845	•		Aluminum alloy		•
2158	NAIAD	280	9.9	49	1.93	16	0.63	3.5 kN x 2 = 7 kN	787 LBF x 2 = 1574 LBF	44	9892		•	Aluminum alloy		•
2159	NAIAD PRO	300	10.6	49	1.93	16	0.63	5 kN x 2 = 10 kN	1124 LBF x 2 = 2248 LBF	46	10341	•		Aluminum alloy		•
2160	JANUS	400	14.1	49	1.93	16	0.63	2 kN x 4 = 8 kN	450 LBF x 4 = 1799 LBF	38	8543		•	Aluminum alloy		•
2161	JANUS PRO	425	15.0	49	1.93	16	0.63	3 kN x 4 = 12 kN	675 LBF x 4 = 2698 LBF	42	9442	•		Aluminum alloy		•

Ropes Courses

Ref.	Product name	Weight		Length		Construction	Breaking load		CE	
		g	oz	cm	in		kN	LBF	EN 17109	EN 17109
139711	TARZAN REWIND	138	4.9	45-85 cm	17.7-33.5 in	Rewind	15			•
139703	JUNGLE REWIND	120	4.2	45-85 cm	17.7-33.5 in	Rewind	15			•
139710	TARZAN	120	4.2	72 cm	28.3 in	Webbing	15			•
139702	JUNGLE	95	3.4	72 cm	28.3 in	Webbing	15			•
1397	BASIC 9 mm	155	5.5	78 cm	30.7 in	Rope	15			•
139708	JUNGLE SINGLE	52	1.8	59 cm	23.2 in	Webbing	15			•

ROPE TOOLS

Descenders and belay devices



MATIK
1041



PIU 2.0
0865



PIU 2.0 BELAY KIT
2934



SHELL
086702



STANDARD FIGURE 8
092801



LARGE FIGURE 8
054801

Ascenders



SWING
264901



TURBOHAND
2634



TURBOHAND PRO
2635



TURBOCHEST
2256



TURBOFOOT EVO
3261/3262



SOLO 2
2257



LIFT
1175



TURBOLOOP
0726



STANDARD AIDER
3041C

Devices for confined spaces



CABLE LADDER
0268

Pulleys



ANDRY PULLEY
0108



TURBOLOCK
3185



SPHINX
2152



SPHINX PRO
2153



TETHYS
2154



TETHYS PRO
2155



DRYAD
2156



DRYAD PRO
2157



NAIAD
2158



NAIAD PRO
2159



JANUS
2160



JANUS PRO
2161

Ropes Courses



WING 2
1025



TARZAN REWIND
139711



JUNGLE REWIND
139703



TARZAN
139710



JUNGLE
139702



BASIC 9 MM
1397



JUNGLE SINGLE
139708

MATIK

1041

1ST CLASS PAT. PEND.

SPORT CLIMBING



Video



- A revolutionary belay-descender device with assisted braking that delivers amazing safety and control
- Gradual camming action helps reduce the impact force of a fall and decreases wear and tear on the rope
- Anti-Panic system automatically blocks the rope if the user loses control of the descent
- Double-hinged lever and straight rope path make the descent feel very fluid and controlled
- Intuitive design eliminates the possibility of clipping a carabiner to the device if it is not completely closed
- Wide attachment hole allows the carabiner to rotate through the hole
- High-end manufacturing with hot-forged aluminum main body and precision-cast stainless steel for the critical components that come in contact with the rope
- For single dynamic ropes from 8.6 to 10.2 mm

The assisted braking action of the Matik derives from an innovative camming design that makes the device safe and easy on the climber, the belayer, the anchor and the rope. The Matik is built so the cam rotates in and comes in line with the rope before it captures the rope completely. This alignment creates a much larger contact area between the cam and the rope which makes the device more rope friendly than other assisted-braking devices, and the slight amount of slippage that occurs as the cam rotates into place reduces the impact force of a fall. This means less force on the bodies of the climber and belayer, and on the anchor! When lowering, the Anti-Panic system helps prevent one of the most common accidents occurring with the use of an assisted-braking device – losing control of the descent. The brake lever will automatically disengage causing the cam to automatically reengage if it is opened too quickly or if it is kept too far open where the speed of the descent can become unmanageable. This safety feature is particularly useful where there is little friction from rope drag between the belayer and the climber or during top-down descents where the Matik delivers a remarkable sense of safety and control. Users will also instantly notice that the Matik creates a very natural path for the rope that does not require looping or twisting of the rope during descent. Combined with the dynamic camming action that limits the impact of the fall, this natural rope path helps to reduce wear and tear on the rope. Other distinguishing features of the Matik include an improved method for inserting the rope that eliminates the possibility of clipping a carabiner to the device until it is completely closed, and robust construction with a hot-forged aluminum main body and precision-cast stainless steel for the critical components that come in contact with the rope.

NOTE: The assisted braking capability of the Matik does not relieve belayers of the need to adhere to the basic principles of belaying and rappelling. It is imperative to be attentive to the climber's progress and always keep control of the brake line.

CAMMING DESIGN REDUCES IMPACT FORCES AND STRESS OF THE ROPE

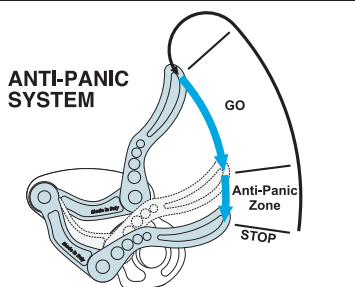
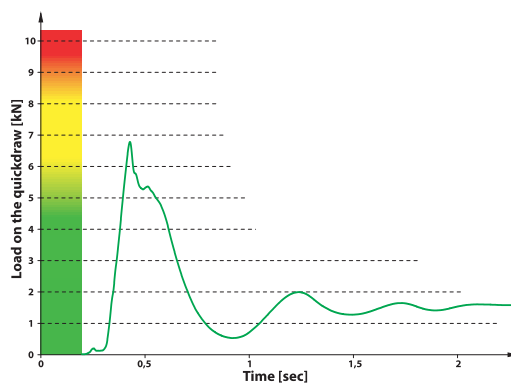
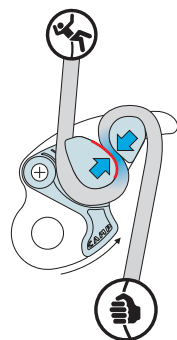

Test configuration (at C.A.M.P. in-house lab):

Rope: New dynamic single rope EN 892
 Diameter: 9.5 mm
 Mass: 80 kg
 Height of fall: 3 m
 Fall factor: 1



Ref.	Product name	Weight		Rope diameter min		Rope diameter max		CE	UIAA
		g	oz	mm	in	mm	in		
1041	MATIK	276	9.7	Single 8.6	Single 0.34	Single 10.2		EN 15151-1	129



PIU 2.0

086501 Light blue

086502 Gun metal

BEST SELLER

ALPINISM, MULTI-PITCH CLIMBING, ROCK CLIMBING

- Specifically designed for use with skinny ropes
- Can be rigged in auto-block mode for belaying two seconds
- Diagonal cable prevents the rope from rubbing and jamming

The Piu 2.0 has been designed to deliver optimal performance with the new generation of skinny ropes that have gained popularity in recent years. Using a variable notched design with smooth teeth on the brake side of the device along with narrower slots for the rope, the Piu 2.0 locks onto skinny ropes with more friction than other tube-style devices. Other features include the ability to set up the device in auto-block mode for belaying two seconds, a large rigging hole that allows a locking carabiner to rotate all the way through, a specially shaped hole that captures the nose of a keylock carabiner (specifically designed for use with the HMS Nitro and HMS Compact Lock carabiners) which can then be used as a lever for releasing tension if a second locks the device in auto-block mode, and a diagonal cable that prevents the rope from rubbing and jamming.



PIU 2.0 BELAY KIT

293401 Light blue

293402 Gun metal

ALPINISM, MULTI-PITCH CLIMBING, ROCK CLIMBING

- Kit includes the Piu 2.0 belay device and Core Lock carabiner

The Piu 2.0 uses a variable notched design with smooth teeth on the brake side of the device to lock onto ropes with more friction than other tube-style devices. Other features include the ability to set up the device in auto-block mode for belaying two seconds and a large rigging hole that allows a locking carabiner to rotate all the way through. The Core Lock is an extremely smooth HMS belay and rappel carabiner with a secure screw lock closure.



SHELL

086702 Gun metal

ROCK CLIMBING

- Simple, reliable belay and rappel device

The Shell is deceptively simple. Forged from 6082-T6 aluminum, the Shell has thicker walls than other tube style belay devices for better durability and heat dissipation.

Ref.	Product name	Weight		Rope diameter min		Rope diameter max		Standard	
		g	oz	mm	in	mm	in	EN 15151-2	129
0865	PIU 2.0	80	2.8	Double 7.6-9	Double 0.3-0.35	Single 8.9-11	Single 0.35-0.43	•	•
2934	PIU 2.0 BELAY KIT	220	7.8						
086702	SHELL	50	1.8	Double 7.6-9	Double 0.3-0.35	Single 8.9-11	Single 0.35-0.43	•	•



OTTO STANDARD

092801

ROCK CLIMBING, RESCUE

One of the lightest figure eights on the market, our Standard Figure Eight offers a smooth rappel with minimal impact on the rope. The secret to rappelling on a figure eight without twisting the rope is to always feed the rope from directly below—never hold the rope off to the side or at an angle.



OTTO LARGE

054801

ROCK CLIMBING, RESCUE

This slightly larger version of our Standard Figure Eight features a larger bottom hole that allows it to be used as a Sticht plate for belaying with single ropes. Due to the thick body, it also has very smooth action on rappels.

Ref.	Product name	Weight		Rope diameter min		Rope diameter max	
		g	oz	mm	in	mm	in
092801	OTTO STANDARD	110	3.9	8	0.31	13	0.51
054801	OTTO LARGE	130	4.6	8	0.31	13	0.51



SWING

264901 100 cm

MULTI-PITCH CLIMBING, ALPINISM, ROCK CLIMBING, RESCUE

- Adjustable positioning lanyard for attaching to anchors
- Ergonomic adjuster for quick and easy adjustment
- Unique design allows adjustment even under load
- 9.9 mm dynamic rope lanyard
- Adjustable from 20-100 cm
- Large connection hole with rubber keeper accommodates all sizes of locking carabiners
- Attaches to the tie-in point of the harness with a girth hitch
- Meets the strict UIAA 109 standard for energy absorption with a factor 2 fall

The Swing is an adjustable lanyard for quick, easy and safe positioning at anchors. The lanyard remains girth hitched to the tie-in point of the harness and attaches to the anchor using a standard locking carabiner. Once connected, simply pull on the free end of the lanyard to tension into the anchor or hold the device open with the thumb lever to release tension. Meets the strict UIAA 109 standard for energy absorption with a factor 2 fall. 9.7 mm dynamic rope. Adjustable from 20-100 cm.

Ref.	Product name	Weight		Rope diameter		CE	UIAA 109
		g	oz	mm	in		
264901	SWING	145	5.1	9.9	0.39	•	•



TURBOHAND

2634 R1 Red - Right

2634 L2 Grey - Left

DESIGN PAT. PEND.

AID CLIMBING, HIGH ALTITUDE, CAVING, INDUSTRIAL, RESCUE

- Roller makes upward glide super smooth and reduces wear and tear
- Toothed cam is finished with an anti-wear treatment and features drain holes for self cleaning
- Ergonomic rubber handle extends into the upper part of the spine for double-handed grip
- 3 large attachment points: two on the bottom and one at the top

The Turbohand ascender uses innovative technology and cutting-edge design to make climbing ropes safer, faster and easier. It features a special roller which not only helps with climbing efficiency by making the upward glide much smoother, but also reduces dangerous wear and tear on the device where the rope tends to rub on the body of a traditional ascender.

The ergonomic rubber handle extends into the upper part of the spine to allow for a double-handed grip. The handle and the rope are aligned on the same plane for the best handling and efficiency. Features three large attachment points, two on the bottom and one at the top, for optimal organization. The robust body is constructed from 3.5 mm aluminum alloy and the toothed cam is finished with a special anti-wear treatment and features drain holes to help prevent the build-up of mud and grit. The opening system is protected on both sides to prevent accidental openings.

The roller also allows the Turbohand to be rigged as a locking pulley for light hauling with a max load of 50 kg, 110 lbs. NOTE: This configuration is not intended for hauling or securing of bodies.

A stainless steel rope guide (Turbohand Guide, sold separately) can be attached to the bottom of the handle to align the rope for long ascents.



TURBOHAND GUIDE

0966 R Right

0966 L Left

DESIGN PAT. PEND.

A stainless steel rope guide that can be attached with two screws to the bottom of the Turbohand ascender to align the rope for long ascents. It also reinforces the main attachment point for increased resistance to wear and tear and prevents the carabiner from interfering with the rope.

Ref.	Product name	Weight		Rope diameter min		Rope diameter max		CE	
		g	oz	mm	in	mm	in	EN 12841/B	EN 567
2634	TURBOHAND	185	6.5	8	0.31	13	0.51	•	•
0966	TURBOHAND GUIDE	16	0.6						



TURBOHAND PRO

2635 R1 Red - Right

2635 L2 Grey - Left

1ST CLASS

DESIGN PAT. PEND.

AID CLIMBING, HIGH ALTITUDE, CAVING, INDUSTRIAL, RESCUE

- Roller makes upward glide super smooth and reduces wear and tear
- Removable rope guide optimally aligns the rope for long ascents
- Toothed cam is finished with an anti-wear treatment and features drain holes for self cleaning
- Ergonomic rubber handle extends into the upper part of the spine for double-handed grip
- 3 large attachment points: two on the bottom and one at the top

The Turbohand Pro ascender is the absolute top of the line for maximizing efficiency while ascending ropes. It features a roller which not only helps with climbing efficiency by making the upward glide much smoother, but also reduces dangerous wear and tear on the device where the rope tends to rub on the body of a traditional ascender. The removable rope guide at the bottom of the handle optimally aligns the rope for long ascents.

The ergonomic rubber handle extends into the upper part of the spine to allow for a double-handed grip. The handle and the rope are aligned on the same plane for the best handling and efficiency. Features three large attachment points, two on the bottom and one at the top, for optimal organization. The stainless steel rope guide reinforces the main attachment point for increased resistance to wear and tear. It also prevents the carabiner from interfering with the rope.

The robust body is constructed from 3.5 mm aluminum alloy and the toothed cam is finished with a special anti-wear treatment and features drain holes to help prevent the build-up of mud and grit. The opening system is protected on both sides to prevent accidental openings.

The roller also allows the Turbohand to be rigged as a locking pulley for light hauling with a max load of 50 kg, 110 lbs. NOTE: This configuration is not intended for hauling or securing of bodies.

Ref.	Product name	Weight		Rope diameter min		Rope diameter max		CE	
		g	oz	mm	in	mm	in	EN 12841/B	EN 567
2635	TURBOHAND PRO	198	7.0	8	0.31	13	0.51	•	•



Video

TURBOCHEST

2256

PAT. PEND.

CAVING, INDUSTRIAL, RIGGING

- Rollers increase climbing efficiency and decrease wear and tear on the device and ropes
- Super smooth action and increased safety on traversing maneuvers
- Thicker body plates and a shaped connection point reduce shifting between the device and the connector
- Can be rigged as a locking pulley for light hauling (max load 50 kg, 110 lbs)
- For ropes from 8 to 13 mm

A revolutionary chest ascender that features two rollers for a smooth interface with the rope. This not only helps with climbing efficiency by making the upward glide much smoother. It also reduces dangerous wear on the device where the rope tends to rub on the body of a traditional ascender. The perfectly profiled closure keeps the rope in line with the body of the device and the rollers to prevent the rope from escaping the device during tight pendulums and traverses. The toothed cam is finished with a special anti-wear treatment and features drain holes to help prevent the build up of mud, grit and ice. The main body also features drain holes along the rope path to allow grit and moisture to escape during use for better contact with the rope. Thicker body plates and a shaped connection point reduce wear on the device caused by shifting between the device and the connector (especially when used with steel connectors). This also keeps the device more in-line with the body during use. The opening mechanism is simple and secure with the ability to lock the device open for easier attachment and a removable pull cord that makes it easier to operate while wearing gloves. The rollers also allow the Turbochest to be rigged as a locking pulley for light hauling with a max load of 50 kg, 110 lbs. NOTE: This configuration is not intended for hauling or securing of bodies.



3261



3262

TURBOFOOT EVO

3261 Right

3262 Left

CAVING, INDUSTRIAL, RIGGING

- Rollers increase climbing efficiency and decrease wear and tear on the device and ropes
- Two different modes of use: free the cam to allow for immediate insertion and removal, or lock the cam to prevent the possibility of accidental releases
- Innovative straps provide a secure and ergonomic fit on boots
- Can be rigged as a locking pulley for light hauling (max load 50 kg, 110 lbs)
- For ropes from 8 to 13 mm
- Available in right and left versions

The beloved Turbofoot ascender gets an upgrade with the Turbofoot Evo. Integrated rollers deliver incomparable efficiency during climbing and low wear-and-tear on both the rope and on the ascender itself. Can be used in two different modes with the flick of a switch: free the cam to allow for immediate insertion and removal or lock the cam to prevent the possibility of accidental releases. The fastening straps adapt to any type of boot with auto-locking buckles for fast and secure adjustment. Mud and dirt can exit through special holes in the cam to help prevent build-up. Aluminum alloy main body. Precision cast stainless steel cam. Can also be used as a progress capture pulley (for light material hauling only, 50 kg max). For ropes from 8 to 13 mm. ATTENTION: the Turbofoot is intended for progression only and cannot be used as a life safety attachment.



Ref.	Product name	Weight		Rope diameter min		Rope diameter max		CE	
		g	oz	mm	in	mm	in	EN 12841/B	EN 567
2256	TURBOCHEST	110	3.9	8	0.31	13	0.51	•	•
3261	TURBOFOOT EVO RIGHT	150	5.3	8	0.31	13	0.51		
3262	TURBOFOOT EVO LEFT	150	5.3	8	0.31	13	0.51		



Video

SOLO 2 2257

CAVING, INDUSTRIAL, ALPINISM, RESCUE

- Light and compact ascender
- For ropes from 8 to 13 mm

A hyperlight, compact ascender with an ergonomic design that makes it very easy to use. The toothed cam is finished with a special anti-wear treatment and features drain holes to help prevent the build up of mud, grit and ice. The opening mechanism is simple and secure with the ability to lock the device open for easier attachment and a removable pull cord that makes it easier to operate while wearing gloves.



LIFT 1175

ALPINISM, INDUSTRIAL, ROCK CLIMBING, RIGGING, RESCUE

- CE certified

This extremely compact and lightweight ascender is very rope-friendly because it has no teeth or cam. It operates by pivoting the rope around a lever when weighted. Simply open the rotating side plate, insert the rope and close the plate, clip a carabiner in the hole, and start climbing.

Ref.	Product name	Weight		Rope diameter min		Rope diameter max		CE	
		g	oz	mm	in	mm	in	EN 12841/B	EN 567
2257	SOLO 2	95	3.4	8	0.31	13	0.51	•	•
1175	LIFT	95	3.4	8	0.31	13	0.51	•	•



TURBOLOOP 0726

ALPINISM, CAVING, INDUSTRIAL, RIGGING

- Foot loop for use in rope ascent
- Adjustable length from 95 to 150 cm
- Tensioning strap for the foot
- Reinforced main attachment point

The Turboloop is a simple, high-functioning foot loop for use in rope ascent, ideal for caving and big wall. The steel buckle allows for quick length adjustment from 95 to 150 cm. Features a tensioning strap for the foot and a reinforced main attachment point.

Ref.	Product name	Weight		Length		Strength
		g	oz	cm	in	kN
0726	TURBOLOOP	120	4.2	95-150	37.4-59.06	5



STANDARD AIDER

3041C

ALPINISM, AID CLIMBING

- 1" (25 mm) flat webbing for comfort and durability
- Two full-strength handle/clip-in loops

For climbers that prefer the traditional, alternating step aiders, the Standar version offers a sound design with steps that stay open. A carabiner loop at the bottom allows the aiders to be extended without collapsing the bottom step.

Ref.	Product name	Weight		Length		Strength
		g	oz	cm	in	kN
3041C	STANDARD AIDER	181	6.4	172	67.7	10

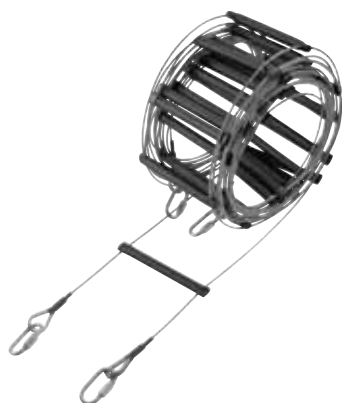

CABLE LADDER 10 m

0268 2300 g

CAVING

- 3 mm galvanised steel cable construction
- Includes 4 galvanised steel quicklinks for rigging

The 10 meter Speleo Ladder is the rig of choice for steep passages in caves. The 3 mm galvanised steel cable construction will resist deterioration in wet conditions. Designed for fast and secure fixing at the top and bottom with 30 nylon coated steps providing maximum security for adventurers.



ANDRY

0108

INDUSTRIAL, RIGGING

- Accessory Pulley
- Brass bushing
- Nylon sheave

An inexpensive pulley with a nylon wheel and zinc-plated steel side plates. A great basic accessory pulley for occasional hauling and fixing.

Ref.	Product name	Weight		Inner sheave diameter		Rope diameter Max		Working load Max		Breaking load		Ball bearings	Brass bushing	Sheave material	CE EN 12278
		g	oz	mm	in	mm	in	kN	LBF	kN	LBF				
0108	ANDRY	100	3.5	26	1.06	12	0.47	1.5 kN x 2 = 3 kN	337 LBF x 2 = 674 LBF	22	4946		•	Polyamide	•



Video



TURBOLOCK

3185

CAVING, INDUSTRIAL, RIGGING, RESCUE

- Progress capture pulley designed to be exceptionally compact, robust and efficient
- The locking mechanism for opening and closing allows the rope to be inserted without removing the device from the anchor
- For ropes from 8 to 13 mm
- The two attachment points allow for full rotation of the carabiners for maximum ease of use
- Very high efficiency (95%)

The TurboLock is a progress capture pulley designed to be exceptionally compact, robust and efficient. Specifically contoured for operation with one hand. The locking mechanism for opening and closing allows the rope to be inserted without removing the device from the anchor and it cannot be opened when the pulley is loaded to prevent accidental openings during use. Toothed cam is designed for an immediate and strong grab on ropes from 8 to 13 mm. The cam is enabled and disabled with a switch that is protected inside the flanges to prevent accidental activations. One movement to open the cam for easier insertion or removal of the rope or to use the device as a non-locking simple pulley. Two movements to enable the cam. The two attachment points (main attachment point and the becket hole) allow for the full rotation of carabiners for maximum ease of use. Large diameter sheave with sealed ball bearings for very high efficiency (95%). Robust construction features hot forged side plates, precision milled aluminum alloy sheave, and stainless steel cam, rivets and pins.

PULLEY

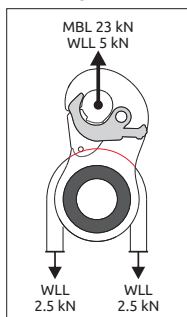

PROGRESS CAPTURE PULLEY

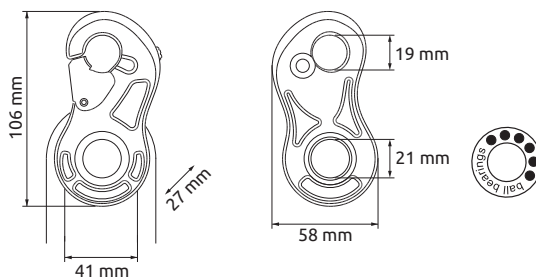
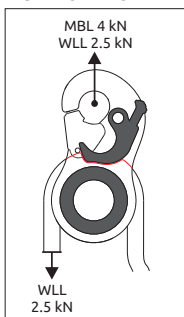

Ref.	Product name	Weight		Inner sheave diameter		Rope diameter Max		Working load Max		Breaking load		Ball bearings	Brass bushing	Sheave material	CE		
		g	oz	mm	in	mm	in	kN	LBF	kN	LBF				EN 12278	EN 567	EN 12841/B
3185	TURBOLOCK	198	7.0	41	1.61	Min 8 Max 13	Min 0.31 Max 0.51	2.5 kN x 2 = 5 kN	562 LBF x 2 = 1124 LBF	23	5171	•		Aluminum alloy	•	•	•



SPHINX 2152

ALPINISM, INDUSTRIAL

- Fixed side plates
- Self-lubricated brass bushings with 80% efficiency
- Super-compact aluminum alloy body and sheave, stainless steel axle
- Prusik-minding
- For ropes up to 13 mm

A super-compact, ultralight pulley with fixed side plates. The Sphinx is very easy to handle and convenient to carry on a harness while ski touring or mountaineering. The attachment hole is large enough to allow full rotation of a standard locking carabiner. Self-lubricated brass bushings are perfect for light applications at low speed. Unlike other pulleys with fixed side plates, the Sphinx allows for a prusik knot to be installed on one side (aramid cord suggested) making it an ideal pulley for rigging a haul system on route or managing crevasse rescues.



Video



SPHINX PRO 2153

ALPINISM, INDUSTRIAL, RIGGING, RESCUE

- Fixed side plates
- Sealed ball bearings for high efficiency (92%)
- Super-compact with aluminum alloy body and sheave, stainless steel axle
- Prusik-minding
- For ropes up to 13 mm

A super-compact, lightweight and easy-handling pulley with fixed side plates. The Sphinx Pro uses the same design as the Sphinx, but features sealed ball bearings for higher efficiency. The Sphinx Pro is designed for intensive use at higher speeds, but is small and light enough to easily carry on your harness or throw in your pack for ski touring and mountaineering. Unlike other pulleys with fixed side plates, the Sphinx Pro allows a prusik knot to be installed on one side (aramid cord suggested) making it an ideal pulley for rigging a haul system on route or managing crevasse rescues.



Video

Ref.	Product name	Weight		Inner sheave diameter		Rope diameter Max		Working load Max		Breaking load		Ball bearings	Brass bushing	Sheave material	CE EN 12278
		g	oz	mm	in	mm	in	kN	LBF	kN	LBF				
2152	SPHINX	95	3.4	28	1.10	13	0.51	2 kN x 2 = 4 kN	450 LBF x 2 = 900 LBF	24	5396		•	Aluminum alloy	•
2153	SPHINX PRO	85	3.0	28	1.10	13	0.51	3 kN x 2 = 6 kN	675 LBF x 2 = 1349 LBF	25	5620	•		Aluminum alloy	•



TETHYS

2154

ALPINISM, INDUSTRIAL

- Rotating side plates with a large opening that accommodates 2 carabiners
- Self-lubricated brass bushings with 80% efficiency
- Compact and lightweight aluminum alloy body and sheave, stainless steel axle
- Prusik-minding
- For ropes up to 13 mm

The Tethys is a compact, lightweight pulley designed to carry seamlessly on a harness and attach to a rope with ease. It features rotating side plates and a large attachment point that accommodates two carabiners. Self-lubricated brass bushings are perfect for light applications at low speed. Prusik knots can be installed on either side (aramid cord suggested) making it an ideal pulley for rigging a hauling system on route or managing crevasse rescues.



Video



TETHYS PRO

2155

ALPINISM, INDUSTRIAL, RIGGING, RESCUE

- Rotating side plates
- Sealed ball bearings for high efficiency (92%)
- Compact and lightweight aluminum alloy body and sheave, stainless steel axle
- Prusik-minding
- For ropes up to 13 mm

The Tethys Pro is a lightweight, high-efficiency, compact pulley designed to carry seamlessly on a harness and attach to ropes with ease. It features rotating side plates and a large attachment point that accommodates two carabiners. The Tethys Pro uses the same design as the Tethys, but features sealed ball bearings for higher efficiency and intensive use at higher speeds. Prusik knots can be installed on either side (aramid cord suggested) making it an ideal pulley for rigging a hauling system on route or managing crevasse rescues.



Video

Ref.	Product name	Weight		Inner sheave diameter		Rope diameter Max		Working load Max		Breaking load		Ball bearings	Brass bushing	Sheave material	CE EN 12278
		g	oz	mm	in	mm	in	kN	LBF	kN	LBF				
2154	TETHYS	100	3.5	28	1.10	13	0.51	2 kN x 2 = 4 kN	450 LBF x 2 = 900 LBF	24	5396		•	Aluminum alloy	•
2155	TETHYS PRO	90	3.2	28	1.10	13	0.51	3 kN x 2 = 6 kN	675 LBF x 2 = 1349 LBF	25	5620	•		Aluminum alloy	•



DRYAD 2156

INDUSTRIAL

- Compact double pulley
- Self-lubricated brass bushings with 80% efficiency
- Aluminum alloy body and sheaves, stainless steel axle
- Prusik-minding
- For ropes up to 13 mm

The Dryad is a remarkably compact double pulley designed for quick and easy haul systems. It features a large primary attachment hole that accommodates two carabiners and a lower becket hole for a single carabiner. Self-lubricated brass bushings are perfect for light applications at low speed. Prusik knots can be installed on either side (aramid cord suggested) making it particularly useful for crevasse rescue scenarios.



Video



DRYAD PRO 2157

INDUSTRIAL, RIGGING, RESCUE

- Compact double pulley
- Sealed ball bearings for high efficiency (92%)
- Aluminum alloy body and sheaves, stainless steel axle
- Prusik-minding
- For ropes up to 13 mm

The Dryad Pro is a high-efficiency compact double pulley designed for quick and easy haul systems. It uses the same design as the Dryad, but features sealed ball bearings for higher efficiency and intensive use at higher speeds. It has a large primary attachment hole that accommodates two carabiners and a lower becket hole for one carabiner. Prusik knots can be installed on either side (aramid cord suggested) making it particularly useful for crevasse rescue scenarios.



Video

Ref.	Product name	Weight		Inner sheave diameter		Rope diameter Max		Working load Max		Breaking load		Ball bearings	Brass bushing	Sheave material	CE EN 12278
		g	oz	mm	in	mm	in			kN	LBF				
2156	DRYAD	170	6.0	28	1.10	13	0.51	1 kN x 4 = 4 kN	225 LBF x 4 = 900 LBF	24	5396		•	Aluminum alloy	•
2157	DRYAD PRO	155	5.5	28	1.10	13	0.51	1.8 kN x 4 = 7 kN	405 LBF x 4 = 1574 LBF	26	5845	•		Aluminum alloy	•



Video

NAIAD 2158

INDUSTRIAL

- High-strength, multifunctional pulley
- Self-lubricated brass bushings with 90% efficiency
- Aluminum alloy body and large sheave, stainless steel axle
- Prusik-minding
- For ropes up to 16 mm

A high-strength, multifunctional pulley featuring a large sheave for high efficiency. The Naiad is ideal for high-load haul systems and complex operations. It features a main attachment hole that accommodates three carabiners, two secondary holes on the sides for positioning and a large lower bucket hole. Self-lubricated brass bushings are perfect for light applications at low speed. Prusik knots can be installed on either side (aramid cord suggested).



Video

NAIAD PRO 2159

INDUSTRIAL, RIGGING, RESCUE

- High-strength, multifunctional pulley
- Sealed ball bearings for high efficiency (97%)
- Aluminum alloy body and large sheave, stainless steel axle
- Prusik-minding
- For ropes up to 16 mm

A high-strength, multifunctional pulley featuring a large sheave for high efficiency. The Naiad Pro is ideal for high load haul systems and complex operations. It uses the same design as the Naiad with a main attachment hole that accommodates three carabiners, two secondary holes on the sides for positioning and a large lower bucket hole, but features sealed ball bearings for higher efficiency and intensive use at higher speeds. Prusik knots can be installed on either side (aramid cord suggested).

Ref.	Product name	Weight		Inner sheave diameter		Rope diameter Max		Working load Max		Breaking load		Ball bearings	Brass bushing	Sheave material	CE EN 12278
		g	oz	mm	in	mm	in	kN	LBF	kN	LBF				
2158	NAIAD	280	9.9	49	1.93	16	0.63	3.5 kN x 2 = 7 kN	787 LBF x 2 = 1574 LBF	44	9892		•	Aluminum alloy	•
2159	NAIAD PRO	300	10.6	49	1.93	16	0.63	5 kN x 2 = 10 kN	1124 LBF x 2 = 2248 LBF	46	10341	•		Aluminum alloy	•



JANUS

2160

INDUSTRIAL

- High-strength, multifunctional double pulley
- Self-lubricated brass bushings with 90% efficiency
- Aluminum alloy body and large sheaves, stainless steel axle
- Prusik-minding
- For ropes up to 16 mm

The Janus is a high-strength, multifunctional double pulley with large sheaves that has been optimized for complex haul systems and rescue operations. It features a main attachment hole that accommodates three carabiners, two secondary holes on the sides for positioning and a large lower bucket hole. Self-lubricated bushings are perfect for light applications at low speed. Prusik knots can be installed on either side (aramid cord suggested).



Video



JANUS PRO

2161

INDUSTRIAL, RIGGING, RESCUE

- High strength, multifunctional double pulley
- Sealed ball bearings for high efficiency (97%)
- Aluminum alloy body and large sheaves, stainless steel axle
- Prusik-minding
- For ropes up to 16 mm

The Janus Pro is a high-strength, multifunctional double pulley with large sheaves for high efficiency haul systems. It uses the same design as the Janus with a main attachment hole that accommodates three carabiners, two secondary holes on the sides for positioning and a large lower bucket hole, but features sealed ball bearings for higher efficiency and intensive use at higher speeds. Prusik knots can be installed on either side (aramid cord suggested).



Video

Ref.	Product name	Weight		Inner sheave diameter		Rope diameter Max		Working load Max		Breaking load		Ball bearings	Brass bushing	Sheave material	CE EN 12278
		g	oz	mm	in	mm	in	2 kN x 4	450 LBF x 4	kN	LBF				
2160	JANUS	400	14.1	49	1.93	16	0.63	2 kN x 4 = 8 kN	450 LBF x 4 = 1799 LBF	38	8543		•	Aluminum alloy	•
2161	JANUS PRO	425	15.0	49	1.93	16	0.63	3 kN x 4 = 12 kN	675 LBF x 4 = 2698 LBF	42	9442	•		Aluminum alloy	•



WING 2

1025

PAT. PEND.

ROPE COURSES & INSTITUTIONAL

- Unique closure for increased safety
- Guards serve a dual purpose by keeping clothing and hair away from the wheels and carrying backup lines
- Sealed steel ball bearings
- Stainless steel sheaves
- Maximum speed: 20 m/sec, 45 mph

The Wing introduces a new level of safety to zip lines with an elegant pivot locking mechanism. This system makes attaching participants to cable or rope faster and easier. It also ensures that the pulley cannot detach from the line while it is loaded. Features efficient steel bearings for high-speed adventure and stainless steel sheaves for durability. Thermoplastic guards prevent accidental entanglement from clothing and hair and carry backup lines along with the pulley on upright prongs.



WING 2 ARMS

1027 27 g

Replacement caps with the upright arms for carrying backup lines designed to fit with both the Wing 2 and older versions of the Wing.

Ref.	Product name	Weight		Inner sheave diameter		Rope diameter		Cable diameter		Working load max		Breaking load		Ball bearings	Sheave material	CE EN 17109
		g	oz	mm	in	mm	in	mm	in	kN	LBF	kN	LBF			
1025	WING 2	347	12.2	26	1.02	13	0.51	12	0.47	6	1349	15	3372	•	Stainless steel	•



TARZAN REWIND

139711

ROPE COURSES & INSTITUTIONAL

- Webbing lanyards with rewind elastic keep straps tight and out of the way when not in use
- Features an extra central loop for fixing a traveling pulley

A special version of the Jungle Rewind Lanyard with a central sling that has an attachment loop for fixing a traveling pulley. The lanyards are constructed from special rewind webbing designed to retract the lanyards to 45 cm when not in use keeping them tight to the body and out of the way. The twist ring attachment point optimally positions the lanyards when attached through the tie-in points on traditional harnesses. Not rated for use in via ferrata.



JUNGLE REWIND

139703

ROPE COURSES & INSTITUTIONAL

- Webbing lanyards with rewind elastic keep straps tight and out of the way when not in use

Double lanyard constructed from special rewind webbing designed to retract the lanyards to 45 cm when not in use keeping them tight to the body and out of the way. The twist ring attachment point optimally positions the lanyards when attached through the tie-in points on traditional harnesses. Not rated for use in via ferrata.

Ref.	Product name	Weight		Length		Construction	Breaking load	CE EN 17109
		g	oz	kN				
139711	TARZAN REWIND	138	4.9	45-85 cm	17.7-33.5 in	Rewind	15	•
139703	JUNGLE REWIND	120	4.2	45-85 cm	17.7-33.5 in	Rewind	15	•



TARZAN
139710

ROPE COURSES & INSTITUTIONAL

- Constructed from 23 mm semi-static webbing with an extra central loop for fixing a traveling pulley

A special version of the Jungle Lanyard with a central sling that has an attachment loop for fixing a traveling pulley. Constructed from 23 mm semi-static webbing with a twist ring attachment point that optimally positions the lanyard when attached through the tie-in points on traditional harnesses. Not rated for use in via ferrata.



JUNGLE
139702

ROPE COURSES & INSTITUTIONAL

- Constructed from 23 mm semi-static webbing

Double lanyard constructed from 23 mm semi-static webbing. The twist ring attachment point optimally positions the lanyards when attached through the tie-in points on traditional harnesses. Not rated for use in via ferrata.

Ref.	Product name	Weight		Length		Construction	Breaking load	CE EN 17109
		g	oz	cm	in		kN	
139710	TARZAN	120	4.2	72	28.3	Webbing	15	•
139702	JUNGLE	95	3.4	72	28.3	Webbing	15	•



BASIC 9 mm

1397

ROPE COURSES & INSTITUTIONAL

- 9 mm dynamic rope construction naturally absorbs energy

Double lanyard constructed from 9 mm dynamic rope naturally absorbs energy in the event of a fall. The durable transparent sheaths protect seams from cuts and abrasions. Supplied with rubber keepers to help prevent rotation of the connectors. Not rated for use in via ferrata.

JUNGLE SINGLE

139708

ROPE COURSES & INSTITUTIONAL

- Constructed from 23 mm semi-static webbing

Single lanyard constructed from 23 mm semi-static webbing with a twist ring attachment point that optimally positions the lanyard when attached through the tie-in points on traditional harnesses. Use a 10 mm quick link to fix it to the Wing Traveling Pulley for fast and secure attachments. Not rated for use in via ferrata.



Ref.	Product name	Weight		Length		Construction	Breaking load	CE EN 17109
		g	oz	cm	in		kN	
1397	BASIC 9 mm	155	5.5	78 cm	30.7 in	Rope	15	•
139708	JUNGLE SINGLE	52	1.8	59 cm	23.2 in	Webbing	15	•

ROPES



Janja Garnbret high up on the 360 meter tall Trbovlje chimney in Slovenia, the world's longest artificial multi-pitch route
© Jakob Schweighofer / Red Bull Content Pool

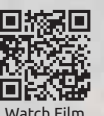

Watch Film

ROPES

Sleek and sophisticated single, half and twin ropes draw on the same kind of technical ingenuity and craftsmanship climbers have come to expect from C.A.M.P. The full range includes some dynamic ropes designed to meet the varied demands of all climbers and some semi-static ropes for caving and work and rescue.

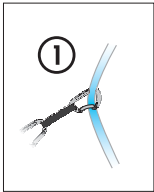

Single Ropes. Ropes certified to be used by themselves. Ideal for sport routes and everyday climbing where long rappels will not be required.

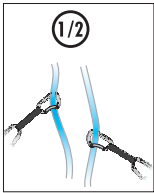

Half Ropes. A rope system comprised of two lines that are usually thinner than single ropes. The leader must tie into both lines, but clips only one line into each piece of pro making half ropes the preferred choice for wandering routes where gear must be placed in zigzag arrangements. Half ropes are also ideal on routes with shoddy protection and loose rock. A single line through a piece of pro or anchor places less stress on the gear than twin ropes and if one line gets damaged by falling rock, the other can still be intact and perfectly safe. Two seconds may follow the leader each tied into only one line.

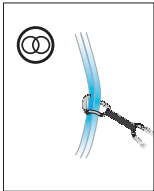

Twin Ropes. A rope system comprised of two lines that must be used together and in parallel at all times. The leader and the follower must be tied into both lines and both lines must be clipped into every piece of gear and anchors. Twin ropes are lighter than half ropes and excel on long, protectable routes where rappels often require the full length of the rope.

TECHNICAL INFORMATION

Dynamic climbing ropes are designed to absorb the impact of a fall in such a way that minimizes the amount of force put on the climber and the anchor system. The following ratings are used to help climbers compare factors like a rope's capacity to absorb energy, durability and strength.

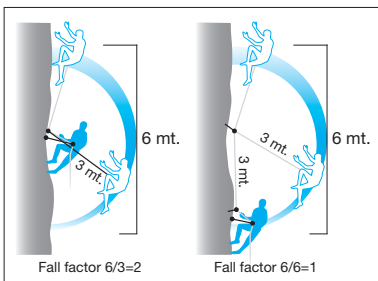

Fall Factor. The fall factor is used to evaluate the force of a fall on a climber. The fall factor is calculated by dividing the length of the fall by the length of the rope deployed. For example, if a climber falls from 2 meters above their last piece of protection with 20 meters of rope between leader and belayer, the resulting fall of ~4m would be calculated as 4m/20m, or 1/5, or .2 (fall factor). It is important to note that the fall factor is not simply a function of the length of a fall, but of the ratio of the length of the fall to amount of rope deployed. With more rope deployed, the rope can stretch more thereby absorbing more of the force generated by the fall. Additionally, the fall factor can only be applied as a theoretical function as it assumes there is no friction between the belay and the last piece of protection.

Impact Force. Impact force is a rating used to determine how well a rope absorbs the energy of a fall. All climbing ropes are rated with a maximum impact force that allows the consumer to compare the energy absorption capabilities of various ropes. The lower the maximum impact force, the more energy a rope can absorb thereby softening a fall. For single ropes, the maximum impact force must be less than 12 kN for a factor 1.77 fall with a mass of 80 kg. For half ropes, the maximum impact force must be less than 8 kN for a factor 1.77 fall with a mass of 55 kg. For twin ropes (tested with two parallel strands), the maximum impact force must be less than 12 kN for a factor 1.77 fall with a mass of 80 kg. The maximum impact force is calculated in a laboratory and simulates a severe fall that responsible climbers are unlikely to duplicate in the field.

CATEGORY LEADERS



1ST CLASS
SPECTRUM 8.9 mm
2235

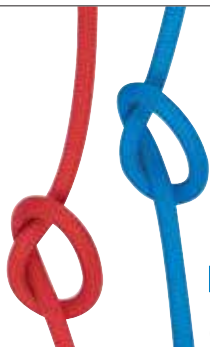

LIGHT&FAST
ISOTOP 7.6 mm
0803



BEST SELLER
HADRON 9.4 mm
0807

Number of UIAA Falls. The UIAA falls rating is used to determine how many severe falls a rope can withstand before breaking. Generally speaking, the higher the number the stronger the rope. Single ropes must withstand a minimum of five successive factor 1.77 falls with a mass of 80 kg. Double ropes must withstand a minimum of five successive factor 1.77 falls with a mass of 55 kg. Twin ropes (tested with two parallel strands) must withstand a minimum of twelve successive factor 1.77 falls with a mass of 80 kg.

- Dynamic Elongation: this is the stretch of the rope during the first UIAA test fall. For all climbing ropes, dynamic elongation cannot exceed 40%.
- Static Elongation: measured under a static load of 80 kg, it must not exceed 10% for single ropes, 12% for double ropes, or 10% for twin ropes which are tested with two parallel strands.

The life of your rope. The life of a rope depends on the frequency and intensity of use as well as exposure to UV rays and humidity which can gradually degrade the integrity of the fibers that comprise the rope. When stored under proper conditions, ropes can have a shelf life of up to five years before first use without affecting the rope's climbing life.

Follow these general guidelines to help evaluate the life of your rope:

- Intensive use: 3 months to 1 year
- Average use: 2 to 3 years
- Regular, but light use: 4 to 5 years
- Infrequent use: 10 years (this is the maximum recommended duration of use)

Replace your rope immediately if:

- It has held a major fall approaching fall factor 2
- Inspection reveals or even indicates damage to the core
- The sheath is seriously worn
- Any part of the rope has come in contact with damaging chemicals or agents
- There is the slightest doubt about its safety



DRY. A process where each strand of the sheath is treated with a hydrophobic coating to help repel moisture, dirt and grit which can damage the rope with intensive use over time. This is the first line of defense for the core of the rope and a feature present in all C.A.M.P. ropes.



FULL DRY. Hydrophobic treatment of the core and sheath. Full Dry is a great choice for alpinism and ice climbing where wet conditions are common. It is also a great way to increase the lifespan of a rope used primarily for rock climbing as the double treatment helps repel dirt and grit which can damage the rope with intensive use over time.



UNIFORM THREAD. An exclusive mechanical process used to optimize the uniformity of each thread during the braiding process. This uniformity helps the rope keep its shape over time and delivers consistent performance along the entire length of the rope.



MIDDLE MARK. Ink marks indicate the middle of the rope for easier management and safe descents.

Dynamic ropes

Ref.	Product name	Length			Weight			Type			Impact force kN		UIAA falls N°		Dynamic elongation (%)			Static elongation (%)		Sheath slippage mm	Dry	Full Dry	MiddleMark	Material	CE EN 892	UIAA 101			
		m	g/m	oz	Single	Half	Twin	Single	Half	Twin	Single	Half	Twin	Single	Half	Twin	Single	Half	Twin										
0803	ISOTOP 7.6 mm	20-30	40	1.4								6.3	10.1	7	16	28.5	26.5	9.2	5	0					Polyamide				
0804	MESON 7.7 mm	60-70-200	38	1.3								5.5	8.5	5	16	35.7	32.3	11.6	9.6	4					Polyamide				
0805	MESON 7.7 mm FULL DRY	60	38	1.3								5.5	8.5	5	16	35.7	32.3	11.6	9.6	4					Polyamide				
2234	BARYON 8.2 mm	50-60	41	1.4								5.6		7		34		11.4		5					Polyamide				
2235	SPECTRUM 8.9 mm	60-70-80-90	55	1.9								7.7	5.9	9	5	15	37	35.7	32.3	27.6	9.2	9.2	5.4	0			Polyamide		
0807	HADRON 9.4 mm	60-70-80	56	2.0								7.2		5		35.2		4.9		0					Polyamide				
0808	GLUON 9.7 mm	60-70-80	63	2.2								8.6		7		33.1		9.8		0					Polyamide				
2236	QUASAR 9.9 mm	60-70-80-200	66	2.3								8.7		7		31.9		6.3		5					Polyamide				
2237	CLUSTER 10.5 mm	50-60-200-600	69	2.4								8.1		9		34.0		5.3		0					Polyamide				
2238	MAGNON 11 mm	50-60-200	73	2.6								8.5		11		33.1		6.5		3					Polyamide				

Semi-static ropes

Ref.	Product name	Length			Weight			Static strength kN	Static strength w/ figure 8 knot kN	No. of factor 1 falls (100 kg)	Fall factor 0.3 impact force kN	Static elongation 50/150 kg (%)	Sheath slippage mm	Sheath %	Core %	Shrinkage in water %	Material	CE EN 1891	Type	EAC	UIAA 107
		m	g/m	oz/m	kN	kN															
2808	IRIDIUM 9 mm	50-200	53	1.9	23.6	14.2	15	4.1	3.7	0	40	60	2.8	Polyamide		B					
2809	IRIDIUM 10 mm	50-200	67	2.4	27.4	20.8	29	5.3	3.9	0	41	59	3	Polyamide		A					
2810	IRIDIUM 10.5 mm	50-200-600	68	2.4	29.2	19.5	22	5.1	3.1	0	38	62	2.3	Polyamide		A					
2813	IRIDIUM 10.5 mm HEATCORE	50-200	70	2.5	29.3	18	22	4.9	2.5	0	37	63	1.9	Polyamide		A					
2811	IRIDIUM 11 mm	50-200-600	76	2.7	34.8	22	>35	5.3	1.4	0	37	63	3	Polyamide		A					
2814	IRIDIUM 11 mm HEATCORE	50-200	77	2.7	32.7	20.7	53	5.2	2.3	0	35	65	2.4	Polyamide		A					
2812	IRIDIUM 12.5 mm	50-200	98	3.5	38.5	25.6	>100	5.2	3.3	0	39	61	3.5	Polyamide		A					
2815	PRIUM 10.5 mm	50-200-600	74	2.6	31	17.8	13	5.9	1.8	0	37	63	2.5	Polyamide / Polyester		A					
2816	PRIUM 11 mm	50-200-600	79	2.8	35.7	18.2	22	5.9	2.4	0	35	65	2	Polyamide / Polyester		A					

ROPES

Dynamic ropes



ISOTOP 7.6 mm
0803



MESON 7.7 mm
0804/0805



BARYON 8.2 mm
2234



SPECTRUM 8.9 mm
2235



HADRON 9.4 mm
0807



GLUON 9.7 mm
0808



QUASAR 9.9 mm
2236



CLUSTER 10.5 mm
2237



MAGNON 11 mm
2238

Semi-static ropes



IRIDIUM 9 mm
2808



IRIDIUM 10 mm
2809



IRIDIUM 10.5 mm
2810



IRIDIUM 10.5 mm
HEATCORE
2813



IRIDIUM 11 mm
2811



IRIDIUM 11 mm
HEATCORE
2814



IRIDIUM 12.5 mm
2812



PRIUM 10.5 mm
2815



PRIUM 11 mm
2816

Accessory Cords

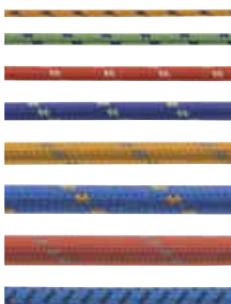

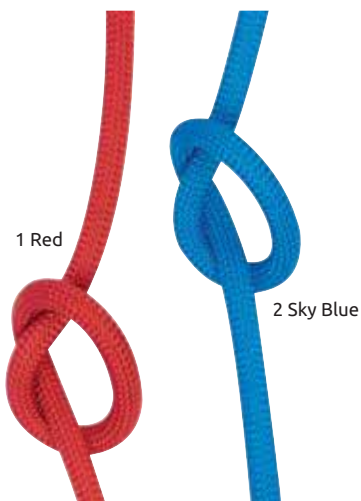

ISOTOP 7.6 mm

0803 Dry

LIGHT&FAST

MOUNTAINEERING, SKI MOUNTAINEERING

- Hyperlight dual-rated half and twin rope for light and fast glacier and snow travel
- Uniform Thread treatment with Dry treatment on the sheath

The Isotop is our skinniest rope, specifically designed for use in ski mountaineering and glacier travel. Available in 20 and 30 meter lengths. Note: Only use the Isotop as a single line on low angle terrain where the potential forces are lower than more technical, vertical climbing.



MESON 7.7 mm

0804 Dry

0805 Full Dry

MOUNTAINEERING, SKI MOUNTAINEERING, ALPINISM, MULTI-PITCH CLIMBING, ICE CLIMBING

- Dual rated half and twin rope for light and fast alpinism
- Uniform Thread treatment
- Available with Dry or Full Dry treatments

The prime line for technical ice climbing and wandering alpine routes where the very low impact force will still give precarious gear a fighting chance. Available with Dry or Full Dry treatments for extreme protection from moisture. Uniform Thread treatment delivers unparalleled consistency along the entire length of the rope and two coordinating colors optimize rope management. The Meson is also a great rope for ski mountaineering and glacier travel where the lower impact forces allow for the use of a single line.

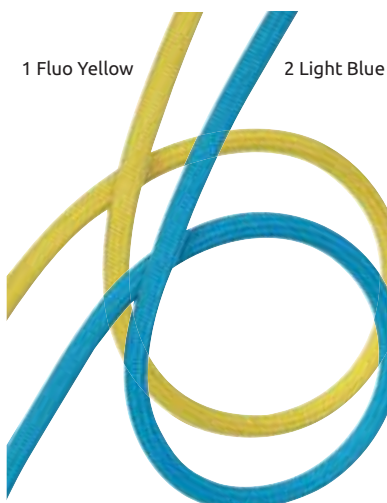

BARYON 8.2 mm

2234 Dry

ALPINISM, ROCK CLIMBING, MULTI-PITCH CLIMBING, ICE CLIMBING

- Light and thin half rope for technical climbing
- Uniform Thread treatment with Dry treatment on the sheath

A thin, technical half rope designed for advanced alpinism, ice climbing and rock climbing. The Baryon is notable for its light and fluid hand that delivers a solid grip even in adverse conditions.

Ref.	Product name	Length		Weight		Type			Impact force kN			UIAA Falls N°			Dynamic elongation (%)			Static elongation (%)			Sheath slippage mm	Dry	Full Dry	MiddleMark	Material	CE	UIAA
		m	g/m	oz	Single	Half	Twin	Single	Half	Twin	Single	Half	Twin	Single	Half	Twin	Single	Half	Twin	EN 892							
0803	ISOTOP 7.6 mm	20-30	40	1.4	•	•	6.3	10.1	7	16	28.5	26.5	9.2	5	0	•	•	Polyamide	•	•							
0804	MESON 7.7 mm	60-70-200	38	1.3	•	•	5.5	8.5	5	16	35.7	32.3	11.6	9.6	4	•	•	Polyamide	•	•							
0805	MESON 7.7 mm FULL DRY	60	38	1.3	•	•	5.5	8.5	5	16	35.7	32.3	11.6	9.6	4	•	•	Polyamide	•	•							
2234	BARYON 8.2 mm	50-60	41	1.4	•		5.6		7		34		11.4		5	•	•	Polyamide	•	•							



SPECTRUM 8.9 mm

2235 Dry

1ST CLASS

ALPINISM, ROCK CLIMBING, MULTI-PITCH CLIMBING, SPORT CLIMBING

- Triple-rated single, half and twin rope
- Uniform Thread treatment with Dry treatment on the sheath

Our lightest single line is primed for the mega-project where every gram counts. The Spectrum features a fluid hand for fast clipping and paying out slack. Due to its very low impact force, the Spectrum is also ideal for trad climbing where it places less force on protection than most thicker ropes. Available with our special Heatcore treatment that increases the ultimate breaking strength and reduces slippage between the sheath and core. Dry treatment on the sheath protects against grit and grime that can damage the rope with intensive use. Available in 60, 70, 80 and 90 meter lengths!



HADRON 9.4 mm

0807 Dry

BEST SELLER

ALPINISM, ROCK CLIMBING, MULTI-PITCH CLIMBING, SPORT CLIMBING

- Lightweight single rope
- Uniform Thread treatment with Dry treatment on the sheath

A lightweight single line with enough structure to deliver good durability for everyday use. Uniform Thread treatment delivers a high level of dimensional stability that keeps the rope round and soft. Dry treatment on the sheath protects against grit and grime that can damage the rope with intensive use.



GLUON 9.7 mm

0808 Dry

ALPINISM, ROCK CLIMBING, MULTI-PITCH CLIMBING, SPORT CLIMBING

- Multipurpose single rope
- Uniform Thread treatment with Dry treatment on the sheath

A versatile single rope that is ideal for everything from sport climbing to alpinism. 9.7 mm diameter strikes a perfect balance between durability, strength and lightweight. Uniform Thread treatment ensures good flexibility and handling over the life of the rope. Dry treatment on the sheath protects against grit and grime that can damage the rope with intensive use.

Ref.	Product name	Length		Weight		Type			Impact force kN			UIAA falls N°			Dynamic elongation (%)			Static elongation (%)			Sheath slippage mm	Dry	Full Dry	MiddleMark	Material	CE		UIAA
		m	g/m	oz	Single	Half	Twin	Single	Half	Twin	Single	Half	Twin	Single	Half	Twin	Single	Half	Twin	EN 892						101		
2235	SPECTRUM 8.9 mm	60-70 80-90	55	1.9	•	•	•	7.7	5.9	9	5	15	37	35.7	32.3	27.6	9.2	9.2	5.4	0	•		•	Polyamide	•	•		
0807	HADRON 9.4 mm	60-70-80	56	2.0	•			7.2			5			35.2			4.9			0	•		•	Polyamide	•	•		
0808	GLUON 9.7 mm	60-70-80	63	2.2	•			8.6			7			33.1			9.8			0	•		•	Polyamide	•	•		



1 White / Light Blue

2 White / Red

QUASAR 9.9 mm

2236 Dry

ALPINISM, ROCK CLIMBING

- High-quality and affordable single rope
- Uniform Thread treatment with Dry treatment on the sheath

A high-quality and affordable single rope for rock climbing and alpinism. 9.9 mm diameter delivers great strength and durability without being bulky and cumbersome. Uniform Thread treatment ensures good flexibility and handling over the life of the rope. Dry treatment on the sheath protects against grit and grime that can damage the rope with intensive use.



2 Red / Papaya Orange / Fluo Yellow

1 Light Blue / Green / Sky Blue

CLUSTER 10.5 mm

2237 Dry

ROCK CLIMBING, SPORT CLIMBING, CLIMBING GYMS, RESCUE

- Single rope for intensive everyday use
- Uniform Thread treatment with Dry treatment on the sheath

Single rope designed to hold up to intensive everyday climbing. The Cluster is ideal for indoor climbing, top-rope sessions and intensive outdoor use. The 10.5 mm diameter will hold up to repeated thrashings while maintaining a good hand and soft catch over the life of the rope.

MAGNON 11 mm

2238 Dry

ROCK CLIMBING, SPORT CLIMBING, CLIMBING GYMS, RESCUE

- Superstrong and durable single rope with reinforced sheath
- Uniform Thread treatment with Dry treatment on the sheath

A superstrong single rope with a reinforced sheath that features 30% more material making it both stronger and more resistant to abrasions and cutting. The Magnon is the right choice for the most intense terrain and frequent use where ropes are really put to the test.



1 Fluo Yellow / Green

Ref.	Product name	Length		Weight		Type			Impact force kN		UIAA Falls N°			Dynamic elongation (%)			Static elongation (%)			Sheath slippage mm	Dry	Full Dry	MiddleMark	Material	CE		UIAA	
		m	g/m	oz	Single	Half	Twin	Single	Half	Twin	Single	Half	Twin	Single	Half	Twin	Single	Half	Twin						EN 892	101		
2236	QUASAR 9.9 mm	60-70 80-200	66	2.3	•				8.7			7				31.9			6.3			5	•		•	Polyamide	•	•
2237	CLUSTER 10.5 mm	50-60 200-600	69	2.4	•				8.1			9				34.0			5.3			0	•		•	Polyamide	•	•
2238	MAGNON 11 mm	50-60-200	73	2.6	•				8.5			11				33.1			6.5			3	•		•	Polyamide	•	•

SEMI-STATIC ROPES

Semi-static ropes are broken out into two types to help users compare important factors like durability and strength. They are not designed to cushion the impact of a fall and should not be used for dynamic applications like climbing. They are designed primarily for rigging, work and rescue.

Type A. The strongest and most durable semi-static ropes. Excellent for accessing work areas and roping in when working at heights.

Type B. Smaller diameter semi-static ropes designed for more moderate work and rescue applications. Type B static ropes are both less durable and not as strong as Type A ropes.

Technical Information. Use the information in the charts below to determine the best semi-static rope for your needs. Generally speaking, ropes with larger diameters will be stronger and more durable. Use ratings like semi-static strength, number of falls and weight to compare ropes of similar diameters. Higher values for semi-static strength and number of falls indicate greater durability. For rescue applications, weight is often a concern as well.

IRIDIUM 9 mm

2808



White/Black - 501: 50 m, 2001: 200 m, 6001: 600 m

CAVING

- Type B semi-static line

Type B semi-static rope designed for technical activities where lightweight and minimal dimensions are a must. The small diameter is balanced with a compact sheath construction of 40 carriers and twisted yarns for increased abrasion resistance.

IRIDIUM 10 mm

2809



White/Black - 501: 50 m, 2001: 200 m

ALPINISM, ROCK CLIMBING, RIGGING, RESCUE

- Type A semi-static line

A light and minimalist semi-static rope that still guarantees a high strength. The small diameter is balanced with a compact sheath construction of 40 carriers for exceptional handling and twisted yarns for increased abrasion resistance.

IRIDIUM 10.5 mm

2810



White/Black - 501: 50 m, 2001: 200 m, 6001: 600 m



Red/Black - 502: 50 m, 2002: 200 m, 6002: 600 m



Yellow/Black - 503: 50 m, 2003: 200 m, 6003: 600 m



Black - 504: 50 m, 2004: 200 m, 6004: 600 m

ALPINISM, ROCK CLIMBING, RIGGING

- Type A semi-static line

The Iridium 10.5 delivers the best combination of handling and strength. The compact core combines with a 32 carrier sheath for superb handling and twisted yarns for a high level of resistance to abrasion.

Ref.	Product name	Length		Weight		Static strength	Static strength w/ figure 8 knot	No. of factor 1 falls (100 kg)	Fall factor 0.3 impact force	Static elongation 50/150 kg (%)	Sheath slippage	Sheath	Core	Shrinkage in water	Material	CE EN 1891	Type	EAC	UIAA 107
		m	g/m	oz/m	kN														
2808	IRIDIUM 9 mm	50-200	53	1.9	23.6	14.2	15	4.1	3.7	0	40	60	2.8	Polyamide	•	B			
2809	IRIDIUM 10 mm	50-200	67	2.4	27.4	20.8	29	5.3	3.9	0	41	59	3	Polyamide	•	A	•	•	
2810	IRIDIUM 10.5 mm	50-200 600	68	2.4	29.2	19.5	22	5.1	3.1	0	38	62	2.3	Polyamide	•	A	•	•	



White/Red/Black - **501**: 50 m, **2001**: 200 m

IRIDIUM 10.5 mm HEATCORE

2813

RIGGING, RESCUE

- Type A semi-static line
- Heatcore treatment

Semi-static rope manufactured with Heatcore technology that strongly links the sheath and core. The process increases the mechanical features of the rope, prevents sheath slippage and, most importantly, increases safety by preventing breaking of the sheath. It is the right choice for severe applications where the sheath will be stressed by edges, abrasions or aggressive mechanical devices. 32 carrier sheath made from twisted yarns.



White/Black - **501**: 50 m, **2001**: 200 m, **6001**: 600 m



Red/Black - **502**: 50 m, **2002**: 200 m, **6002**: 600 m



Yellow/Black - **503**: 50 m, **2003**: 200 m, **6003**: 600 m



Black - **504**: 50 m, **2004**: 200 m, **6004**: 600 m

IRIDIUM 11 mm

2811

RIGGING, RESCUE

- Type A semi-static line

The Iridium 11 mm is the right choice for riggers who need a super strong rope that remains compatible with most mechanical devices. The high-strength core combines with a 32 carrier sheath for good handling and twisted yarns for a very high level of abrasion resistance.



White/Red/Black - **501**: 50 m, **2001**: 200 m

IRIDIUM 11 mm HEATCORE

2814

RIGGING, RESCUE

- Type A semi-static line
- Heatcore treatment

11 mm semi-static rope designed for the heaviest applications where normal ropes could be compromised by exposure to edges, heavy abrasion and other stresses. Manufactured with Heatcore technology that strongly links the sheath and core; the process enhances mechanical features, prevents sheath slippage and, most importantly, improves safety by preventing breaking of the sheath. 32 carrier sheath made from twisted yarns.



White/Black - **501**: 50 m, **2001**: 200 m

IRIDIUM 12.5 mm

2812

RESCUE

- Type A semi-static line

Our strongest semi-static rope. Features a compact core and a 40 carrier sheath with twisted yarns to give the Iridium 12.5 mm a very high breaking strength and the ability to resist to a very high number of falls.

Ref.	Product name	Length		Weight		Static strength kN	Static strength w/ figure 8 knot kN	No. of factor 1 falls (100 kg)	Fall factor 0.3 impact force kN	Static elongation 50/150 kg (%)	Sheath slippage mm	Sheath %	Core %	Shrinkage in water %	Material	CE EN 1891	Type	EAC	USA 107
		m	g/m	oz/m	g/m														
2813	IRIDIUM 10.5 mm HEATCORE	50-200	70	2.5	29.3	18	22	4.9	2.5	0	37	63	1.9	Polyamide	•	A			
2811	IRIDIUM 11 mm	50-200 600	76	2.7	34.8	22	>35	5.3	1.4	0	37	63	3	Polyamide	•	A	•	•	
2814	IRIDIUM 11 mm HEATCORE	50-200	77	2.7	32.7	20.7	53	5.2	2.3	0	35	65	2.4	Polyamide	•	A			
2812	IRIDIUM 12.5 mm	50-200	98	3.5	38.5	25.6	>100	5.2	3.3	0	39	61	3.5	Polyamide	•	A	•	•	



White/Red - **501**: 50 m, **2001**: 200 m, **6001**: 600 m

PRIUM 10.5 mm

2815

ALPINISM, ROCK CLIMBING, RIGGING, RESCUE

- Type A semi-static line

The Prium uses a polyester sheath for low elongation and increased resistance to the effects of humidity, dirt and dust. The super strong polyamide core combines with the 32 carrier sheath for good handling and twisted yarns for a very high level of abrasion resistance. The suppleness of the Prium 10.5 mm makes it a great choice for use with ascenders and descenders.



White/Red - **501**: 50 m, **2001**: 200 m, **6001**: 600 m

PRIUM 11 mm

2816

RIGGING, RESCUE

- Type A semi-static line

The Prium 11 mm is the right choice for users demanding a rope with superior strength that remains compatible with most mechanical devices. A super strong core combines with a 32 carrier sheath made from twisted yarns.

Ref.	Product name	Length		Weight		Static strength kN	Static strength w/ figure 8 knot kN	No. of factor 1 falls (100 kg)	Fall factor 0.3 impact force kN	Static elongation 50/150 kg (%)	Sheath slippage mm	Sheath %	Core %	Shrinkage in water %	Material	CE EN 1891	Type	EAC	USA 107
		m	oz/m	g/m	oz/m														
2815	PRIUM 10.5 mm	50-200 600	74	2.6	31	17.8	13	5.9	1.8	0	37	63	2.5	Polyamide/ Polyester	•	A			
2816	PRIUM 11 mm	50-200 600	79	2.8	35.7	18.2	22	5.9	2.4	0	35	65	2	Polyamide/ Polyester	•	A			



2 mm



3 mm



4 mm



5 mm



6 mm



7 mm



8 mm



5.5 mm
aramid

CORDS

ALPINISM, ROCK CLIMBING

A wide range of accessory cords available in numerous widths to handle a large variety of applications. The 5.5 mm aramid is especially strong and is a great choice for rigging lightweight rappels and anchors. The hydrophobic, abrasion-resistant properties of the aramid material make it great for extended outdoor use.

Ref.	Product name	Length		Weight		Strength kN	CE EN 564
		m	oz	g/m	oz		
0817	CORD 2 mm	120	0.1	2.5	0.1	0.8	
0818	CORD 3 mm	120	0.2	7	0.2	2.5	
0822	CORD 4 mm	120	0.4	10	0.4	4	•
0823	CORD 5 mm	120	0.5	15	0.5	6	•
0824	CORD 6 mm	120	0.8	23	0.8	10	•
0825	CORD 7 mm	120	1.1	30	1.1	12	•
0826	CORD 8 mm	120	1.5	43	1.5	18	•
0827	CORD 5.5 mm ARAMID	50	0.9	25	0.9	17.5	•

HARNESSES



Complete focus and concentration from Claudia Ghisolfi on "TCT" (9a) in Gravere, Italy © Diego Borello

HARNESSES

Construction and Design. C.A.M.P. harnesses are best known for their amazing blend of lightweight, comfort and durability. We offer individual models specifically designed for every kind of adventure with different kinds of construction in the various ranges. Webbing loop construction is the most simple and allows for the widest range of adjustment. It is used in the Energy series and Topaz II harnesses. Smart Webbing Technology construction uses special webbing that integrates breathable material with full strength strands for excellent breathability, good load distribution, and great packability. It is used in the new hyperlight Escape, Velocity and Aurora harnesses. Continuous Load Webbing construction integrates transparent, lightweight yarns into the weave for the best load distribution across the webbing and exceptional packability. It is used in the minimalist Alpine Flash and the hyperlight Alp Race and Alp CR harnesses.



Alp Race: the new lightest harness in the world. The Alp Race is the lightest harness in the world at 68 grams. C.A.M.P. has been the pioneer of hyperlight harnesses through ages. First with the XLH 130 in 2003, then beating the 100 gram barrier with the Alp 95, and most recently with the Alp Racing that introduced load webbing for an unsurpassed combination of hyper lightweight and comfort. The Alp Race uses a new monofilament Nylon material combined with UHMW polyethylene (Ultra High Molecular Weight Polyethylene) to create a harness that is hyperlight, ultra-packable, breathable and durable. The Alp Race is absolutely the reference for ski mountaineering competitions while the Alp CR features adjustable leg loops that can be fully opened making it the right choice for ski touring, ski mountaineering and mountaineering.



Energy: climbers asked, we answered. The Energy met with immediate success when it was launched in 2015. At the time, it was our second lightest sport climbing harness, but also our most affordable. This combination of top level design and materials at an entry-level price point has made it our best seller since its inception. We have taken the tried and true design of the Energy and expanded it into an entire range of harnesses for rock climbers of every kind. The Energy remains with fixed leg loops for a performance fit. The Energy CR3 is a lightweight, versatile design for any kind of climber. The Energy CR4 provides a very broad fit range in just two sizes. The Energy Junior is a lightweight, simple and safe harness for children that follows the design of the Energy CR3. The Energy Nova (perhaps the model we are most proud of) has been tuned for a precise fit on female climbers not just in simple attributes like the length of the rise or ratios in sizing between the waist and legs – the Energy Nova actually features our high end conical construction on the waist belt that profiles to the shape of the hips for the very best fit on the market.



Escape, Velocity, Aurora: minimalist design, top-level performance. The Escape, Velocity and Aurora are our new top-level climbing harnesses that use innovative Smart Webbing Technology construction with special webbing that integrates breathable material with full strength strands for excellent breathability, good load distribution, and great packability. The soft 3D mesh liner delivers a high level of comfort and breathability and all of the models have all the features needed for technical rock climbing and alpine climbing at the highest levels.

Manufacturing. C.A.M.P. is an ISO 9001:2015 certified manufacturer and meets the Module D of the Regulation (EU) 2016/425 which means every harness is sewn to an exact specification with an extremely tight tolerance for any variance. Before each run, we calibrate the machines and we source only the highest-quality materials in order to ensure maximum quality, durability and uniformity.



Harnesses classification and marking according to EN 12277

- Full body harness (**type A**): Harness which fits at least around the upper part of the body and the thighs. Note: This type of harness will support an unconscious person in a head up position.
- Small body harness (**type B**): Full body harness according to type A intended for people up to 40 kg. Note: This type of harness is particularly suitable for people with an undeveloped or ill defined waistline.
- Sit harness (**type C**): Harness in the form of a waist belt and connecting sub-pelvic support suitably arranged to support a conscious body in a sitting position.
- Chest harness (**type D**): Harness which fits around the upper part of the body around the chest and under the armpits. Note 1: This type of harness alone cannot support a person in the hanging position without permanent injury in less than one minute. Note 2: A type D harness should only be used in combination with a type C harness.



CATEGORY LEADERS

				
1ST CLASS	1ST CLASS	LIGHT&FAST	LIGHT&FAST	BEST SELLER
ESCAPE 3474	ALP CR 3169	ALP RACE 3168	VELOCITY 3475	ENERGY CR 3 2870



Climbing

New	Ref.	Product name	Sizes	Weight Size (M)						No-Twist Belay Loop	Haul Loop	Drop Seat	Stitched loop for HUB racking carabiners	CE
				g	oz	B - Waist (cm / in)		C - Legs (cm / in)						
NEW	3475	VELOCITY	XS	270	9.5	62-72	24.4-28.3	48-52	18.9-20.5				2	•
			S			69-79	27.2-31.1	52-56	20.5-22					
			M			76-86	29.9-33.9	56-60	22-23.6					
			L			83-93	32.7-36.6	60-64	23.6-25.2					
			XL			90-100	35.4-39.4	64-68	25.2-26.8					
NEW	3474	ESCAPE	S	305	10.8	69-79	27.2-31.1	50-60	19.7-23.6				2	•
			M			76-86	29.9-33.9	55-65	21.6-25.6					
			L			83-93	32.7-36.6	60-70	23.6-27.6					
			XL			90-100	35.4-39.4	65-75	25.6-29.5					
NEW	3476	AURORA	XS	300	10.6	58-68	22.8-26.8	47-57	18.5-22.4				2	•
			S			65-75	25.6-29.5	52-62	20.5-24.4					
			M			72-82	28.3-32.3	57-67	22.4-26.4					
			L			79-89	31.1-35	62-72	24.4-28.3					
	2720	ALPINE FLASH	XS	300	10.6	64-74	25.2-29.1	47-57	18.5-22.4				4	•
			S			70-80	27.6-31.5	51-61	20.1-24.0					
			M			76-86	29.9-33.9	55-65	21.7-25.6					
			L			82-92	32.3-36.2	59-69	23.2-27.2					
	2871	ENERGY CR 4	XS-M	380	13.4	62-82	24.4-32.3	46-56	18.1-22		•			•
			M-XL			76-100	29.9-39.4	52-62	20.5-24.4					
	2870	ENERGY CR 3	XS	375	13.2	58-68	22.8-26.8	39-49	15.3-19.3					•
			S			65-75	25.6-29.5	49-59	19.3-23.2					
			M			72-82	28.3-32.3	55-65	21.6-25.6					
			L			79-89	31.1-35	60-70	23.6-27.6					
	2869	ENERGY	XS	305	10.8	58-68	22.8-26.8	45-53	17.7-20.9					•
			S			65-75	25.6-29.5	50-58	19.7-22.8					
			M			72-82	28.3-32.3	55-63	21.6-24.8					
			L			79-89	31.1-35	60-68	23.6-26.8					
	2872	ENERGY NOVA	XS	345	12.2	56-66	22-26	52-62	20.5-24.4					•
			S			63-73	24.8-28.7	56-66	22-26					
			M			70-80	27.6-31.5	60-70	23.6-27.6					
			L			77-87	30.3-34.2	64-74	25.2-29.1					
	0205	FLINT	S	460	16.2	65-77	25.6-30.3	52-62	20.5-24.4		•	•		•
			M			75-87	29.5-34.3	56-66	22.1-26.0					
			L			85-97	33.5-38.2	60-70	23.6-27.6					

Alpinism-Ski Mountaineering

Ref.	Product name	Sizes	Weight Size (M)						Drop seat	CE
			g	oz	B - Waist (cm / in)		C - Legs (cm / in)			
3168	ALP RACE	S	68	2.4	78-88	30.7-34.7	53-58	20.9-22.8		•
		M			85-95	33.4-37.4	58-63	22.8-24.8		
		L			92-102	36.2-40.1	63-68	24.8-26.8		
		XL			99-109	39-43	68-73	26.8-28.7		
3169	ALP CR	S	94	3.3	78-88	30.7-34.7	55-65	21.6-25.6	•	•
		M			85-95	33.4-37.4	60-70	23.6-27.6		
		L			92-102	36.2-40.1	65-75	25.6-29.5		



Groups

Ref.	Product name	Sizes	Weight						CE
			g	oz	B - Waist (cm / in)		C - Legs (cm / in)		
3215	TOPAZ II	One-size	620	21.9	60-110	23.6-43.3	38-70	15-27.6	•
3216	GROUP III	One-size	390	13.8	50-110	19.7-43.3	30-70	11.8-27.6	•

Chest harnesses

Ref.	Product name	Sizes	Weight				CE
			g	oz	A - Chest (cm / in)		
0909	FIG. 8 CHEST	XS-L	290	10.2	61-110	24.0-43.3	•

Junior

Ref.	Product name	Sizes	Weight								CE		
			g	oz	B - Waist (cm / in)		A - Chest (cm / in)		C - Legs (cm / in)		EN 12277/B	EN 12277/C	EN 12277/D
2873	ENERGY JR	One-size	280	9.9	48-60	18.9-23.6			38-48	15.0-18.9		•	
0657	BAMBINO	One-size	370	13.1			50-85	19.7-33.5	30-60	11.8-23.6	•		
0900	BAMBINO CHEST	One-size	160	5.6			61-70	24.0-27.6					•

HARNESSES

Climbing



NEW
VELOCITY
3475



NEW
ESCAPE
3474



NEW
AURORA
3476



ALPINE FLASH
2720



ENERGY CR 4
2871



ENERGY CR 3
2870



ENERGY
2869



ENERGY NOVA
2872



FLINT
0205

Alpinism-Ski Mountaineering



ALP RACE
3168



ALP CR
3169

Groups



TOPAZ II
3215



GROUP III
3216

Junior



ENERGY JR
2873



BAMBINO
0657



BAMBINO CHEST
0900

Chest harnesses



FIGURE 8 CHEST
0909

Technical features on VELOCITY harness

Our top-level sport climbing harness. Superlight, breathable, comfortable and packable.

Stainless steel auto-locking buckle on the waist



3D mesh for a high level of comfort and breathability



Differentiated color belay loop and reinforced tie-in points

Fixed leg loops for a performance fit

VELOCITY 3475

Innovative Smart Webbing Technology construction for excellent breathability, good load distribution, and great packability

Chalk bag loop



2 stitched loops for Hub racking carabiners



4 differentiated gear loops with preformed semi-rigid front loops and flexible rear loops

Additional fifth gear loop in the rear

Drop seat with fast-clip plastic buckles

Technical features on AURORA harness

Our top-level climbing harness designed specifically for women. Superlight, breathable, comfortable and packable.

Stainless steel auto-locking buckles on the waist and legs



3D mesh for a high level of comfort and breathability

Differentiated color belay loop and reinforced tie-in points

The waist belt features special construction that follows the contours of the hips for unparalleled support

Adjustable leg loops for a fine-tuned fit

Stainless steel auto-locking buckles on the waist and legs



AURORA 3476

Innovative Smart Webbing Technology construction for excellent breathability, good load distribution, and great packability

Chalk bag loop



2 stitched loops for Hub racking carabiners

4 differentiated gear loops with preformed semi-rigid front loops and flexible rear loops

Additional fifth gear loop in the rear



Drop seat with fast-clip plastic buckles



Available for men: Escape ref. 3474



VELOCITY

3475



NEW

LIGHT&FAST

ROCK CLIMBING, SPORT CLIMBING

- Our top-level sport climbing harness
- Innovative Smart Webbing Technology construction for excellent breathability, good load distribution, and great packability
- 3D mesh for a high level of comfort and breathability
- Stainless steel auto-locking buckle on the waist
- Fixed leg loops for a performance fit
- Differentiated color belay loop and reinforced tie-in points
- 4 differentiated gear loops with preformed semi-rigid front loops and flexible rear loops
- Additional fifth gear loop in the rear
- 2 stitched loops for Hub racking carabiners
- Chalk bag loop
- Drop seat with fast-clip plastic buckles

The Velocity is a top-level sport climbing harness that uses innovative Smart Webbing Technology construction with special webbing that integrates breathable material with full strength strands for excellent breathability, good load distribution, and great packability. The soft 3D mesh liner delivers a high level of comfort and breathability. The waist is adjusted with a secure stainless steel auto-locking buckle. Four differentiated gear loops with preformed semi-rigid front loops in the front and flexible loops in the rear. The additional fifth gear loop in the back is constructed from minimalist cord to be low profile. The differentiated color belay loop, drop seat with fast-clip buckles, two stitched loops for Hub racking carabiners and chalk bag loop round out the features on this high performance harness.

Ref.	Product name	Sizes	Weight Size (M)						No-Twist Belay Loop	Haul Loop	Drop Seat	Stitched loop for HUB racking carabiners	 EN 12277/C
			g	oz	B - Waist (cm / in)	C - Legs (cm / in)							
3475	VELOCITY	XS	270	9.5	62-72	24.4-28.3	48-52	18.9-20.5			•	2	•
		S			69-79	27.2-31.1	52-56	20.5-22					
		M			76-86	29.9-33.9	56-60	22-23.6					
		L			83-93	32.7-36.6	60-64	23.6-25.2					
		XL			90-100	35.4-39.4	64-68	25.2-26.8					



ESCAPE

3474



NEW

1ST CLASS

ALPINISM, ROCK CLIMBING, MULTI-PITCH CLIMBING

- A top-level climbing harness for rock climbing and alpinism
- Innovative Smart Webbing Technology construction for excellent breathability, good load distribution, and great packability
- 3D mesh for a high level of comfort and breathability
- Stainless steel auto-locking buckles on the waist and legs
- Adjustable leg loops for a fine-tuned fit
- Differentiated color belay loop and reinforced tie-in points
- 4 differentiated gear loops with preformed semi-rigid front loops and flexible rear loops
- Additional fifth gear loop in the rear
- 2 stitched loops for Hub racking carabiners
- Chalk bag loop
- Drop seat with fast-clip plastic buckles

The Escape is a top-level climbing harness for rock climbing and alpinism that uses innovative Smart Webbing Technology construction with special webbing that integrates breathable material with full strength strands for excellent breathability, good load distribution, and great packability. The soft 3D mesh liner delivers a high level of comfort and breathability and adjustable leg loops allow for a fine-tuned fit. The waist and legs are adjusted with secure stainless steel auto-locking buckles. Four differentiated gear loops with preformed semi-rigid front loops in the front and flexible loops in the rear. The additional fifth gear loop in the back is constructed from minimalist cord to be low profile. The differentiated color belay loop, drop seat with fast-clip buckles, two stitched loops for Hub racking carabiners and chalk bag loop round out the features on this highly technical harness.

Ref.	Product name	Sizes	Weight Size (M)						No-Twist Belay Loop	Haul Loop	Drop Seat	Stitched loop for HUB racking carabiners	 EN 12277/C
			g	oz	B - Waist (cm / in)	C - Legs (cm / in)							
3474	ESCAPE	S	305	10.8	69-79	27.2-31.1	50-60	19.7-23.6			•	2	•
		M			76-86	29.9-33.9	55-65	21.6-25.6					
		L			83-93	32.7-36.6	60-70	23.6-27.6					
		XL			90-100	35.4-39.4	65-75	25.6-29.5					

AURORA

3476

NEW

1ST CLASS

LADY

ALPINISM, ROCK CLIMBING, MULTI-PITCH CLIMBING



- Our top-level climbing harness designed specifically for women
- Innovative Smart Webbing Technology construction for excellent breathability, good load distribution, and great packability
- 3D mesh for a high level of comfort and breathability
- The waist belt features special construction that follows the contours of the hips for unparalleled support
- Stainless steel auto-locking buckles on the waist and legs
- Adjustable leg loops for a fine-tuned fit
- Differentiated color belay loop and reinforced tie-in points
- 4 differentiated gear loops with preformed semi-rigid front loops and flexible rear loops
- Additional fifth gear loop in the rear
- 2 stitched loops for Hub racking carabiners
- Chalk bag loop
- Drop seat with fast-clip plastic buckles



The Aurora is a top-level climbing harness designed specifically for women. It uses innovative Smart Webbing Technology construction with special webbing that integrates breathable material with full strength strands for excellent breathability, good load distribution, and great packability. The soft 3D mesh liner delivers a high level of comfort and breathability and adjustable leg loops allow for a fine-tuned fit. The waist belt features special construction that follows the contours of the hips for a more profiled fit and better support. The waist and legs are adjusted with secure stainless steel auto-locking buckles. Four differentiated gear loops with preformed semi-rigid front loops in the front and flexible loops in the rear. The additional fifth gear loop in the back is constructed from minimalist cord to be low profile. The differentiated color belay loop, drop seat with fast-clip buckles, two stitched loops for Hub racking carabiners and chalk bag loop round out the features on this highly technical harness.



Ref.	Product name	Sizes	Weight Size (M)		B - Waist (cm / in)		C - Legs (cm / in)		No-Twist Belay Loop	Haul Loop	Drop Seat	Stitched loop for HUB racking carabiners	CE EN 12277/C
			g	oz	B - Waist (cm / in)	C - Legs (cm / in)							
3476	AURORA	XS	300	10.6	58-68	22.8-26.8	47-57	18.5-22.4			•	2	•
		S			65-75	25.6-29.5	52-62	20.5-24.4					
		M			72-82	28.3-32.3	57-67	22.4-26.4					
		L			79-89	31.1-35	62-72	24.4-28.3					





ALPINE FLASH

2720

ALPINISM, ICE CLIMBING, HIGH ALTITUDE

- Hyperlight and compact harness for technical alpinism and ice climbing
- Innovative Load Webbing construction
- Integrated 3 mm padding on the waist and legs
- Auto-locking buckles on the waist and legs
- Elastic straps between the waist and legs are connected by a single buckle for an easy drop seat
- 5 gear loops: 4 on the sides and 1 on the back
- 4 integrated slots for Hub racking carabiners
- Chalk bag loop
- 5 sizes: XS - XL

The Alpine Flash builds on the amazing Flash harness with a purpose-built design for technical alpinism and ice climbing at the highest level. By incorporating innovative Load Webbing construction, we achieve a remarkable combination of properties including exceptional comfort, hyper lightweight and hydrophobia, exceptional packability and minimalist construction that minimizes the number of stitch points. Features for ice climbing and alpinism include 5 gear loops (4 on the sides and 1 on the back), 4 integrated slots for Hub racking carabiners and adjustable leg loops with auto-locking steel buckles. Available in 5 sizes from XS - XL.

Ref.	Product name	Sizes	Weight Size (M)						No-Twist Belay Loop	Haul Loop	Drop Seat	Stitched loop for HUB racking carabiners	 EN 12277/C
			g	oz	B - Waist (cm / in)	C - Legs (cm / in)							
2720	ALPINE FLASH	XS	300	10.6	64-74	25.2-29.1	47-57	18.5-22.4			•	4	•
		S			70-80	27.6-31.5	51-61	20.1-24.0					
		M			76-86	29.9-33.9	55-65	21.7-25.6					
		L			82-92	32.3-36.2	59-69	23.2-27.2					
		XL			88-98	34.7-38.6	63-73	24.8-28.7					

ENERGY CR 4

2871

ALPINISM, ROCK CLIMBING, MULTI-PITCH CLIMBING

- A versatile and highly adjustable harness for rock climbing at every level
- Thermo-formed padding on the waist and legs molds to the body for exceptional comfort
- 2 auto-locking buckles on the waist combine with adjustable leg loops for a broad fit range
- 4 webbing reinforced gear loops
- Haul loop

A versatile and highly adjustable harness designed for rock climbing at every level. The proven design of the Energy CR4 makes it a great choice for any kind of climbing from gym to sport to trad. The thermo-formed padding molds to the body for exceptional comfort. Adjustable leg loops and 2 buckles on the waist allow for a broad fit range. 4 webbing-reinforced gear loops and a haul loop round out the features on this versatile harness.



1 Grey

2 Red

Ref.	Product name	Sizes	Weight Size (M)		B - Waist (cm / in)		C - Legs (cm / in)		No-Twist Belay Loop	Haul Loop	Drop Seat	Stitched loop for HUB racking carabiners	CE EN 12277/C
			g	oz	62-82	24.4-32.3	46-56	18.1-22					
2871	ENERGY CR 4	XS-M	380	13.4	62-82	24.4-32.3	46-56	18.1-22		•			•
		M-XL			76-100	29.9-39.4	52-62	20.5-24.4					

ENERGY CR 4 PACK

2932

ALPINISM, ROCK CLIMBING, MULTI-PITCH CLIMBING

- Kit includes the Energy CR 4 harness (2871), Nimbus Lock (2927), Piu 2.0 belay device (086502) and the stylish Acqualong chalk bag (1370-12)
- Available in 2 sizes: S and L

The Energy CR 4 is a versatile and highly adjustable harness designed for rock climbing at every level. The proven design of the Energy CR 4 makes it a great choice for any kind of climbing from gym to sport to trad. The kit also includes our top-level Piu 2.0 belay device and Nimbus Lock carabiner for a high level of performance in the gym or at the crag.



Ref.	Product name	Sizes
2932	ENERGY CR 4 PACK - 2871-L1 / 2927 / 086502 / 1370-12	S
	ENERGY CR 4 PACK - 2871-S1 / 2927 / 086502 / 1370-12	L



ENERGY CR 3

2870

BEST SELLER

ALPINISM, ROCK CLIMBING, MULTI-PITCH CLIMBING

- A lightweight, versatile harness for rock climbing at every level
- Thermo-formed padding on the waist and legs molds to the body for exceptional comfort
- Auto-locking buckles on the waist and legs
- 4 webbing reinforced gear loops
- Haul loop

A lightweight and comfortable harness designed for rock climbing at every level. The versatile design of the Energy CR3 makes it a great choice for any kind of climbing from gym to sport to trad. The thermo-formed padding molds to the body for exceptional comfort. Adjustable leg loops allow for a fine-tuned fit. 4 webbing-reinforced gear loops and a haul loop round out the features on this sophisticated harness.

Ref.	Product name	Sizes	Weight Size (M)		B - Waist (cm / in)		C - Legs (cm / in)		No-Twist Belay Loop	Haul Loop	Drop Seat	Stitched loop for HUB racking carabiners	CE EN 12277/C
			g	oz									
2870	ENERGY CR 3	XS	375	13.2	58-68	22.8-26.8	39-49	15.3-19.3		•			•
		S			65-75	25.6-29.5	49-59	19.3-23.2					
		M			72-82	28.3-32.3	55-65	21.6-25.6					
		L			79-89	31.1-35	60-70	23.6-27.6					
		XL			86-96	33.9-37.8	65-75	25.6-29.5					

ENERGY CR 3 PACK

2961

ALPINISM, ROCK CLIMBING, MULTI-PITCH CLIMBING

- Kit includes the Energy CR 3 harness (2870), Nimbus Lock carabiner (2927) and Piu 2.0 belay device (086502)
- Available in 5 sizes from XS to XL

The Energy CR 3 is a comfortable, lightweight harness designed for rock climbing at every level. The proven design of the Energy CR 3 makes it a great choice for any kind of climbing from gym to sport to trad. The kit also includes our top-level Piu 2.0 belay device and Nimbus Lock HMS carabiner for a high level of performance in the gym or at the crag.



Ref.	Product name	Sizes
2961	ENERGY CR 3 PACK - 2870-XS1 / 2927 / 086502	XS
	ENERGY CR 3 PACK - 2870-S1 / 2927 / 086502	S
	ENERGY CR 3 PACK - 2870-M1 / 2927 / 086502	M
	ENERGY CR 3 PACK - 2870-L1 / 2927 / 086502	L
	ENERGY CR 3 PACK - 2870-XL1 / 2927 / 086502	XL



1 Blue

ENERGY

2869

ROCK CLIMBING

- A sophisticated and versatile rock climbing harness
- Thermoformed padding on the waist and legs molds to the body for exceptional comfort
- Fixed leg loops for a performance fit
- Auto-locking buckle on the waist
- 4 webbing-reinforced gear loops
- Haul loop

A lightweight and comfortable harness designed for rock climbing at every level. The simple design of the Energy makes it a great choice for any kind of climbing from gym to sport to trad. The thermoformed padding molds to the body for exceptional comfort. Fixed leg loops deliver a performance fit. Four webbing-reinforced gear loops and a haul loop round out the features on this striking harness.



ENERGY JR

2873

JUNIOR

ROCK CLIMBING

- The Energy CR3 designed specifically for children
- Thermoformed EVA padding on the waist and legs
- Auto-locking buckles on the waist and legs
- 2 molded gear loops
- Chalk bag loop

The Energy Junior is a full-featured harness that kids love to wear because it is just like what their parents are wearing. Thermoformed EVA padding on the waist and legs ensure a secure and comfortable fit. Auto-locking buckles on the waist and legs are easy to operate and two molded gear loops give junior climbers a chance to rack gear.

Ref.	Product name	Sizes	Weight Size (M)		B - Waist (cm / in)		C - Legs (cm / in)		No-Twist Belay Loop	Haul Loop	Drop Seat	Stitched loop for HUB racking carabiners	CE EN 12277/C
			g	oz	cm	in	cm	in					
2869	ENERGY	XS	305	10.8	58-68	22.8-26.8	45-53	17.7-20.9		•			•
		S			65-75	25.6-29.5	50-58	19.7-22.8					
		M			72-82	28.3-32.3	55-63	21.6-24.8					
		L			79-89	31.1-35	60-68	23.6-26.8					
		XL			86-96	33.9-37.8	65-73	25.6-28.7					
2873	ENERGY JR	One-size	280	9.9	48-60	18.9-23.6	38-48	15.0-18.9					•



ENERGY NOVA

2872

LADY

ALPINISM, ROCK CLIMBING, MULTI-PITCH CLIMBING

- A lightweight harness designed to deliver a high level of comfort and performance for women
- The waist features conical construction to follow the contours of the hips for unparalleled support
- Thermo-formed padding on the waist and legs molds to the body for exceptional comfort
- Auto-locking buckles on the waist and legs
- 4 webbing reinforced gear loops
- Haul loop

A lightweight and comfortable harness designed specifically for women. The versatile design of the Energy Nova makes it a great choice for any kind of rock climbing from gym to sport to trad. The thermo-formed padding molds to the body for exceptional comfort. The waist uses conical construction to follow the contours of the hips for unparalleled support. Adjustable leg loops allow for a fine-tuned fit. 4 webbing-reinforced gear loops and a haul loop round out the features on this high-performance harness.

Ref.	Product name	Sizes	Weight Size (M)		B - Waist (cm / in)		C - Legs (cm / in)		No-Twist Belay Loop	Haul Loop	Drop Seat	Stitched loop for HUB racking carabiners	CE EN 12277/C
			g	oz	cm	in	cm	in					
2872	ENERGY NOVA	XS	345	12.2	56-66	22-26	52-62	20.5-24.4		•			•
		S			63-73	24.8-28.7	56-66	22-26					
		M			70-80	27.6-31.5	60-70	23.6-27.6					
		L			77-87	30.3-34.2	64-74	25.2-29.1					

ENERGY NOVA PACK

2962

LADY

ALPINISM, ROCK CLIMBING, MULTI-PITCH CLIMBING

- Kit for women that includes the Energy Nova harness (2872), Nimbus Lock carabiner (292702) and Piu 2.0 belay device (086501)
- Available in 4 sizes from XS to L

The Energy Nova is our lightweight, form-fitting harness designed specifically for women. The versatile design of the Energy Nova makes it a great choice for any kind of rock climbing from gym to sport to trad. The kit also includes our top-level Piu 2.0 belay device and Nimbus Lock HMS carabiner for a high level of performance in the gym or at the crag.



Ref.	Product name	Sizes
2962	ENERGY NOVA PACK - 2872-XS1 / 292702 / 086501	XS
	ENERGY NOVA PACK - 2872-S1 / 292702 / 086501	S
	ENERGY NOVA PACK - 2872-M1 / 292702 / 086501	M
	ENERGY NOVA PACK - 2872-L1 / 292702 / 086501	L

FLINT 0205

PAT. PEND.

ALPINISM, ROCK CLIMBING, MULTI-PITCH CLIMBING

- Auto-locking buckles on the waist and legs
- Comfortable 6 mm EVA foam padding
- No-Twist belay loop
- Drop seat with plastic buckles
- 4 webbing reinforced gear loops and haul loop

The Flint has been a popular and welcome addition to price-point harnesses where it blows the competition away with a belay loop, robust materials and construction, and technical features that make it ready for any adventure. Use it for top roping in the gym one day and gunning trad routes in the mountains the next. With four webbing reinforced gear loops, adjustable leg loops, drop seat buckles, No-Twist belay loop and a haul loop, the Flint is ready for anything you plan to throw its way.



1 Black / Red



klettern
PREISTIPP

ALP RACE 3168

LIGHT&FAST SKI COMP



COMPETITIVE SKI MOUNTAINEERING, SKI MOUNTAINEERING

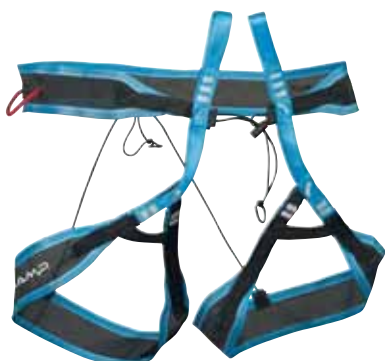

- The lightest harness in the world!
- Extremely compact, it folds down inside a special case to the size of a wallet
- Innovative construction uses nylon monofilament and high strength UHMW polyethylene (Ultra High Molecular Weight Polyethylene)
- Adjustable waist belt with elastic cord
- Elastic straps that connect the waist and legs are adjustable with elastic cord
- Hypalon® cord adjustments for exceptional durability
- High strength UHMW polyethylene tie-in points
- Hypalon® slots for removable gear loop
- Super breathable

The Alp Race is the reference for ski mountaineering competitions. At 68 grams, it breaks all the records and the packability is even more impressive. Folded into its own special case, it packs down to the size of a wallet. The innovative construction uses super light and breathable nylon monofilament combined with exceptionally durable and abrasion-resistant high strength polyethylene. An elastic cord on the waist belt is adjustable with a durable Hypalon® clip. The elastic rise adjustment cord for the leg loops is secured by a knot to prevent the leg loops from creeping down during dynamic movements. A single gear loop is removable using Hypalon® slots.



Video



Ref.	Product name	Sizes	Weight Size (M)						No-Twist Belay Loop	Haul Loop	Drop Seat	Stitched loop for HUB racking carabiners	CE EN 12277/C
			g	oz	B - Waist (cm / in)	C - Legs (cm / in)							
0205	FLINT	S	460	16.2	65-77	25.6-30.3	52-62	20.5-24.4	•	•	•		•
		M			75-87	29.5-34.3	56-66	22.1-26.0					
		L			85-97	33.5-38.2	60-70	23.6-27.6					
3168	ALP RACE	S	68	2.4	78-88	30.7-34.7	53-58	20.9-22.8					•
		M			85-95	33.4-37.4	58-63	22.8-24.8					
		L			92-102	36.2-40.1	63-68	24.8-26.8					
		XL			99-109	39-43	68-73	26.8-28.7					

ALP CR

3169

1ST CLASS

SKI MOUNTAINEERING, ALPINISM, HIGH ALTITUDE





Video



- Super light and compact harness for ski mountaineering and lightweight mountaineering
- All-mountain functionality allows the harness to be put on and taken off without removing skis or crampons
- Innovative construction uses nylon monofilament and high strength UHMW polyethylene (Ultra High Molecular Weight Polyethylene)
- Adjustable waist belt with elastic cord
- Elastic straps that connect the waist and legs are adjustable with elastic cord
- Hypalon® cord adjustments for exceptional durability
- High strength UHMW polyethylene tie-in points
- Adjustable leg loops with 7075 T6 aluminum alloy buckles
- The attachment point on the back of the leg loop for connecting the waist and legs can be used to hold the tip of an ice screw to prevent it from moving around and damaging pants
- Hypalon® slots for removable gear loops can also accommodate Hub racking carabiners
- Super breathable

The Alp CR is a hyperlight harness designed for ski mountaineering and lightweight mountaineering. The innovative construction uses super light and breathable nylon monofilament combined with exceptionally durable and abrasion-resistant high strength polyethylene. Adjustable leg loops ensure a precise fit and allow the harness to adapt to layers. The harness can be put on and taken off without removing skis or crampons. The elastic cord on the waist is detachable and the auto-locking aluminum alloy buckles on the leg loops can be unthreaded so they open completely. The elastic rise adjustment cord for the leg loops is secured by a knot to prevent the leg loops from creeping down. Two gear loops are removable using Hypalon® slots that can also accommodate Hub racking carabiners for ice screws.

Ref.	Product name	Sizes	Weight Size (M)						Drop seat	 EN 12277/C
			g	oz	B - Waist (cm / in)		C - Legs (cm / in)			
3169	ALP CR	S	94	3.3	78-88	30.7-34.7	55-65	21.6-25.6	•	•
		M			85-95	33.4-37.4	60-70	23.6-27.6		
		L			92-102	36.2-40.1	65-75	25.6-29.5		



TOPAZ II 3215

ROPE COURSES & INSTITUTIONAL, VIA FERRATA, CLIMBING GYMS

- One size fits all with a very wide adjustment range
- Waist belt features the exclusive Special FIT System to adapt to a wide size range
- Sliding waistband and leg loops can be centered for optimal comfort
- 6 mm expanded EVA foam padding with a soft, breathable mesh inner lining
- Auto-locking steel buckles are quick and easy to adjust
- Differentiated color leg loops for easy identification
- Single front attachment point is reinforced for frequent use
- 2 reinforced gear loops and a loop for connecting a chalk bag



Video

The Topaz II uses construction similar to the Group III for a very wide adjustment range, but is built out with padding and other features that make it more comfortable and functional for actual climbing. The exclusive Special FIT System changes the size of the padding for small and big users. Keep the webbing inside the Special FIT System for bigger users so the padding wraps around more of the body. Remove the webbing from the Special FIT System for smaller users so the size can be adjusted down. The padding on both the waist belt and leg loops can slide so it can be centered for optimal comfort independent of size. The single front attachment point is fully reinforced for extra abrasion resistance and frequent use. The buckles are auto-locking for safety and profiled for quick and easy adjustment. The Topaz II is a premium institutional harness designed for adventure parks and rentals where comfort can play a big part in the enjoyment of the activities, and for via ferrata courses where users can feel like they are in a true technical harness designed for climbing.



GROUP III 3216

ROPE COURSES & INSTITUTIONAL

- One size fits all with a very wide adjustment range
- Constructed from 45 mm tapered webbing for intensive use
- Auto-locking steel buckles are quick and easy to adjust
- Differentiated color leg loops for easy identification
- Single front attachment point is reinforced for frequent use
- Single reinforced gear loop
- Compact design for easy storage and transport



Video

The Group III is an extremely robust webbing harness with a single front attachment point that is fully reinforced for extra abrasion resistance. The buckles are auto-locking for safety and profiled for quick and easy adjustment. The leg loops are different colors for easy identification, and the simple webbing construction offers a huge range of adjustment to fit users of almost any size making it ideal for adventure parks and rentals.



8 Black

FIGURE 8 CHEST 0909

ALPINISM, VIA FERRATA, ROPE COURSES & INSTITUTIONAL, CAVING

- Wide 45 mm webbing for comfort
- One size fits most

Many climbers rig a chest harness from webbing, but these are difficult to adjust as layers change and the carabiner is likely to smack them in the face during a fall. The Figure 8 chest harness is superior to any rigged chest harness. The buckles are located under the arms where they are out of the way of pack shoulder straps. Use a locking carabiner to clip the chest harness to the rope that is tied into the sit harness.

Ref.	Product name	Sizes	Weight		A - Chest (cm / in)		B - Waist (cm / in)		C - Legs (cm / in)		CE	
			g	oz							EN 12277/C	EN 12277/D
3215	TOPAZ II	One-size	620	21.9			60-110	23.6-43.3	38-70	15-27.6	•	
3216	GROUP III	One-size	390	13.8			50-110	19.7-43.3	30-70	11.8-27.6	•	
0909	FIG. 8 CHEST	XS-L	290	10.2	61-110	24.0-43.3						•



BAMBINO

0657

JUNIOR

ROCK CLIMBING, ROPE COURSES & INSTITUTIONAL

- Pre-Threaded Auto-Locking Buckles
- One size fits all
- Recommended for children 3 to 8 years old not exceeding 85 lbs.

Climbing is a fantastic activity for young kids! Start them early but keep them safe with the Bambino full-body harness. Six points of adjustment allow the harness to be fine-tuned for a wide range of body styles and sizes. A single tie-in point at the sternum keeps the child positioned upright while hanging. The pre-threaded auto-locking buckles are quick, safe and easy to adjust and elastic retainers keep fidgeting fingers from loosening things when you aren't looking. Color-coding on the leg loops, waist belt and tie-in point make fitting the Bambino a breeze and further reduce the potential for user error.



BAMBINO CHEST

0900

JUNIOR

ROCK CLIMBING

- Pre-Threaded Auto-Locking Buckles
- For children up to 85 lbs.

Kids have more mass in their upper bodies so they can flip upside down during a free fall while wearing a sit harness, increasing the chance of hitting their head or slipping out of the harness when inverted. Therefore, it is important for young children to wear a chest harness while lead climbing and rappelling. A chest harness is only designed for use with a certified sit harness and can NEVER be worn alone!

Ref.	Product name	Sizes	Weight		CE					
			g	oz	B - Waist (cm / in)	A - Chest (cm / in)	C - Legs (cm / in)	EN 12277/B	EN 12277/C	EN 12277/D
0657	BAMBINO	One-size	370	13.1		50-85 19.7-33.5	30-60 11.8-23.6	•		
0900	BAMBINO CHEST	One-size	160	5.6		61-70 24.0-27.6				•

CHALK BAGS & CHALK



Whose forearm is this? Stefano Ghisolfi chinks before going ahead on "Move Hard" (9b) in Flatanger, Norway © Diego Borello

CHALK BAGS & CHALK

Chalk Bags



POLIMAGO
3087



PATABANG
1376



ACQUALONG
1370



OMEGA
3401

NEW



KAPPA
3427

NEW

Chalk



VELVET CHALK
3110



CHUNKY CHALK
3111



BLOCK CHALK
311201



CHALK POUCH
3113



RE-CHALK
3114



LIQUID CHALK
311501



LIQUID CHALK + ROSIN
311502



CLIMBING TAPE
3116



BAMBOO BRUSH
3117



308701

308702



308703

308704

POLIMAGO

- 308701 Hipster
- 308702 Psychedelic
- 308703 Cheshire Cat
- 308704 Pop Corn

ROCK CLIMBING, SPORT CLIMBING, BOULDERING

- Flat bottom allows the chalk bag to stand upright
- Stiffened rim creates a wide opening while climbing
- Dual belt loop attachment points; delivered with a 15 mm webbing belt with fast-clip buckle
- Webbing brush holder
- Polyester fabric with 4 color combinations and the exclusive Chalkemy patch

The Polimago is an excellent choice for a wide variety of climbing styles, including bouldering where the bag is designed to stand upright when set on the ground to help reduce chalk spillage. Constructed from polyester fabric. Available in four striking color combinations with the exclusive Chalkemy patch.

POLIMAGO PACKAGE 8 pcs

3088



12 Grey / Green

13 Grey / Blue



14 Red / Blue

15 Green

ACQUALONG

1370

ROCK CLIMBING, SPORT CLIMBING, BOULDERING

- Flat bottom allows the chalk bag to stand upright
- Stiffened rim creates a wide opening while climbing
- Tight closure prevents chalk leaking
- Dual belt loop attachment points; delivered with a 15 mm webbing belt with fast-clip buckle
- Webbing brush holder
- Nylon fabric with 4 color combinations and the exclusive Chalkemy printing are coordinated with Energy harnesses

The Acqualong features our most traditional cut with a flat bottom and round design that makes it a great cross-over for bouldering and rope climbing. Constructed from bright nylon fabric. Available in four striking color combinations with the exclusive Chalkemy patch.

ACQUALONG PACKAGE 8 pcs

3071



3 Green / Dark Blue

4 Grey / Green

PATABANG

1376

ROCK CLIMBING, SPORT CLIMBING, MULTI-PITCH CLIMBING

- Ergonomic design with a large, bellowed bottom
- Easily swallows an entire block of chalk and taped hands
- Stiffened rim creates a wide opening while climbing
- Tight closure prevents chalk leaking
- Dual belt loop attachment points; delivered with a 15 mm webbing belt with fast-clip buckle
- Elastic brush keeper
- Burlly nylon fabric with 2 color combinations and the exclusive Chalkemy patch

The Patabang is the best choice for traditional rock climbing as its larger capacity allows you to carry more chalk than smaller bags and fits big hands made even bigger with tape gloves. Constructed from burly nylon fabric. Available in two color combinations with the exclusive Chalkemy patch.

Ref.	Product name	Weight		Capacity	With belt
		g	oz	L	
3087	POLIMAGO	90	3.2	1.3	•
1370	ACQUALONG	90	3.2	1	•
1376	PATABANG	100	3.5	1.9	•



OMEGA

3401

NEW

ROCK CLIMBING, SPORT CLIMBING, MULTI-PITCH CLIMBING

- Ergonomic design with large capacity and big opening
- Easy to use for large and taped hands
- Tight closure prevents chalk leaking
- Dual belt loop attachment points with a 15 mm webbing belt (included)
- Zippered pocket for phone and accessories
- Elastic brush keeper loop
- Burly nylon fabric with the exclusive Chalkemy patch

The Omega chalk bag is very large to be able to accommodate more chalk and fit bigger hands than other chalk bags. The zippered accessory pocket and large capacity make it a great choice for multi-pitch routes or for keeping valuables like your phone or wallet close and accessible while climbing.



KAPPA

3427

NEW

ROCK CLIMBING, SPORT CLIMBING, BOULDERING, MULTI-PITCH CLIMBING

- Leak proof storage bag for carrying extra chalk or for carrying a chalk bag so it does not leak chalk during transport
- Taped seams and secure roll-top closure with a rigid edge and secure buckle create a leak proof seal

The Kappa is a leak proof storage bag for carrying extra chalk or for carrying your chalk bag during transport so it does not leak chalk inside your pack. Taped seams and a secure roll-top closure with a rigid edge for folding and a secure buckle create a leak proof seal.

Ref.	Product name	Weight		Capacity	With belt
		g	oz	L	
3401	OMEGA	112	4.0	1.5	•
3427	KAPPA	33	1.2	2	

CHALKEMY: CHALK+ALCHEMY

A Premium Chalk Selection of high quality, finely curated magnesium carbonate ($4Mg CO_3 Mg(OH)_2 5H_2O$). Raw material comes from minerals with the lowest levels of harmful or toxic elements. Product manufacturing is implemented in Europe using the latest technology for purity and sustainability.

Why do we use chalk? Because it enhances our performance. It is essential to pushing our limits. The combination of all the elements aligning at the right moment is the alchemy we are all questing for as climbers. Everything must be right. Top level performance and the best experiences come in that moment when we combine the right chalk, the right rubber, and the right gear with the right fitness, experience, people, places, and conditions. From fine powder to crushed chunks, compacted blocks, balls & pouches, and liquid, the Chalkemy range allows climbers to tune their chalk to their climbing for maximum grip. A small amount of rosin is added to our Liquid + Rosin to deliver the best possible grip. Rosin, also called colophony, is a natural resin from trees.

Each type of chalk has peculiar features which make it more or less suitable for different kinds of climbing. These features are the powder grade (how fine the chalk is), the staying power (how long the chalk stays on your hands), and the readiness (how quickly the chalk covers your hands). Each product is distinguished by a different combination of these features in the 'Chalkemy Index' where each feature is ranked from 1 to 5. Velvet Chalk, for example, has a very high powder grade (5), an equally high readiness (5), and a lower staying power (2). The index is designed to help climbers find the right chalk for their specific needs.

CHALKEMY INDEX	POWDER GRADE	How fine the chalk is
	STAYING POWER	How long the chalk stays on your hands
	READINESS	How quickly the chalk covers your hands



VELVET CHALK

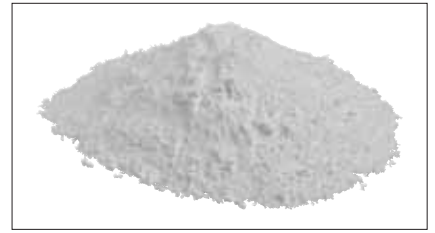

CHUNKY CHALK



BLOCK CHALK



LIQUID CHALK



CHALKEMY SELECTION



VELVET CHALK



CHUNKY CHALK

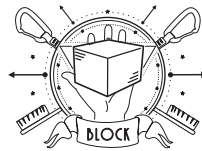

BLOCK CHALK



CHALK POUCH



RE - CHALK



LIQUID CHALK

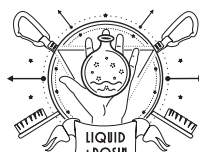

LIQUID CHALK + ROSIN

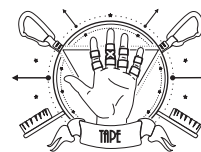

TAPE

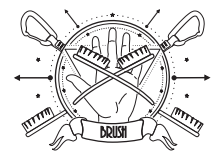

BRUSH



311001



311002

VELVET CHALK

311001 200 g

311002 450 g

1ST CLASS

ROCK CLIMBING, BOULDERING, SPORT CLIMBING

- Premium chalk in a very fine powder
- Packed in a resealable bag
- Available in 2 sizes: 200 g, 450 g

Premium chalk in a very fine powder delivers a uniform coating for precision climbing. The fine consistency sticks to the skin for fast chalking action with complete coverage making it ideal for hard climbing.

CHALKEMY INDEX	POWDER GRADE	●●●●●
	STAYING POWER	●●○○○
	READINESS	●●●●●



311101



311102

CHUNKY CHALK

311101 120 g

311102 450 g

BEST SELLER

311103 650 g

311104 10 kg

311105 20 kg

SPORT CLIMBING, MULTI-PITCH CLIMBING, ROCK CLIMBING

- Premium chalk crushed and ready for use
- Packed in a resealable bag or bucket
- Bag available in 2 sizes: 120 g, 450 g
- Bucket available in 3 sizes: 650 g, 10 kg, 20 kg

Premium chalk crushed and ready for use. Long-lasting staying power makes it the right choice for route climbing and everyday use.

CHALKEMY INDEX	POWDER GRADE	●●○○○
	STAYING POWER	●●●●●
	READINESS	●●●○○



311103



311104 / 311105

Ref.	Product name	Weight		Grind	Pack
		g	oz		
311001	VELVET CHALK 200 g	200	7.1	Fine	Resealable bag
311002	VELVET CHALK 450 g	450	15.9	Fine	Resealable bag
311101	CHUNKY CHALK 120 g	120	4.2	Coarse	Resealable bag
311102	CHUNKY CHALK 450 g	450	15.9	Coarse	Resealable bag
311103	CHUNKY CHALK 650 g	650	22.9	Coarse	Bucket
311104	CHUNKY CHALK 10 kg	10000	353.0	Coarse	Bucket
311105	CHUNKY CHALK 20 kg	20000	706.0	Coarse	Bucket



BLOCK CHALK

311201 120 g

BEST SELLER

ROCK CLIMBING, BOULDERING, MULTI-PITCH CLIMBING, SPORT CLIMBING

- Premium chalk in a compacted block
- Blocks are pressed into tabs for easy dosing
- 120 g blocks are packed in boxes of 18

Compacted block chalk pressed into tabs for easy dosing. Tabs are ideal to mark holds and 120 grams is more than double the amount of chalk in a standard block.

CHALKEMY INDEX	POWDER GRADE	●●●○○
	STAYING POWER	●●●○○
	READINESS	●●○○○



CHALK POUCH

3113 65 g

CLIMBING GYMS

- Non-refillable chalk pouch filled with premium loose chalk
- Mesh pouch contains 65 g of chalk

Non-refillable chalk pouch filled with 65 grams of premium loose chalk. Packed in a mesh net, it is the right solution for keeping chalk pollution to a minimum. Ideal for climbing gyms and home walls.

CHALKEMY INDEX	POWDER GRADE	●●●●●
	STAYING POWER	●●●○○
	READINESS	●●●○○

Ref.	Product name	Weight		Grind	Pack
		g	oz		
311201	BLOCK CHALK 120 g	120	4.2	Pressed tabs	Block
3113	CHALK POUCH 65 g	65	2.3	Fine	Mesh net



RE-CHALK

3114 75 g

CLIMBING GYMS

- Refillable chalk pouch filled with premium loose chalk
- Mesh pouch contains 75 g of chalk

Refillable chalk pouch filled with 75 grams of premium loose chalk. Packed in a mesh net, it is the right solution for keeping chalk pollution to a minimum. Ideal for climbing gyms and home walls.

CHALKEMY INDEX	POWDER GRADE	●●●●●
	STAYING POWER	●●●○○
	READINESS	●●●○○



LIQUID CHALK

311501 150 ml

CLIMBING GYMS, BOULDERING, SPORT CLIMBING

- Liquid chalk
- Fast drying with an alcohol base (>70%)
- 150 ml bottles are packed in boxes of 18

Premium liquid chalk with a fast-drying alcohol base (>70%) creates a great chalk base for sustained climbing. Ideal for climbing gyms and performance climbing outdoors.

CHALKEMY INDEX	POWDER GRADE	●○○○○
	STAYING POWER	●●●●●
	READINESS	●○○○○



LIQUID CHALK + ROSIN

311502 150 ml

CLIMBING GYMS, BOULDERING, SPORT CLIMBING

- Liquid chalk with rosin additive
- Fast drying with an alcohol base (>70%)
- 150 ml bottles are packed in boxes of 18

Fast drying alcohol-based (>70%) liquid chalk that creates a great chalk base for sustained climbing. Rosin additive for extra grip. Ideal for gyms, competitions and humid conditions.

CHALKEMY INDEX	POWDER GRADE	●○○○○
	STAYING POWER	●●●●●
	READINESS	●○○○○



Ref.	Product name	Weight		Grind	Pack
		g	oz		
3114	RE-CHALK 75 g	75	2.6	Fine	Refillable bag
311501	LIQUID CHALK 150 ml	150	5.3	Liquid	Bottle
311502	LIQUID CHALK + ROSIN 150 ml	150	5.3	Liquid	Bottle



CLIMBING TAPE

311601 66 g - Yellow

311602 66 g - Red

311603 66 g - Blue

311604 66 g - White

SPORT CLIMBING, BOULDERING, CLIMBING GYMS

- Climbing tape for skin care and tendon support
- 3.8 cm x 10 m
- Available in 4 colors: yellow, red, blue and white

Strong and durable tape for skin care and tendon support. Preventive taping has become a best practice for training sessions and hard sends.



BAMBOO BRUSH

3117 15 g

SPORT CLIMBING, BOULDERING

- Natural bristle brush with bamboo handle

Features stiff natural bristles and an ergonomic bamboo handle to make cleaning holds quick and easy.



BOULDERING



Stefano Ghisolfi trying the most difficult boulder problem in the world, "Burden of Dreams" (9A) in Finland © Sara Crippa

BOULDERING

UIAA Crash Pad Certifications

The UIAA 161 standard specifies safety requirements and test methods for crash pads used in bouldering. Each model is tested by following a defined procedure to determine the critical fall height, defined as the maximum free height of a fall from the top of the crash pad to the lowest part of the climber, for which the crash pad will provide an acceptable level of impact attenuation. The standard helps climbers understand the safety margins of any given crash pad using an objective testing methodology.



MINIDO

3390

NEW BEST SELLER

BOULDERING

- Compact and affordable crash pad
- Burly Tri-Ripstop 600D fabric with an internal coating for tensile strength and weather resistance
- 4 inches (10.5 cm) of padding comprised of 3 different foam densities
- Strong aluminum buckles
- Hypalon® reinforcements on the corners for extra durability
- Ergonomic shoulder straps with Velcro attachment for easy removal
- Soft webbing waist belt with fast buckles for better comfort and support while walking
- UIAA 161 certified (2.20 m critical falling height)

A crash pad that follows in the footsteps of the popular Domino with burly materials and high-quality construction; but with a smaller footprint and a lower price tag. With its compact footprint, the Minido fits easily in small cars, but still delivers a soft landing with 4 inches (10.5 cm) of padding comprised of 3 different foam densities. Updated for 2024 with a diagonal fold to eliminate the break in padding when laid flat and Hypalon® reinforcements on the corners for extra durability. Zippers allow access to the padding so it can be ventilated for drying or removed to wash the shell. The exterior is Tri-Ripstop 600D nylon fabric with an internal coating to increase the tensile strength of the fabric and block moisture and dirt from reaching the foam. Modular shoulder straps allow the Minido to be carried as a backpack, over one shoulder like a messenger bag, or as a brief case with two large, comfortable handles. The closure straps are long enough to wrap around large loads carried inside the pad. Soft webbing waist belt with fast buckles for better comfort and support while walking.

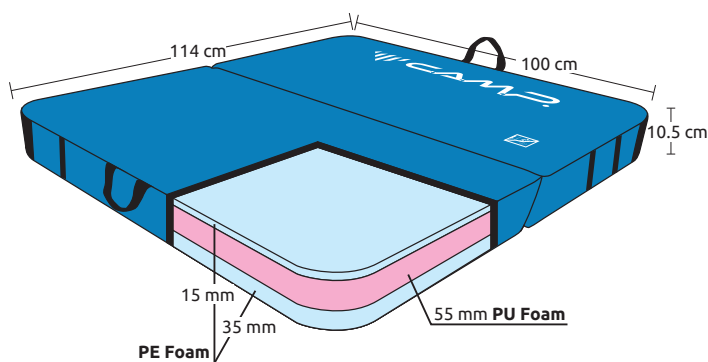

Ref.	Product name	Weight		UIAA 161
		g	oz	
3390	MINIDO	4250	150.0	•

DOMINO

3361

1ST CLASS

BOULDERING

- 5.3 inches (13.5 cm) of padding is made up of 5 layers for optimal energy absorption
- Hypalon® reinforcements on primary wear points and corners maximize durability
- Ergonomic shoulder straps with Velcro attachment for easy removal
- Soft webbing belt with fast buckle for greater comfort and support while walking
- Straps allow the crash pad to be converted into a sofa
- UIAA 161 certified (2.75 m critical falling height)

The extra-thick padding (5.3 inches made up of 5 multi-density layers) with a diagonal fold provides solid, uniform landings on uneven terrain. The rugged fabric and Hypalon® reinforcements on the corners and straps guarantee strength, prevent tears, and limit stretching in the exact places where other pads tend to fail. Join together as many Dominos as you have access to for a large landing area that acts as a solid single unit when linked in coordination with the dots on the pads. The dots also serve as a catchy technical solution to highlight the optimal landing zone. The side straps are extendable and can be connected to the sides to convert the Domino into a sofa for luxury lounging. The shoulder straps are modular and allow the pad to be carried as a backpack (even features attachment points for lashing two pads together for the approach), over one shoulder like a messenger bag, or as a suitcase.

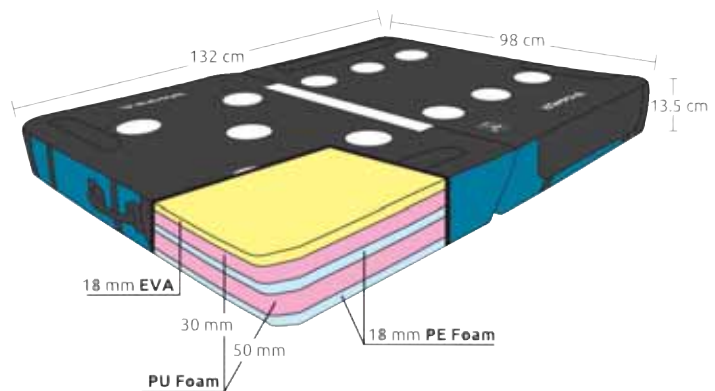

BOULDERING

Ref.	Product name	Weight		UIAA
		g	oz	
3361	DOMINO	6650	234.7	161



GAMMA

3402

NEW

BOULDERING

- High capacity chalk pot for bouldering
- Large opening makes it easy to chalk both hands at the same time
- Secure roll-top closure with buckles and Velcro prevents leaking during transport
- Compact design carries well inside a crash pad
- Constructed from strong and durable ripstop fabric
- 2 zippered elastic outer pockets for valuables and accessories
- 3 elastic brush keeper loops

The Gamma is a high capacity chalk pot with all the features for a full day at the boulders. The opening is large enough to chalk both hands at the same time. Constructed from the same fabric as the Domino crash pad for exceptional strength and durability. The roll-top closure system with buckles and Velcro seals the opening to prevent chalk from leaking during transport. Two zippered elastic outer pockets for carrying valuables and accessories and three elastic loops for brushes.

Ref.	Product name	Capacity	Weight	
			g	oz
3402	GAMMA	5 L	325	11.5

HELMETS



Luka Lindič on "Travels with Charlie" (175 m, 5.12a), the new route opened with Ines Papert in the Ghost River Range, Canada © Michael Klekamp

HELMETS

Climbing and mountaineering helmet standards

In climbing and mountaineering it is always highly recommended to wear a helmet. To ensure appropriate protection, helmets are subjected to laboratory tests that ensure their compliance with a standard. Standards guarantee a level of protection that adequately protects the user from the risks of the activity performed. Helmets for climbing and mountaineering must be compliant with the EN 12492 standard. This standard is primarily designed as a function of the risk of falling objects from above like rock fragments or pieces of ice. The tests evaluate both the ability of the helmet to absorb the impact of a mass that hits it on the upper two thirds of the shell and its resistance to the penetration of a pointed mass (60° cone) at its vertex. The tests are carried out by mounting the helmet on a dummy head form and dropping the masses onto the helmet.



Side impact protection

Helmets absorb and disperse energy before it is transmitted to the head primarily using EPS foam that deforms on impact. The Storm and Speed Comp helmets are notable for their full protection with EPS foam covering every part of the head that is covered by the helmet. Molded EPS foam helmets are the safest climbing helmets due to their ability to absorb energy anywhere they are struck.



Ski mountaineering helmets

In ski mountaineering, the helmet serves the same function as a traditional alpine ski helmet which is designed absorb impacts from a fall. In the event of a fall, the skiers' head undergoes a sudden deceleration. For this reason, the tests for the standards related to alpine ski helmets do not measure impact force, but deceleration. There are also additional parts of the standard related to penetration of objects like ski and pole tips. This is why alpine ski helmets are generally not particularly well ventilated. Ski mountaineering is a complex blend of alpine skiing and mountaineering and this is why the helmet must comply with both the ski helmet standard EN 1077 and the mountaineering helmet standard EN 12492.



CATEGORY LEADERS



LIGHT&FAST 1ST CLASS BEST SELLER

STORM
2457



1ST CLASS

SPEED COMP
2458

For the EN 1077 standard, the deceleration is measured by dropping the helmet with a dummy head form onto a flat surface. The standard has two different classifications: class A and class B. Class A helmets fully cover the head and ears and are intended primarily for downhill only skiers who need both mechanical and thermal protection. Class B helmets leave the ears uncovered so they do not inhibit hearing and can have better ventilation. The ski mountaineering activity requires the helmet to meet both the EN 1077/B and the EN 12492 standard so it can protect the user from all of the elements that are part of the activity. Helmets that do not meet both standards are not certified for use in ISMF sanctioned ski mountaineering races.

The Speed Comp and the Voyager helmets are two of the few helmets on the market that meet both standards. Through multiple rounds of R&D, C.A.M.P. designed two helmets that meet the standards while maintaining a performance fit and enough ventilation to be able to go hard in the mountains.

Ref.	Product name	Sizes		Weight		Construction	Shell material	CE	
				g	oz			EN 12492	EN 1077/B
2457	STORM	48-56 cm	18.9-22 in	230	8.1	In-mold	Polycarbonate	•	
		54-62 cm	21.3-24.4 in	250	8.8				
212701	TITAN - Small	48-56 cm	18.9-22 in	385	13.6	Hard shell	ABS	•	
212702	TITAN - Large	54-62 cm	21.3-24.4 in	435	15.4	Hard shell	ABS	•	
2595	ARMOUR	50-57 cm	19.7-22.4 in	315	11.1	Hard shell	ABS	•	
		54-62 cm	21.3-24.4 in	370	13.1				
0202	ROCKSTAR	53-62 cm	20.9-24.4 in	400	14.1	Hard shell	Polypropylene	•	
2458	SPEED COMP	54-60 cm	21.3-23.6 in	350	12.4	In-mold	Polycarbonate	•	•
3283	VOYAGER	54-58 cm	21.3-22.8 in	465	16.4	Hard shell + In-mold	ABS + Polycarbonate	•	•
		57-62 cm	22.4-24.4 in	475	16.8				

HELMETS

Helmets



STORM
2457



TITAN
212701/212702



ARMOUR
2595



ROCKSTAR
0202



SPEED COMP
2458



VOYAGER
3283

STORM

2457

LIGHT&FAST

1ST CLASS

BEST SELLER

ALPINISM, ROCK CLIMBING, MULTI-PITCH CLIMBING



9 Grey / Lime



- Our lightest helmet designed for technical climbing and mountaineering
- In-mold EPS construction with a durable polycarbonate shell
- Open air design with 22 vent holes for remarkable breathability
- Precise fit with removable padding for exceptional comfort and safety
- Lightweight and secure dial adjustment system sits low on the head to keep the helmet in position
- Quick adjust locking buckles on both sides of the chin strap for easy and secure adjustment
- Headlamp compatible
- Available in 2 sizes and in 6 colors
- EN 12492 certified

The Storm is a cutting-edge helmet that provides exceptional protection and is comfortable enough to wear all day in any conditions and for any kind of climbing. 22 streamlined vents keep the head cool on multi-pitch climbs and when conditions warm up on mountaineering routes. Two sizes have been optimized for a very broad fit range and the harness and dial system cradle the head low to keep the helmet in position even with dynamic movements.



5 Light Blue



6 Grey



7 White



8 Red



10 Light Blue / Fuchsia



Video

TITAN

212701 Small

212702 Large

ALPINISM, ROCK CLIMBING, VIA FERRATA, ROPE COURSES & INSTITUTIONAL



1 Red

- Durable ABS injection molded shell
- Spider suspension framework with EPS foam in the upper part for exceptional comfort and ventilation
- Assembled without rivets or screws
- Fast and easy to disassemble for washing and cleaning
- 4 burly headlamp holder clips
- Strong and durable size adjustment wheel
- Available in 2 sizes and in 4 colors
- EN 12492 certified

The Titan blends strength, durability, comfort, and a striking aesthetic unlike any other helmet. It is an authentic workhorse with an ABS injection molded shell that is specially shaped to optimize strength and durability. Assembly is done without the use of fixed components which means it can be disassembled for easy cleaning and maintenance. This is particularly useful for adventure parks and guiding outfits who can replace the liners as they get contaminated over time. The spider suspension framework combines with EPS foam in the upper part for a precise fit and exceptional comfort and ventilation. Comfort is enhanced even further with soft, breathable, absorbent padding that keeps everything feeling dry and light during use. The dial adjustment system is beefed up to handle heavy use and four strong clips hold a head lamp securely in place.



2 Grey



3 White



4 Green

Ref.	Product name	Sizes		Weight		Construction	Shell material	CE	
				g	oz			EN 12492	EN 1077/B
2457	STORM	48-56 cm	18.9-22 in	230	8.1	In-mold	Polycarbonate	•	
		54-62 cm	21.3-24.4 in	250	8.8				
212701	TITAN - Small	48-56 cm	18.9-22 in	385	13.6	Hard shell	ABS	•	
212702	TITAN - Large	54-62 cm	21.3-24.4 in	435	15.4	Hard shell	ABS	•	



ARMOUR

2595

ALPINISM, ROCK CLIMBING, VIA FERRATA

- Hybrid construction with fit profile for a wide range of head shapes and sizes
- Durable and easy-to-use rotating size adjustment wheel
- Side holes for ventilation
- 4 burly headlamp holder clips
- Available in 2 sizes and in 4 colors/designs for each size
- EN 12492 certified

The Armour helmet is a hybrid helmet with an ABS hard shell and profiled interior for a secure and comfortable fit. Available in two sizes with four colors/designs for each size. Easy-to-use adjustment wheel on the back and multiple points for adjusting the straps to fine tune the fit. Ventilation slots on the sides for breathability and four strong clips for a secure attachment of a headlamp.



S1 White / Red



S2 White / Light Blue



S3 Opal Green



S4 Orange



L1 White / Red



L2 Lime / Green



L3 Grey



L4 Red



Ref.	Product name	Sizes		Weight		Construction	Shell material	CE	
				g	oz			EN 12492	EN 1077/B
2595	ARMOUR	50-57 cm	19.7-22.4 in	315	11.1	Hard shell	ABS	•	
		54-62 cm	21.3-24.4 in	370	13.1				

ROCKSTAR

0202

ROCK CLIMBING, VIA FERRATA, ALPINISM, ROPE COURSES & INSTITUTIONAL



9 Light Blue



11 Orange



8 Red



10 White

- Hybrid construction
- Slider size adjustment
- Comfort chin strap
- Headlamp compatible
- EN 12492 certified

This versatile and affordable helmet is perfect for large groups and rental programs where helmets are bound to get beat up. The durable injection-molded polypropylene shell has 4 side vents. A replaceable polyethylene inner suspension cradle offers fast and easy slide adjustment and is covered with fast-drying material for comfort.



2 Black



1 Light Blue



3 White

SPEED COMP

2458

1ST CLASS SKI COMP



COMPETITIVE SKI MOUNTAINEERING, SKI MOUNTAINEERING, ALPINE SKIING, ALPINISM

- Lightweight in-mold EPS construction with a durable polycarbonate shell
- EN 12492 and EN 1077/B certified in accordance with ISMF rules
- Ventilation holes on the sides and back for excellent breathability
- Foam padding is lined with soft microfiber for sweat absorption and comfort
- Size adjustment wheel is easy to operate with one hand
- Dedicated elastic straps keep ski goggles in the optimal position even when they are not being used
- Headlamp holder with clips on the front and elastic cord on the back
- Size can be customized with a special adapter kit (included)
- Available in 3 colors

The Speed Comp is in accordance with the ISMF rules that state that helmets must meet both EN 12492 standards for alpinism and EN 1077/B standards for alpine skiing. The dual certification guarantees a higher level of safety for athletes, especially improved from the old standard for side impacts. C.A.M.P. went through multiple rounds of R&D to deliver a helmet that is very strong, yet comfortable and breathable enough for the high intensity of randonee racing. Other improved features include a special adapter system for adjusting the size of the helmet for smaller heads and a unique strap system for securing ski goggles in the optimal position even when they are not being used.

Ref.	Product name	Sizes		Weight		Construction	Shell material	CE	
				g	oz			EN 12492	EN 1077/B
0202	ROCKSTAR	53-62 cm	20.9-24.4 in	400	14.1	Hard shell	Polypropylene	•	•
2458	SPEED COMP	54-60 cm	21.3-23.6 in	350	12.4	In-mold	Polycarbonate	•	•

VOYAGER

3283

SKI COMP



COMPETITIVE SKI MOUNTAINEERING, SKI MOUNTAINEERING, ALPINE SKIING, ALPINISM



Video



4 White / Light Blue



1 White / Light Grey



2 Grey / Black



3 Basalt Grey / Green



- In-mold construction with ABS upper shell, EPS inner core, and lower protective PC layer
- 17 openings distributed throughout the shell for excellent ventilation
- Removable fabric padding with breathable mesh
- Anti-sweat padding kit included
- Detachable ear protection kit included
- Rear adjustment dial with rubber coated wheel for excellent grip
- Keeper system for goggles or headlamp uses three elastic attachment points for a light, secure and functional attachment that can be used while wearing the helmet
- Equipped with RECCO® reflector
- Available in 4 colors
- Available in 2 sizes
- Complies with EN 12492 and EN 1077/B standards in accordance with ISMF regulations

The Voyager is a ski mountaineering helmet designed to be compliant with ISMF regulations that require helmets to be dual certified for mountaineering (EN 12492) and alpine skiing (EN 1077 / B). The dual certification guarantees a higher level of safety for athletes especially from side impacts. To meet the stringent EN 1077 / B standard, the Voyager uses in-mold construction with an extremely hard and impact-resistant ABS plastic shell. The core interior is expanded polystyrene (EPS) that is reinforced with a layer of polycarbonate (PC) to help absorb shocks and further increase resistance. 17 openings in the shell are optimally positioned for maximum breathability. The breathable mesh padding can be interchanged with the included anti-sweat foam kit that includes the upper part for the head, pads for covering the adjustment dial, and a front part with two different thicknesses (5 mm and 10 mm) to fine-tune the fit. Earmuffs that can be attached and detached are also included making the Voyager a great helmet for all kinds of skiing. The keeper system for goggles or headlamp uses three pieces of elastic with hooks (one on each side and one on the back) for a lightweight, secure attachment. The system can be used while wearing gloves and without removing the helmet. The Voyager is also equipped with an internal RECCO® reflector making it traceable by mountain rescue operators equipped with RECCO® detectors (note: RECCO® technology does not replace an avalanche beacon in any way).



Ref.	Product name	Sizes		Weight		Construction	Shell material	CE	
				g	oz			EN 12492	EN 1077/B
3283	VOYAGER	54-58 cm	21.3-22.8 in	465	16.4	Hard shell + In-mold	ABS + Polycarbonate	•	•
		57-62 cm	22.4-24.4 in	475	16.8				



EARCOVER PADDING FOR SPEED COMP

2576

ALPINE SKIING, SKI MOUNTAINEERING

Ear protection kit that converts the Speed Comp helmet to a full-coverage downhill ski helmet. Attaches to the helmet with a simple, secure system. Made from soft padded fabric, with insulation to protect the ears from the cold and wind.



PADDING KIT FOR SPEED COMP

2678

- Speed Comp Helmet Padding Replacement Kit



HELMET LINERS

1585 200 pcs

The perfect solution for ropes courses and adventure parks to extend the life of helmets and prevent germs from spreading. Sold in dispensers of 200 pcs.



ROCKSTAR CRADLE

0110

- Rock Star Replacement Cradles



EARCOVER PADDING FOR VOYAGER

3342

- Voyager helmet replacement ear protection kit



PADDING FOR VOYAGER

3338 S size

3339 L size

- Voyager helmet padding replacement kit (2 sizes available)



FOAM PADDING KIT FOR VOYAGER

3340

- Voyager helmet foam padding replacement kit



DIAL KIT FOR VOYAGER

3341

- Replacement dials for Voyager



PADDING KIT FOR TITAN

2715

- Titan helmet padding replacement kit



CHIN STRAP KIT FOR TITAN

2717 Small
2716 Large

- Titan helmet chin strap replacement kit (2 sizes available)

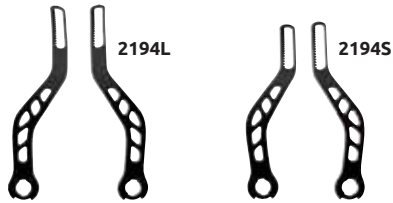

HEAD BAND SYSTEM FOR TITAN

2194S Small
2194L Large

- Titan helmet size adjustment system replacement kit (2 sizes available)



HEADLAMP HOLDER FOR TITAN

2718 4 pcs - Green
2719 4 pcs - Orange

- Titan helmet headlamp clip replacement kit
- Sold in a set of 4 (sufficient for 1 helmet)
- 2 colors available



PADDING KIT FOR STORM

2480

- Storm helmet padding replacement kit



PADDING KIT FOR ARMOUR

2646

- Armour Helmet Padding Replacement Kit



HEADLAMP HOLDER FOR ARMOUR

2647

- Armour Helmet Replacement Headlamp Clips
- Sold in sets of 4



DIAL KIT FOR SPEED COMP / STORM / ARMOUR

2639

- Replacement dial kit for Speed Comp, Storm and Armour helmets (for production batches before batch 11-22)



DIAL KIT FOR SPEED COMP / STORM / ARMOUR

3188

NEW

- Replacement dial kit for Speed Comp, Storm and Armour helmets (for production batches after batch 11-22)



CHIN STRAP PADDING FOR HELMETS

2067

- Replacement Helmet Chin Strap Pads
- Sold in bags of 5

VIA FERRATA



An oblique passage along the Roda di Vael via ferrata on the Catinaccio group in the Dolomites, Italy © Giacomo Meneghello

VIA FERRATA

The rise of via ferrata

Every summer, from the Brenta peaks to the Sella pass, historic paths are sieged by thousands of hikers who are now also exploring the wonderful world of via ferrata where outdoor enthusiasts of any age can enjoy the sights from up high that they will never see from the trails. The same is happening all across the Alps. Via ferrata is great fun because of the thrill of the heights and the exposure. That same thrill is also where the danger lies. This is why it is always important to climb with the necessary equipment like a helmet, harness, and lanyards designed to handle the falls that via ferrata can expose climbers to.

Via ferrata is still for the bold

There is a common misperception that via ferrata is less dangerous than technical rock climbing. As with anything, both activities can be safe if practiced with the right levels of skill and competence. Via ferrata, by its very nature, is dangerous which is why we say it is still for the bold. The lower angle terrain means there are more obstacles to hit in the event of a fall. No rope is in use to stop the progression of the fall before hitting the anchor point. Metal pegs, cables and the presence of other climbers only add to these hazards that are far less present in technical rock climbing. It is never a bad idea to hire a guide if you are a beginner. Doing so can really enhance the experience by helping to remove some of the concern and leaving more room for the fun.

Continuous innovation





The perpetual drive for innovation at C.A.M.P. has resulted in the most efficient and safe systems for fall protection in via ferrata. In addition to purpose-built carabiners designed to maximize performance and safety like the new Echo with an ergonomic design and large opening to facilitate easy handling and connection to anchors, C.A.M.P. now uses Rewind technology in both the lanyards to hold the kit closer to the harness making it even more convenient for climbing. Our most notable innovation remains the Gyro system that features three independent swivels where the lanyards connect to the harness to prevent the annoying and potentially dangerous twisting and tangling typical of traditional lanyard systems. That's three serious innovations in just a few short years!

Shock-absorbing systems

In climbing, the force of a fall is largely consumed by the dynamic rope. The more rope there is in the system, the more energy it can absorb. In via ferrata, there is no energy-absorbing rope; in some ways, this makes via ferrata even more dangerous than technical rock climbing. This is why the energy absorption systems built into via ferrata lanyards are so important: C.A.M.P. uses compact shock packs with lacerated stitching that is designed to break when a certain level of force is reached. In the breaking process, energy is absorbed before it is transmitted to the body. The Kinetic shock packs used in the entire range of via ferrata lanyards has been designed in accordance with the EN 958 standard of 2017 and the UIAA 128 standard.

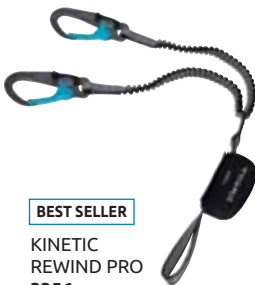

CATEGORY LEADERS

 <p>1ST CLASS KINETIC GYRO REWIND PRO 3355</p>	 <p>LIGHT&FAST KINETIC REWIND COMP 3359</p>	 <p>BEST SELLER KINETIC REWIND PRO 3356</p>	 <p>1ST CLASS AXION LIGHT FINGERLESS 3365</p>	 <p>BEST SELLER START 2042/2043</p>
---	---	---	---	---

Tests and inspections

As C.A.M.P. regularly tests its products, users must also check their equipment to make sure that it is always safe before use. Inspections should be done before, during and after each use. Equipment must be stored away from corrosive substances, direct sunlight, humid environments and high temperatures. Before and after each use, check for any damage caused by sharp edges which are often present in the metal systems used to rig via ferrata routes. Via ferrata lanyards are not designed to last forever. The maximum lifespan of a lanyard system is five years in order to minimize the possibility of failure in the field. The year of manufacturing can be found on the label stitched to the webbing ring that connects the lanyard to the harness. If the tag is unreadable, the lanyard should be retired immediately as this is evidence that the equipment has been subject to extensive wear and tear or potentially damaging environmental conditions. As via ferrata lanyards are designed to save lives in the event of catastrophic falls, it is important that the gear we rely on is never in question.

The EN 958 and UIAA 128 certifications

The EN 958 and the UIAA 128 standards specify via ferrata set safety requirements for users with a weight not lower than 40 kg (total weight without equipment) and not higher than 120 kg (total weight including equipment). The current edition uses two different tests with different masses. The first test is made with a 40 kg mass subjected to a fall factor 5: in this case the set must have a 220 cm maximum braking length and 3.5 kN maximum impact force. The second test is made with a 120 kg mass subjected to a fall factor 5: in this case the set must have 220 cm maximum braking length and 6 kN maximum impact force. The requirement for the breaking strength after the fall has to be at least 12 kN.

Lanyards

Ref.	Product name	Length		Weight		Lanyard material	Shock absorber system	Connectors	CE	UIAA
		cm	g	oz	EN 958:2017				128	
3355	KINETIC GYRO REWIND PRO	95-115	655	23.1		Rewind polyester 19 mm	Laceration	Echo	•	•
3356	KINETIC REWIND PRO	90-110	550	19.4		Rewind polyester 19 mm	Laceration	Echo	•	•
3357	KINETIC REWIND	87-107	510	18.0		Rewind polyester 19 mm	Laceration	Hercules	•	•
3358	KINETIC	98	420	14.8		Polyester 20 mm	Laceration	Nomad	•	•
3359	KINETIC REWIND COMP	84-104	415	14.6		Rewind polyester 19 mm	Laceration	Icarus	•	•

Via Ferrata Gloves

Ref.	Product name	Sizes	Weight / Pair (Size L)		Material			CE EN 388				STANDARD
			g	oz				Abrasion	Cut	Tear	Puncture	EN ISO 21420
1879	AXION	S-M-L-XL-XXL	140	4.9	Leather	•		3	1	3	3	•
187903	AXION BLACK	S-M-L-XL-XXL	140	4.9	Leather	•		3	1	3	3	•
2122	AXION LIGHT	S-M-L-XL-XXL	85	3.0	Leather + Synthetic	•		2	1	3	2	•
3365	AXION LIGHT FINGERLESS	XS-S-M-L-XL	62	2.2	Leather + Synthetic		•	3	1	3	2	•
2043	START FULL FINGER	XS-S-M-L-XL	88	3.1	Synthetic	•		3	1	3	2	•
2042	START FINGERLESS	XS-S-M-L-XL	72	2.5	Synthetic		•	3	1	3	2	•

SIZE CHART

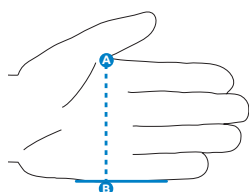

cm	Alphabetical sizes	Numerical sizes
5.8 - 6.5	XS	5
6.5 - 7.5	S	6
7.5 - 8.5	M	7
8.5 - 9.8	L	8
9.8 - 11.0	XL	9
11.0 - 12.2	XXL	10

To determine your size, open your hand and **measure the palm width from point A to point B**. Round to the nearest size.

Note. Measurements refer to hand size, not to product size. They can be used to help you determine your size, but the fit for each specific glove will vary based on its intended use. If possible, it is always best to try on gloves before purchasing.

VIA FERRATA

Lanyards



KINETIC GYRO REWIND PRO
3355



KINETIC REWIND PRO
3356



KINETIC REWIND
3357



KINETIC
3358



KINETIC REWIND COMP
3359

Via Ferrata Kits



KIT FERRATA KINETIC REWIND
ENERGY CR 4
3366



KIT FERRATA KINETIC REWIND
TOPAZ II
3368



KIT FERRATA KINETIC
TOPAZ II
3367

Via Ferrata Gloves



AXION
1879



AXION LIGHT
2122



AXION LIGHT FINGERLESS
3365



START FINGERLESS
2042



START FULL FINGER
2043



KINETIC GYRO REWIND PRO

3355

1ST CLASS DESIGN PAT. PEND.

VIA FERRATA

- Stitched shock absorber is lightweight and compact
- 19 mm Rewind webbing lanyards stay compressed and out of the way while climbing
- Gyro system has three independently rotating swivels to prevent twisting and tangling
- Equipped with Echo squeeze-activated carabiners with ergonomic design and large opening to facilitate easy handling and connection to anchors
- Durable webbing twist ring keeps the lanyards in their proper orientation
- Certified in accordance with safety requirements fixed by the EN 958 and UIAA 128 standards

The Kinetic Gyro Rewind Pro via ferrata lanyard is a prime combination of our top-of-the-line via ferrata components. It features our light and compact stitched shock absorber that is compliant with EN 958 and UIAA 128 standards, super-safe Echo carabiners and the Gyro system that is designed to eliminate twisting and tangling. The lanyards use special elasticized 19 mm Rewind webbing that contracts to a shortened length to stay out of the way while climbing but extend effortlessly to full length for passing anchors or straying from fixed lines. Connects to any harness with a webbing twist ring that positions the unit in its upright position even when passed through vertical tie-in points.



KINETIC REWIND PRO

3356

BEST SELLER

VIA FERRATA

- Stitched shock absorber is lightweight and compact
- 19 mm Rewind webbing lanyards stay compressed and out of the way while climbing
- Equipped with Echo squeeze-activated carabiners with ergonomic design and large opening to facilitate easy handling and connection to anchors
- Durable webbing twist ring keeps the lanyards in their proper orientation
- Certified in accordance with safety requirements fixed by the EN 958 and UIAA 128 standards

The Kinetic Rewind Pro via ferrata lanyard is an advanced design featuring our light and compact stitched shock absorber, super-safe Echo carabiners, and 19 mm Rewind lanyards that contract to a shortened length to stay out of the way while climbing but extend effortlessly to full length for passing anchors or straying from fixed lines. Connects to any harness with a webbing twist ring that positions the unit in its upright position even when passed through vertical tie-in points.

VIA FERRATA

Ref.	Product name	Length		Weight		Lanyard material	Shock absorber system	Connectors	CE	
		cm	g	oz	EN 958:2017				UIAA 128	
3355	KINETIC GYRO REWIND PRO	95-115	655	23.1		Rewind polyester 19 mm	Laceration	Echo	•	•
3356	KINETIC REWIND PRO	90-110	550	19.4		Rewind polyester 19 mm	Laceration	Echo	•	•



KINETIC REWIND

3357

VIA FERRATA

- Stitched shock absorber is lightweight and compact
- 19 mm Rewind webbing lanyards stay compressed and out of the way while climbing
- Equipped with Hercules squeeze-activated carabiners
- Durable webbing twist ring keeps the lanyards in their proper orientation
- Certified in accordance with safety requirements fixed by the EN 958 and UIAA 128 standards

A lightweight via ferrata lanyard set designed with our light and compact stitched shock absorber to absorb the energy of a fall. The lanyards use special elasticized 19 mm Rewind webbing that compacts to a shortened length to stay out of the way while climbing but extend effortlessly to full length for passing anchors or straying from fixed lines. Connects to any harness with a webbing twist ring that positions the unit in its upright position even when passed through vertical tie-in points. Equipped with Hercules squeeze-activated carabiners.



KINETIC

3358

VIA FERRATA

- Stitched shock absorber is lightweight and compact
- 20 mm webbing lanyards equipped with Karstop Evo retainers to keep the carabiners in the correct position
- Equipped with Nomad slide-locking carabiners
- Durable webbing twist ring keeps the lanyards in their proper orientation
- Certified in accordance with safety requirements fixed by the EN 958 and UIAA 128 standards

Via ferrata lanyard set designed with our light and compact stitched shock absorber to absorb the energy of a fall. The Y-formation formed from strong 20 mm webbing allows the climber to pass fixtures while remaining securely attached to the wall. Connects to any harness with a webbing twist ring that positions the unit in its upright position even when passed through vertical tie-in points. Equipped with Nomad slide-locking carabiners.



KINETIC REWIND COMP

3359

LIGHT&FAST SKI COMP



COMPETITIVE SKI MOUNTAINEERING, VIA FERRATA

- Stitched shock absorber is lightweight and compact
- 19 mm Rewind webbing lanyards stay compressed and out of the way while climbing
- Lanyards equipped with Karstop Evo retainers to keep the carabiners in the correct position
- Equipped with lightweight Icarus carabiners
- Webbing twist ring connects quickly to any harness and keeps the lanyards in their proper orientation
- Certified in accordance with safety requirements fixed by the EN 958 and UIAA 128 standards

The Kinetic Rewind Comp is our lightest via ferrata set, specifically designed for ski mountaineering competitions. It features our light and compact stitched shock absorber and lightweight elasticized 19 mm Rewind webbing lanyards that compact to a shortened length to stay out of the way while climbing but extend effortlessly to full length for passing anchors or straying from fixed lines. Quickly connects to any harness with the webbing twist ring that keeps the lanyards in their proper orientation even when passed through vertical tie-in points. Equipped with lightweight Icarus carabiners for easy one-handed operation.

Ref.	Product name	Length		Weight		Lanyard material	Shock absorber system	Connectors	CE EN 958:2017	UIAA 128
		cm		g	oz					
3357	KINETIC REWIND	87-107		510	18.0	Rewind polyester 19 mm	Laceration	Hercules	•	•
3358	KINETIC	98		420	14.8	Polyester 20 mm	Laceration	Nomad	•	•
3359	KINETIC REWIND COMP	84-104		415	14.6	Rewind polyester 19 mm	Laceration	Icarus	•	•



KIT FERRATA KINETIC REWIND ENERGY CR 4 3366

VIA FERRATA

- Our top-of-the-line via ferrata kit
- Certified in accordance with safety requirements fixed by the EN 958 and UIAA 128 standards
- Includes:
Kinetic Rewind Set (3357),
Energy CR4 Harness (2871-1 Grey),
Titan Helmet (2127-3 White)
- Available in 2 versions (S and L) with harness and helmet of different sizes



KIT FERRATA KINETIC REWIND TOPAZ II 3368

VIA FERRATA

- A high-end, versatile via ferrata kit
- Certified in accordance with safety requirements fixed by the EN 958 and UIAA 128 standards
- Kit includes:
Kinetic Rewind Set (3357),
Topaz II Harness (3215),
Armour Helmet (2595-L3, Large Gray)



KIT FERRATA KINETIC TOPAZ II 3367

VIA FERRATA

- Our most cost-effective via ferrata kit
- Certified in accordance with safety requirements fixed by the EN 958 and UIAA 128 standards
- Kit includes:
Kinetic Via Ferrata Set (3358),
Topaz II Harness (3215),
Rockstar Helmet (0202-11)



1879



187903

AXION

1879
187903 Black

ROCK CLIMBING, VIA FERRATA

- Constructed from premium grade leather
- Reinforced double layer leather palm
- Main body construction uses elastic inserts for good flexibility
- Rubber padding on the knuckles

Our most durable gloves. Constructed from premium grade leather for a precise fit and reinforced in areas that usually see higher amounts of abrasion. A great choice for long rappels and lowers.



2122



3365

AXION LIGHT

2122 Full finger
3365 Fingerless

1ST CLASS

ROCK CLIMBING, VIA FERRATA

- Palm constructed from premium grade leather
- Main body constructed from lightweight, breathable stretch fabric
- Elastic wrist with Velcro closure
- Soft leather combines with a precision fit for the best comfort, dexterity and sensitivity
- Available with full or half fingers

A comfortable glove for work on ropes with construction and materials specifically designed for durability and performance. The palm is constructed from premium goatskin leather and the back uses light and breathable mesh fabric for maximum dexterity and comfort. The cuff is constructed from durable elastic with a strong Velcro closure.



2043



2042

START



2043 Full finger
2042 Fingerless

BEST SELLER

VIA FERRATA, ROPE COURSES & INSTITUTIONAL

- Full synthetic construction for wet or hot conditions
- Abrasion resistant fabric on the palm is reinforced on the thumb and index fingers
- Main body construction uses lightweight, breathable stretch fabric
- Sweat pads on the thumbs
- Available with full or half fingers

Full synthetic construction makes these gloves breathable so they remain comfortable even when wet. All wear points are reinforced for maximum durability.

Ref.	Product name	Sizes	Weight / Pair (Size L)		Material	 	EN 388				STANDARD EN ISO 21420
			g	oz			Abrasion	Cut	Tear	Puncture	
1879	AXION	S-M-L-XL-XXL	140	4.9	Leather	•	3	1	3	3	•
187903	AXION BLACK	S-M-L-XL-XXL	140	4.9	Leather	•	3	1	3	3	•
2122	AXION LIGHT	S-M-L-XL-XXL	85	3.0	Leather + Synthetic	•	2	1	3	2	•
3365	AXION LIGHT FINGERLESS	XS-S-M-L-XL	62	2.2	Leather + Synthetic	•	3	1	3	2	•
2043	START FULL FINGER	XS-S-M-L-XL	88	3.1	Synthetic	•	3	1	3	2	•
2042	START FINGERLESS	XS-S-M-L-XL	72	2.5	Synthetic	•	3	1	3	2	•

PACKS



Amazing color contrasts in the Bolivian Andes with the Sajama volcano (6542 m) in the background © Giacomo Meneghello

PACKS

Designs and Systems

Our packs are crafted for optimal performance thanks to our focus on materials and fabric patterns combined with innovations that make your adventures faster and easier. The first thing most people notice about C.A.M.P. packs is their trim cuts and minimalist systems. This is because every product is designed by a group of mountain athletes who live by the basic principle that less can indeed be more. C.A.M.P. packs are loaded with systems, but they have a tendency to be more streamlined and simplistic than those of other pack manufacturers who use bells and whistles in an effort to 'oversell' the features. We also design most systems to tuck away when not in use in order to eliminate the potential for snagging in tight spaces typical of climbing, ski-mountaineering and backcountry hiking. Below is a short list of features that demonstrate the innovation of our line:

- **X-Press.** An innovative system for attaching and removing skis without removing the pack. The skier simply slides the tails into the loop at the left hip, flips the tips to the right shoulder and grabs them to the shoulder strap.
- **Super fast trekking pole carrying system.** This innovative system is equipped on the Trail Force vest packs. It is derived from the X-Press ski carrying system on our ski mountaineering backpacks. It allows the poles to be attached and removed without stopping or removing the pack. The system uses elastic cords that are fixed to the poles that can then be captured by a carabiner (included). Once the poles are clipped together, the carabiner gets clipped to a loop on the back left-side of the pack and then the tips of poles get captured by the X-Press strap on the right shoulder for a very secure and fast attachment.
- **Easy Access Crampons Pocket.** The bottom portion of our competitive ski mountaineering packs and of the Ski Raptor 20 and 30 feature a fast access pocket for crampons to keep them at the ready. If crampons are not part of the mandatory gear, it is also a perfectly situated pocket for water bottles, snacks and layers.
- **Full Backdoor.** Many of our alpine and ski touring packs use the space between the padding on the back panel as a duffle style zipper opening allowing access to the entire contents of the packs without having to remove everything on top before gaining access to gear at the bottom.
- **XAir.** An innovative back ventilation system on the M20, M30 and M45 models. It uses 3D EVA foam pads with horizontal ventilation channels in the parts that are in contact with the body. The padding is situated in an X shape for an open air design that channels air away from the back for increased comfort during intensive use.
- **Balance System.** A unique feature that allows the user to balance the load using just two straps on top of the shoulders. The Balance System links these straps to the low-center part of the pack where the weight is consolidated and works to compress, stabilize and situate the load without removing the pack.

The Line

C.A.M.P. offers a complete collection of packs, each purpose-built for the objective. The range includes packs for mountaineering, alpinism, rock climbing, big wall, ski mountaineering and trail running.

- **Mountaineering.** This is our high-end alpine climbing and mountaineering line. The M20 is the right choice for multi-pitch alpine climbing. The M30 is developed for fast & light ascents on big peaks, and the M45 is the best for mountaineering and alpinism typical of the great ranges. The M-Tech has been specifically designed for carrying on route with trim profiles and sophisticated features that make big routes more manageable. Fans of big wall climbing will also be impressed by the Supercargo 70 and 40 haul bags.



CATEGORY LEADERS



1ST CLASS

M20
3205



BEST SELLER

M30
3206



1ST CLASS

SUMMIT 30
3299



1ST CLASS BEST SELLER

SKI RAPTOR 30
3147



LIGHT&FAST

RAPID RACING
2969

- **Climbing.** These packs are designed to swallow gear in quick, organized and systematic ways. Climbers particularly like the large duffle style and Backdoor openings that make loading a bulky rack or rope super easy.
- **Ski Mountaineering.** The Rapid Racing is the minimalist's choice for ski mountaineering competitions with its amazing combination of features, fit, weight and function. The Rapid is also fine-tuned to facilitate the specific maneuvers common in ski mountaineering competitions, but it is also an excellent choice for light and fast tours in the backcountry. The Ski Raptor 20 and 30 build on our years of experience in skimo racing and integrate many of the features into a next level freeride pack for fast and light romps in the backcountry.
- **Trail Multisport.** A complete range of vest packs designed for training, racing, ultra-running and peak-bagging at the highest level. The range features packs for training and trail raids of every shape and size. The Trail Force 2, 5, 10 and 20 are specifically designed for speed with particular attention paid to wearability and comfort.

Mountaineering

Ref.	Product name	Capacity	Weight		X-PRESS	BACK DOOR	H ₂ O	ICE AXE	HELMET	ROPE	BOTTLES	HIP BELT
			g	oz								
3074	M-TECH	22 L	650	22.9			•	•	•	•		
3207	M45	45 L	1230	43.4	Lateral	•	•	•	•	•	•	1
3206	M30	30 L	1125	39.7	Lateral	•	•	•	•	•	•	1
3205	M20	20 L	735	25.9	Lateral	•	•	•	•	•	•	
2915	SUPERCARGO 40	40 L	2900	102.4								
2775	SUPERCARGO 70	70 L	3400	120.0								

Climbing

Ref.	Product name	Capacity	Weight		BACK DOOR
			g	oz	
3086	ROX ALPHA	40 L	900	31.8	•
3073	ROX	40 L	470	16.6	
0473	ROCKY CARPET - 100x150 cm		278	9.8	

Ski Mountaineering

Ref.	Product name	Capacity	Weight		X-PRESS	BACK DOOR	H ₂ O	ICE AXE	HELMET	ROPE	BOTTLES	HIP BELT
			g	oz								
2969	RAPID RACING	20 L	300	10.6	X-Press		•	•	•			
2977	RAPID	20 L	590	20.8	X-Press		•	•	•			
3147	SKI RAPTOR 30	30 L	930	32.8	X-Press	•	•	•	•			2
3146	SKI RAPTOR 20	20 L	790	27.9	X-Press	•	•	•	•			2
3299	SUMMIT 30	30 L	1090	38.5	Lateral	•	•	•	•	•	•	1

Trail Multisport

New	Ref.	Product name	Capacity	Sizes	h		cm		Weight		H ₂ O	BOTTLES
					h (cm)	h (in)	cm	in	g	oz		
	3100	TRAIL FORCE 20	20 L	XS-M	150-175	59.1-68.9	69-85	27.2-33.5	420	14.8	•	•
M-L				175-195	68.9-76.8	85-115	33.5-45.3	458	16.2			
	3099	TRAIL FORCE 10	10 L	XS-M	150-175	59.1-68.9	69-85	27.2-33.5	189	6.7	•	
M-L				175-195	68.9-76.8	85-115	33.5-45.3	200	7.1			
	3098	TRAIL FORCE 5	5 L	XS-M	150-175	59.1-68.9	69-85	27.2-33.5	168	5.9	•	
M-L				175-195	68.9-76.8	85-115	33.5-45.3	177	6.2			
	3097	TRAIL FORCE 2	2 L	XS-M	150-175	59.1-68.9	69-85	27.2-33.5	159	5.6	•	
M-L				175-195	68.9-76.8	85-115	33.5-45.3	164	5.8			
	3348	OUTBACK 20	20 L						950	33.5	•	•
	3105	OUTBACK 5	5 L						270	9.5	•	
	2594	SC 200	0.2 L						11	0.4		
	2592	SF 300	0.3 L						33	1.2		
	2593	SF 600	0.6 L						44	1.6		
NEW	3464	SF HOLDER							26	0.9		
	1794	ACTION BOTTLE	0.75 L						100	3.5		
	2137	BOTTLE HOLDER - 2 pcs							62	2.2		



SKI CARRYING SYSTEM



BACK DOOR



HYDRATION COMPATIBLE



ICE AXE HOLDER(S)



HELMET CARRIER



ROPE CARRIER



BOTTLE HOLDERS COMPATIBLE



HIP BELT POCKET



EASY-ENTRY CRAMPON POCKET

PACKS

Mountaineering



M-TECH
3074



M45
3207



M30
3206



M20
3205



SUPERCARGO
2915/2775

Climbing



ROX ALPHA
3086



ROX
3073



ROCKY CARPET
0473

Ski Mountaineering



RAPID RACING
2969



RAPID
2977



SKI RAPTOR 30
3147



SKI RAPTOR 20
3146



SUMMIT 30
3299

Trail Multisport



TRAIL FORCE 20
3100



TRAIL FORCE 10
3099



TRAIL FORCE 5
3098



TRAIL FORCE 2
3097



OUTBACK 20
3348



OUTBACK 5
3105



SF HOLDER
3464



BOTTLE HOLDER
2137

M-TECH

3074

ALPINISM, ROCK CLIMBING, MULTI-PITCH CLIMBING, ICE CLIMBING



- Technical pack for rock, ice and mixed mountain ascents
- Constructed from very strong fabric with a reinforced bottom
- Technical ice axe holders with a Hypalon reinforced head-locker system on the bottom and removable Velcro straps on top
- External helmet carrying system can be stowed away when not in use
- Frameless back is lined with a 6 mm EVA foam pad
- Connection points for the bottoms of the shoulder straps are higher for better weight distribution while climbing
- Rope carrying system allows the rope to be carried on top of or under the lid
- Innovative fast pull cord closure system has been optimized for use with gloves
- Transparent weatherproof pocket on the inside of the lid is touchscreen compatible for phones and maps
- Large zippered inner pocket for valuables
- 4 gear loops on the interior for organization
- 4 webbing loops on the exterior for rigging extra gear (webbing/shock cord not included)
- Capacity is variable from 20-22 liters with the double closure system and roll top lid
- Ergonomic shoulder straps are padded for the best comfort
- The shoulder straps are spaced to allow for an ice axe to be holstered quickly and comfortably between the pack and the back – a common practice for mountain guides
- Waist belt is removable and features two adjustment points for a precision fit
- Removable chest strap is height adjustable
- Strong webbing handle on top for transport and clipping
- Hydration compatible

The M Tech is designed for fast and light missions on multi-pitch rock and ice routes. Comfortable, strong and designed to be particularly functional for light and fast alpine missions and big multi-pitch routes. It features a long and narrow shape that has been profiled to be worn while climbing. The double closure system with the roll top lid allows the climber to stuff it full for the approach and then compress it down around everything that stays in the pack for the climb. The fast pull cord closure system is easy to use while wearing gloves and the lid features a transparent weatherproof pocket on the inside that is touchscreen compatible for phones and maps. The rope holder can be used to carry the rope both on top of or under the lid so it can also be hidden when not in use. The external helmet carrying system stows away when not in use and the Velcro keepers for the ice axe handles and the waist belt can be removed when not in use to further streamline the exterior of the pack for climbing. Following in the footsteps of the award-winning Eghen 22, the M Tech is perfect choice for climbers who need one pack to tackle big objectives done in a day.

Ref.	Product name	Capacity	Weight									
			g	oz								
3074	M-TECH	22 L	650	22.9								

M45 3207

ALPINISM



1 Red



2 Anthracite Grey



- Full BackDoor access with sleeve for hydration bladder
- XAir ventilated back with soft breathable mesh
- 3 mm aluminum wire frame
- Ergonomic shoulder straps for a performance fit
- Padded waist belt is removable for technical activities
- Waist belt features one zippered pocket and one gear loop
- Balance System allows for load adjustment, compression and stabilization using the two straps on the shoulders
- Removable lid features a large main compartment and a smaller compartment on the bottom for valuables
- Protective cover can be pulled out to cover the top of the pack when the lid is removed
- 2 interior elastic zip pockets
- 2 ice axe holders with removable elastic cords on top and head-locker system on the bottom
- A-Frame ski carrying straps can be hidden when not in use and can be reversed to be used as lashing straps for a snowboard or other accessories
- External helmet carrying system can be hidden when not in use
- Hydration compatible

The M45 does a brilliant job merging the capacity of a large pack with the stability, fit and performance of a smaller pack. It incorporates many of the unique features found in the C.A.M.P. backpacks range like the Full BackDoor panel that allows access to the contents of the pack without having to remove everything on top before gaining access to gear at the bottom. Comfort is assured by the XAir ventilated back with a 3 mm aluminum wire frame and breathable, ergonomic shoulder straps. The padded waist belt is removable for technical activities. It features one zippered pocket and one gear loop. The innovative Balance System uses the same two straps on the top of the shoulders to simultaneously adjust, compress and stabilize the load by pull from the bottom of pack instead of the top. The removable lid features a large main compartment on top and a smaller compartment on the bottom for valuables. A protective cover can be pulled out to cover the top of the pack when the lid is removed. Additional technical features include two ice axe holders with removable elastic cords on top and head-locker system on the bottom, reversible ski carrying straps that can also be used to carry a snowboard or hidden when not in use, an external helmet carrying system that can be hidden when not in use, hydration bladder compatibility, and large elastic zip pockets on the inside of the main compartment for extra organization.

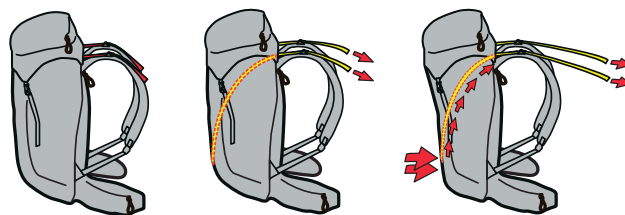

Video

Ref.	Product name	Capacity	Weight		X PRESS	BACK LOCK	H ₂ O	/	/	/	/	/	
			g	oz									
3207	M45	45 L	1230	43.4	Lateral	•	•	•	•	•	•	•	1

M30

3206

BEST SELLER

ALPINISM, ICE CLIMBING



1 Red



2 Anthracite Grey



- Full BackDoor access with sleeve for hydration bladder
- XAir ventilated back with soft breathable mesh
- 3 mm aluminum wire frame
- Ergonomic shoulder straps for a performance fit
- Padded waist belt is removable for technical activities
- Waist belt features one zippered pocket and one gear loop
- Balance System allows for load adjustment, compression and stabilization using the two straps on the shoulders
- Removable lid features a large main compartment and a smaller compartment on the bottom for valuables
- Protective cover can be pulled out to cover the top of the pack when the lid is removed
- 2 interior elastic zip pockets
- 2 ice axe holders with removable elastic cords on top and head-locker system on the bottom
- A-Frame ski carrying straps can be hidden when not in use and can be reversed to be used as lashing straps for a snowboard or other accessories
- External helmet carrying system can be hidden when not in use
- Hydration compatible

30 liters is a great size for one-day excursions in the backcountry, leaving room for the essentials but cutting the weight of excess capacity. The M30 incorporates many of the unique features found in the C.A.M.P. backpacks range like the Full BackDoor panel that allows access to the contents of the pack without having to remove everything on top before gaining access to gear at the bottom. Comfort is assured by the XAir ventilated back with a 3 mm aluminum wire frame and breathable, ergonomic shoulder straps. The padded waist belt is removable for technical activities. It features one zippered pocket and one gear loop. The innovative Balance System uses the same two straps on the top of the shoulders to simultaneously adjust, compress and stabilize the load by pull from the bottom of pack instead of the top. The removable lid features a large main compartment on top and a smaller compartment on the bottom for valuables. A protective cover can be pulled out to cover the top of the pack when the lid is removed. Additional technical features include two ice axe holders with removable elastic cords on top and head-locker system on the bottom, reversible ski carrying straps that can also be used to carry a snowboard or hidden when not in use, an external helmet carrying system that can be hidden when not in use, hydration bladder compatibility, and large elastic zip pockets on the inside of the main compartment for extra organization.

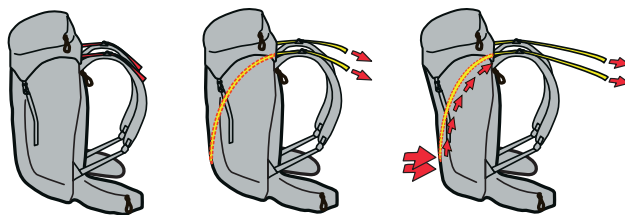

Video

Ref.	Product name	Capacity	Weight		X PRESS	BACK DOOR	H ₂ O	Ice Axe	Head Locker	Ski Straps	Hydration	Helmet
			g	oz								
3206	M30	30 L	1125	39.7	Lateral	•	•	•	•	•	•	•

M20 3205

1ST CLASS

ALPINISM, MULTI-PITCH CLIMBING, ICE CLIMBING

- Full BackDoor access with sleeve for hydration bladder
- XAir ventilated back with soft breathable mesh
- Ergonomic shoulder straps for a performance fit
- Padded waist belt is removable for technical activities
- Waist belt features two gear loops
- System for load adjustment using the two straps on the shoulders
- Zip top lid combines with drawstring closure for extra security and protection from the elements
- The zip top lid also functions as a content divider for better organization and load balancing
- 2 high-capacity elastic pockets and 1 large vertical zipper pocket on the exterior for extra capacity
- Technical ice axe holders with a head-locker system on the bottom and elastic cords on top
- A-Frame ski carrying straps can be hidden when not in use
- External helmet carrying system can be hidden when not in use
- Rope carrying straps can be hidden when not in use
- Hydration compatible

The M20 is a sophisticated lightweight pack for fast packing and general outdoor adventures. It incorporates many of the unique features found in the C.A.M.P. backpacks range like the Full BackDoor panel that allows access to the contents of the pack without having to remove everything on top before gaining access to gear at the bottom. Comfort is assured by the XAir ventilated back and breathable, ergonomic shoulder straps. The padded waist belt with two gear loops is removable for technical activities. A particular system allows for load adjustment using the two straps on the shoulders. The zip top lid combines with a drawstring closure for extra security and protection from the elements. Additional technical features include two technical ice axe holders with head-locker system and elastic cords, A-Frame ski carrying straps and external helmet carrying system that can be hidden when not in use, hydration bladder compatibility, and large external pockets for extra capacity.



1 Red



2 Anthracite Grey



Video

Ref.	Product name	Capacity	Weight		X PRESS	TECH BOOK	H ₂ O	/	/	/	/	/
			g	oz								
3205	M20	20 L	735	25.9	Lateral	•	•	•	•	•	•	•



2915



2775

SUPERCARGO

2915 40 L

2775 70 L

AID CLIMBING, ALPINISM

- Highly technical haul bag available in two sizes: 70 and 40 liters
- The 70 liter version is a true Grade V haul bag for big walls
- The 40 liter version is ideal for advanced aid climbing and lighter loads
- Constructed from super strong and amazingly wear-resistant Tarpaulin TPU 4500D fabric
- Tarpaulin TPU 4500D main fabric is particularly resistant to low temperatures for extreme conditions
- Main body is high-frequency welded for the highest strength and perfectly cylindrical shape
- Reinforced bottom with drain holes
- Structural crossed webbing attachment points on the bottom for clipping a portaledge, sub-bag or poop tube
- Fully adjustable padded shoulder straps (with Balance System on the 70 liter version for load adjustment) can be tucked into a protected pocket for hauling and travel
- Height adjustable chest strap
- Removable padded waist belt with two adjustment points can also be used as a soft bosun chair when removed
- Differentiated length haul straps for easy access while clipped off; handles and daisy chain tie-off points on the insides
- Large interior security pocket with zip closure and handle
- 3 fixed gear loops on the interior
- Roll-top lid with plastic buckle, cinch system and security strap for a solid closure and easy opening

The Supercargo is a true Grade V haul bag with technical features designed for the advanced aid climber. Wide shoulder straps and padded waist belt makes it comfortable for carrying on the back. For hauling and climbing, the shoulder straps tuck away into a protected compartment and the waist belt can be removed and used as a bosun chair at belays. Strong and rigid Tarpaulin TPU 4500D fabric is reinforced on the bottom and stands upright for easy packing. The differentiated length main haul straps on the top allow for easy access even when they are being used as the primary attachment point. Other clipping points include handles and daisy chain attachments on the insides of the haul straps and structural crossed webbing straps on the bottom for clipping a portaledge, sub-bag or poop tube. Interior main compartment features one large zip pocket and 3 dedicated gear loops.

Supercargo 40



Supercargo 70



Ref.	Product name	Capacity	Weight	
			g	oz
2915	SUPERCARGO 40	40 L	2900	102.4
2775	SUPERCARGO 70	70 L	3400	120.0



ROX ALPHA

3086

SPORT CLIMBING, ROCK CLIMBING

- A technical pack designed for outdoor climbing with an approach
- Full BackDoor access allows for fast and easy access to the contents of the pack
- Ventilated back with thermoformed padding for exceptional comfort on long approaches
- 3 mm aluminum wire frame
- Ergonomic shoulder straps for a performance fit
- Padded waist belt with two adjustment points
- Removable chest strap is height adjustable
- Large mesh pocket on the inner part of the back panel
- Zip top lid features one exterior pocket and one interior pocket for valuables
- Large front pocket with vertical zip designed to carry a guidebook
- Dedicated inner pocket for chalk and chalk bag
- Top handles on the front and back for easy transport

The Rox Alpha is a technical pack designed to optimize a typical day of outdoor climbing with an approach. It features a ventilated back with thermoformed padding for exceptional comfort, a 3 mm aluminum wire frame for good stability, ergonomic shoulder straps and a padded waist belt with two adjustment points for a precision fit. Full BackDoor access allows fast and easy access to all of the contents of the pack without having to unload everything on top to get to the bottom of the pack. Organization is accomplished with dedicated pockets for all of the essentials including a large mesh pocket on the inner back panel, two zippered lid pockets, a front zip pocket for a guidebook and a dedicated inner pocket for chalk and chalk bag. The 40 liter main compartment is the right size for carrying a rope, 2 pairs of shoes, harness, quickdraws, layers and other essentials for an enjoyable day of climbing.



2 Lime

1 Black

3 Light Blue

ROX

3073

SPORT CLIMBING, CLIMBING GYMS

- Designed for the gym and outdoor sport climbing
- Easy to move quickly from one sector of the gym or crag to another
- Padded back for comfort even when fully loaded
- Ergonomic shoulder straps
- Strong webbing handles for easy transport
- 1 elastic mesh external side pocket
- 1 large inner pocket
- Available in 3 colors

The Rox is a streamlined pack designed to carry the essentials for the gym or crag in a way that makes them easy to transport and easy to access. The large main compartment is accessed with a full-length zipper. 40 liter capacity fits a rope, 2 pairs of shoes, harness, quickdraws and other session essentials. Also features a small inner pocket for valuables and one mesh pocket on the exterior for chalk or water.



ROCKY CARPET

0473 100x150 cm

SPORT CLIMBING

As simple as it seems, a good rope tarp truly improves your crag experience. The large pocket is ideal for packing an uncoiled rope (minimizes tangles). Four color-coded tie-in points help coordinate rope ends. Start with orange as the sharp end and gray for the belay end, then after the climb, attach the sharp end to gray and restack to use the other end of the rope for the next lead. Voila! No more tangled ropes.

Ref.	Product name	Capacity	Weight		
			g	oz	
3086	ROX ALPHA	40 L	900	31.8	•
3073	ROX	40 L	470	16.6	
0473	ROCKY CARPET - 100x150 cm		278	9.8	



1 Black



RAPID RACING

2969

LIGHT&FAST

SKI COMP

PAT. PEND.



COMPETITIVE SKI MOUNTAINEERING

- X-Press ski carrying system designed by our top skimo athletes for the fastest transitions in races
- The hook features an ergonomic tab and a bungee system that automatically retracts it back into position when not in use
- Lower loop for ski tails is adjustable for better ergonomics and faster transitions
- Extra ski carrying system for a second pair of skis with an upper strap that can be stowed away and a removable lower strap
- Side entry crampon pocket is easily accessed without removing the pack, equipped with Velcro and magnets for fast and secure closure and can be zipped open from the inside to connect to the main compartment
- Lightweight ice axe holder can be removed when it is not being used
- Durable elastic Truck Bull tethering system for pulling a partner in team races
- Internal pocket for accessories
- Internal compartment for shovel handle and probe
- Internal buckles for securing the shovel blade
- Soft back with super light and breathable mesh
- Breathable mesh shoulder straps with webbing strap for bottle holder
- Ergonomic waist belt for better load stabilization
- Height-adjustable and removable chest strap with fast buckle
- Hydration compatible
- Built-in emergency whistle

The Rapid Racing has won everything over the years, from the World Cup to the classics of the Grande Course, and the evolution continues! Once again, our athletes have gone deep into the development of the next generation with a new X-Press ski carrying system that they designed themselves. The new system features an innovative hook with an ergonomic tongue that is very fast to grab and hook to the skis. The hook self-retracts back into position so it stays out of the way when not in use. It is also adjustable in length from the inside so it can be tensioned perfectly for specific skis. The bottom loop is positioned for the best ergonomics for quickly inserting skis. It can also be adjusted to fit precisely with specific skis and bindings. The external crampon compartment uses Velcro and magnets for a fast and secure closure. Other tried and true features and the lightweight materials and profiled fit remain.

Ref.	Product name	Capacity	Weight		X-PRESS	BACK HOOK	H ₂ O	ICE AXE	SHOVEL	SPOON	HYDRATION	ICE AXE
			g	oz								
2969	RAPID RACING	20 L	300	10.6	X-Press		•	•	•			



1 Orange



RAPID

2977

SKI COMP



SKI MOUNTAINEERING, COMPETITIVE SKI MOUNTAINEERING

- X-Press ski carrying system with Tubular Rewind allows skis to be attached and removed without removing the pack
- Side entry crampon pocket is easily accessed without removing the pack, equipped with Velcro and magnets for fast and secure closure and can be zipped open from the inside to connect to the main compartment
- Innovative ice axe holder is secured with webbing on the bottom and elastic on top to allow access to the axe without removing the pack
- Durable elastic Truck Bull tethering system for pulling a partner in team races
- Internal pocket for accessories
- Internal compartment for shovel handle and probe
- Internal buckles for securing the shovel blade
- Lightweight, breathable mesh on the back with 4 mm EVA padding
- Ergonomic shoulder straps with 4 mm EVA padding and lightweight, breathable mesh for exceptional comfort
- Waist belt is equipped with elastic pockets on both sides
- Storage pockets and bottle holder on the shoulder straps
- Ergonomic waist belt for better load stabilization
- Height-adjustable and removable chest strap with fast buckle
- Hydration compatible

The Rapid is a tried and true technical ski touring pack with all the features that make our Rapid Racing pack a leader in the race category, but built with materials and features that make it more compatible for general ski touring. Still lightweight at 590 grams with ergonomics that make it fit close to the body for all day comfort. Features include the X-Press ski carrying system that allows skis to be attached and removed without removing the pack, the side entry crampon pocket that can be accessed without removing the pack and uses Velcro and magnets for a secure closure, the innovative ice axe holder that allows the axe to be removed without removing the pack, the dedicated internal compartment for the probe and shovel handle and dedicated clips for the shovel blade, and external hip pockets and bottle holder on the shoulder strap to allow access to essentials without removing the pack.

Ref.	Product name	Capacity	Weight		X-PRESS	ISCMF	H ₂ O	Ice Axe	Shovel	Probe	Bottle	Ski
			g	oz								
2977	RAPID	20 L	590	20.8	•	•	•	•	•	•	•	•



3 Forest Green



4 Black



Video



SKI RAPTOR 30

3147

1ST CLASS

BEST SELLER

SKI MOUNTAINEERING

- Made from durable 420D nylon
- X-Press ski carrying system with Tubular Rewind allows skis to be attached and removed without removing the pack
- The tail loop for the X-Press ski carrying system can be set in two positions making it easy to insert skis whether the pack is fully loaded or mostly empty
- Skis can also be carried laterally with fast buckle attachments
- Side entry crampon pocket is easily accessed without removing the pack and can be zipped open from the inside to connect to the main compartment
- Dual hide-away ice axe carriers with sleeves to enclose the picks and aluminum plates that thread through the head of the tools at the bottom and removable straps at the top
- Hide-away system for carrying poles
- Hide-away elastic mesh helmet carrying system can be removed when not in use
- Dedicated fast access compartment on the front for shovel and probe with inner zipper pocket
- Ergonomic and ventilated back panel with a wide Full BackDoor opening and a sleeve pocket for a hydration bladder
- Padded shoulder straps feature external edging for greater comfort
- Waist belt is equipped with elastic pockets on both sides and a gear loop on the right hip
- Height adjustable chest strap
- Top zip pocket
- Top handle for easy transport
- Hydration compatible

The Ski Raptor 30 builds on our years of designing purpose-built packs for specific adventures. Utilizing design features from our benchmark skimo race packs, the Ski Raptor 30 is a truly unique freeride pack. Constructed from 420D ripstop nylon for incredible durability. Ventilated back panel and external edging on the shoulder straps for increased comfort. Other popular features remain like the X-Press ski carrying system that allows skis to be attached and removed without removing the pack, Full BackDoor access that makes gear accessible independent of where it is layered in the pack, hide-away and removable systems for carrying essential gear like poles, axes and helmet, a dedicated fast access pocket on the front for shovel and probe, and a dedicated side entry crampon compartment. The tail loop for the X-Press ski carrying system can be set in two positions making it easy to insert skis whether the pack is fully loaded or mostly empty. Skis can also be carried laterally with straps on the sides.

Ref.	Product name	Capacity	Weight		X-PRESS	SEARCH TRACK	H ₂ O	ICE AXE	POLES	HELMET	SHOVEL	PROBE	CRAMPONS	
			g	oz										
3147	SKI RAPTOR 30	30 L	930	32.8	X-Press	•	•	•	•	•	•	•	•	2

SKI RAPTOR 20

3146

SKI MOUNTAINEERING



3 Forest Green



4 Black



Video

- Made from durable 420D nylon
- X-Press ski carrying system with Tubular Rewind allows skis to be attached and removed without removing the pack
- The tail loop for the X-Press ski carrying system can be set in two positions making it easy to insert skis whether the pack is fully loaded or mostly empty
- Skis can also be carried laterally with fast buckle attachments
- Side entry crampon pocket is easily accessed without removing the pack and can be zipped open from the inside to connect to the main compartment
- Dual hide-away ice axe carriers with sleeves to enclose the picks and aluminum plates that thread through the head of the tools at the bottom and removeable straps at the top
- Hide-away system for carrying poles
- Hide-away elastic mesh helmet carrying system can be removed when not in use
- Dedicated fast access compartment on the front for shovel and probe with inner zipper pocket
- Ergonomic and ventilated back panel with a wide Full BackDoor opening and a sleeve pocket for a hydration bladder
- Padded shoulder straps feature external edging for greater comfort
- Waist belt is equipped with elastic pockets on both sides and a gear loop on the right hip
- Height adjustable chest strap
- Top zip pocket
- Top handle for easy transport
- Hydration compatible

The 20-liter version of the Ski Raptor is designed for lighter, faster freeride missions. The Ski Raptor 20 builds on our years of designing purpose-built packs for specific adventures. Utilizing design features from our benchmark skimo race packs, the Ski Raptor 20 is a truly unique freeride pack. Constructed from 420D ripstop nylon for incredible durability. Ventilated back panel and external edging on the shoulder straps for increased comfort. Other popular features remain like the X-Press ski carrying system that allows skis to be attached and removed without removing the pack, Full BackDoor access that makes gear accessible independent of where it is layered in the pack, hide-away and removable systems for carrying essential gear like poles, axes and helmet, and a dedicated side entry crampon compartment. The Ski Raptor 20 now also includes a dedicated fast access pocket on the front for shovel and probe. The tail loop for the X-Press ski carrying system can be set in two positions making it easy to insert skis whether the pack is fully loaded or mostly empty. Skis can also be carried laterally with straps on the sides.

Ref.	Product name	Capacity	Weight		X-PRESS	Basic Board	H ₂ O	Ice Axe	Probe	Shovel	Hydration	Ski
			g	oz								
3146	SKI RAPTOR 20	20 L	790	27.9	X-Press	•	•	•	•	•	•	2

SUMMIT 30

3299

1ST CLASS

SKI MOUNTAINEERING, ALPINISM



1 Anthracite Grey



2 Blue



- Made from lightweight and durable 100D triple ripstop nylon
- Side ski carrying system with hide-away straps with fast clip buckles
- Crampon pocket with side zipper opening can be accessed without removing the pack and can be zipped open from the inside to connect to the main compartment
- Dual hide-away ice axe carriers with sleeves to enclose the picks and aluminum plates that thread through the head of the tools at the bottom and removeable straps at the top
- Ergonomic and ventilated back panel with a wide Full BackDoor opening and a sleeve pocket for a hydration bladder
- Padded shoulder straps with external edging for greater comfort
- Waist belt with zippered elastic pocket on the right and gear loop on the left
- Height adjustable chest strap
- Inner elastic pockets for small items and accessories
- Dedicated fast access pocket on the front for shovel and probe
- Elasticized front pocket for storing wet items like skins or layers
- Side pockets with elastic on the interior and magnet closures for storing items
- Roll top lid with internal drawstring closure
- Hide-away elastic mesh helmet carrying system can be removed when not in use
- Top handle for easy transport
- Hydration compatible

The Summit 30 is designed with mountains in mind. It combines the best features from our alpine and skimo packs for a singular result that makes the Summit 30 a technical marvel for ski mountaineering. 100D triple ripstop nylon fabric is strong and lightweight. The dedicated fast access pocket for probe and shovel along with the side entry crampon pocket that can be accessed without removing the pack and the Full BackDoor opening characterize the skimo features of the Summit 30. The strong and secure A-Frame ski carrying straps, dual technical ice axe carriers, external helmet carrying system, roll top lid and gear loop on the hip belt characterize the alpine features. Combined into a single pack, the Summit 30 is a ski mountaineering pack that is purpose built for ski mountaineering in technical terrain.

PACKS

Ref.	Product name	Capacity	Weight		X PRESS	SHOCK CORNER	H ₂ O	ICE AXE	CAMP	SHOVEL	SPOON	HYDRATION	SKI
			g	oz									
3299	SUMMIT 30	30 L	1090	38.5	Lateral	•	•	•	•	•	•	•	1



TRAIL FORCE 20

3100

RAID RACING

- Constructed from stretch-resistant durable polyester with water repellent treatment
- Shoulder straps and back constructed from soft and very lightweight 3D mesh
- Soft back with thin perforated padding to enhance breathability
- Soft edging for great comfort against the body
- 2 Soft Flask holders on the shoulder straps are compatible with the SF 300 and 600 and utilize bungee cords to hold bottles in place when they are not full
- 2 wide pockets for gloves and accessories on the shoulder straps
- Main back compartment is easily accessible from the top
- Elastic cord load compression system
- Internal pocket with key holder and sleeve for hydrobag or layers to be kept separate
- External elastic mesh pockets
- Front closure system with straps and fast buckles is height adjustable
- Easy and fast lateral width adjustment system with elastic
- Innovative trekking poles holder derived from the X-Press ski carrying system on our ski mountaineering packs allow poles to be attached and detached while running without removing the pack
- Back loops for trekking poles holder, racing bib, signal chip, or safety lamp
- Hydration compatible
- Available in 2 sizes for optimal fit: S (150-170 cm), L (175-195 cm)

The Trail Force 20 completes our range of trail packs with a product specifically designed for multi-day races where we have to carry more gear. The Trail Force 20 uses the same construction and design concept as the other Trail Force models for the same functionality, comfort and lightweight. As a vest, it is also a valid alternative to classic hiking backpacks with similar capacities and is far superior to a standard backpack when running or scrambling. Balance is one of the keys to stability and the Trail Force 20 has been studied for optimal balance with front pockets that hold both hydration and food as well as essential gear so that all of the gear does not bulk up only the back of the pack. Pockets are intentionally positioned both on the inside and outside to the pack for optimal organization and fast access to gear. The innovative trekking pole carrying system is derived from the X-Press ski carrying system on our ski mountaineering backpacks. It allows the poles to be attached and removed without stopping or removing the pack. The system uses elastic cords that are fixed to the poles that can then be captured by a carabiner (included). Once the poles are clipped together, the carabiner gets clipped to a loop on the back left-side of the pack and then the tips of poles get captured by the X-Press strap on the right shoulder for a very secure and fast attachment.



Ref.	Product name	Capacity	Sizes	Person		Waist		Weight		Hydration	Trekking Poles
				h (cm)	h (in)	cm	in	g	oz		
3100	TRAIL FORCE 20	20 L	XS-M	150-175	59.1-68.9	69-85	27.2-33.5	420	14.8	•	
			M-L	175-195	68.9-76.8	85-115	33.5-45.3	458	16.2		



TRAIL FORCE 10

3099

TRAIL RUNNING, RAID RACING

- Upper part constructed from 2-way stretch fabric that is superlight, water repellent and fast drying
- Lower part constructed from soft, breathable, lightweight elastic mesh
- Shoulder straps and back constructed from soft and very lightweight 3D mesh
- Soft edging for great comfort against the body
- Zippered pocket for mobile phone on the right shoulder strap
- Zippered pocket for accessories (gels, keys, etc.) on the left shoulder strap
- 2 Soft Flask holders on the shoulder straps are compatible with the SF 300 and 600 and utilize bungee cords to hold bottles in place when they are not full
- 2 wide pockets for gloves and accessories on the shoulder straps
- Main back compartment is easily accessible from the top
- Practical back pocket with elastic closures instead of zippers or Velcro allows for storing and accessing layers without removing the pack
- Side zipper pockets
- Innovative fast front closure system with cordlock and elastic cords for optimal stability
- Functional and fast side adjustments for a fine-tuned fit
- Innovative trekking poles holder derived from the X-Press ski carrying system on our ski mountaineering packs allow poles to be attached and detached while running without removing the pack
- Back loops for trekking poles holder, racing bib, signal chip, or safety lamp
- Hydration compatible
- Available in 2 sizes for optimal fit: S (150-170 cm), L (175-195 cm)

The completely updated Trail Force 10 increases the volume to 10 liters for longer outings in more variable conditions. Like the Trail Force 5, the Trail Force 10 is designed to carry all the necessary gear and hydration in the most ergonomic way. The vest is formed with enough material to create enough surface contact with the body to limit movement while running. The main compartment and all accessory compartments feature compression materials to limit load shifting. Soft, ventilated, moisture-wicking 3D mesh combines with super soft edging material anywhere the vest comes in contact with the body for superior comfort even on bare skin. The main front closure combines with elasticized adjustability on the sides to fine-tune the fit. The innovative trekking pole carrying system is derived from the X-Press ski carrying system on our ski mountaineering backpacks. It allows the poles to be attached and removed without stopping or removing the pack. The system uses elastic cords that are fixed to the poles that can then be captured by a carabiner (included). Once the poles are clipped together, the carabiner gets clipped to a loop on the back left-side of the pack and then the tips of poles get captured by the X-Press strap on the right shoulder for a very secure and fast attachment.



Ref.	Product name	Capacity	Sizes	Person		cm		Weight		H ₂ O	Bottle
				h (cm)	h (in)	cm	in	g	oz		
3099	TRAIL FORCE 10	10 L	XS-M	150-175	59.1-68.9	69-85	27.2-33.5	189	6.7	•	
			M-L	175-195	68.9-76.8	85-115	33.5-45.3	200	7.1		



TRAIL FORCE 5

3098

TRAIL RUNNING

- Upper part constructed from 2-way stretch fabric that is superlight, water repellent and fast drying
- Lower part constructed from soft, breathable, lightweight elastic mesh
- Shoulder straps and back constructed from soft and very lightweight 3D mesh
- Soft edging for great comfort against the body
- Zippered pocket for mobile phone on the right shoulder strap
- Zippered pocket for accessories (gels, keys, etc.) on the left shoulder strap
- 2 Soft Flask holders on the shoulder straps are compatible with the SF 300 and 600 and utilize bungee cords to hold bottles in place when they are not full
- 2 wide pockets for gloves and accessories on the shoulder straps
- Main back compartment is easily accessible from the top
- Practical back pocket with elastic closures instead of zippers or Velcro allows for storing and accessing layers without removing the pack
- Side zipper pockets
- Innovative fast front closure system with cordlock and elastic cords for optimal stability
- Functional and fast side adjustments for a fine-tuned fit
- Innovative trekking poles holder derived from the X-Press ski carrying system on our ski mountaineering packs allow poles to be attached and detached while running without removing the pack
- Back loops for trekking poles holder, racing bib, signal chip, or safety lamp
- Hydration compatible
- Available in 2 sizes for optimal fit: S (150-170 cm), L (175-195 cm)

The Trail Force 5 has been completely updated in collaboration with Franco Collé and Giuditta Turini, the 'golden couple' of the Italian trail. It is a hyperlight form-fitting running vest that has been purpose built for sky running races and light and fast missions where having the right gear and enough hydration is critical, but not knowing you're carrying it is essential. The vest is formed with enough material to create enough surface contact with the body to limit movement while running. The main compartment and all accessory compartments feature compression materials to limit load shifting. Soft, ventilated, moisture-wicking 3D mesh combines with soft edging material anywhere the vest comes in contact with the body for superior comfort even on bare skin. The main front closure combines with elasticized adjustability on the sides to fine-tune the fit. The innovative trekking pole carrying system is derived from the X-Press ski carrying system on our ski mountaineering backpacks. It allows the poles to be attached and removed without stopping or removing the pack. The system uses elastic cords that are fixed to the poles that can then be captured by a carabiner (included). Once the poles are clipped together, the carabiner gets clipped to a loop on the back left-side of the pack and then the tips of poles get captured by the X-Press strap on the right shoulder for a very secure and fast attachment.

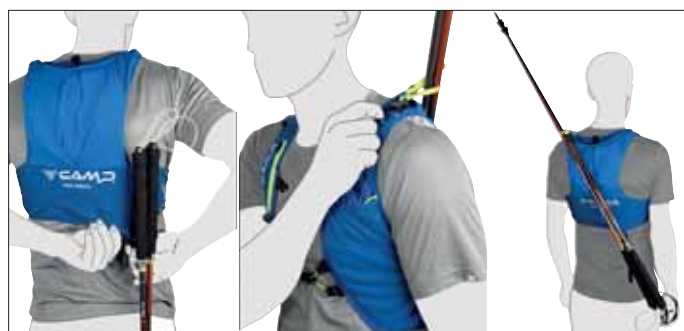

Ref.	Product name	Capacity	Sizes	Person		Shorts		Weight		H ₂ O	Bottle
				h (cm)	h (in)	cm	in	g	oz		
3098	TRAIL FORCE 5	5 L	XS-M	150-175	59.1-68.9	69-85	27.2-33.5	168	5.9	•	
			M-L	175-195	68.9-76.8	85-115	33.5-45.3	177	6.2		



TRAIL FORCE 2

3097

LIGHT&FAST

TRAIL RUNNING

- Upper part constructed from 2-way stretch fabric that is superlight, water repellent and fast drying
- Lower part constructed from soft, breathable, lightweight elastic mesh
- Shoulder straps and back constructed from soft and very lightweight 3D mesh
- Soft edging for great comfort against the body
- Zippered pocket for mobile phone on the right shoulder strap
- Zippered pocket for accessories (gels, keys, etc.) on the left shoulder strap
- 2 Soft Flask holders on the shoulder straps are compatible with the SF 300 and 600 and utilize bungee cords to hold bottles in place when they are not full
- 2 wide pockets for gloves and accessories on the shoulder straps
- Main back compartment is easily accessible from the top
- Practical back pocket with elastic closures instead of zippers or Velcro allows for storing and accessing layers without removing the pack
- Side zipper pockets
- Innovative fast front closure system with cordlock and elastic cords for optimal stability
- Functional and fast side adjustments for a fine-tuned fit
- Innovative trekking poles holder derived from the X-Press ski carrying system on our ski mountaineering packs allow poles to be attached and detached while running without removing the pack
- Back loops for trekking poles holder, racing bib, signal chip, or safety lamp
- Hydration compatible
- Available in 2 sizes for optimal fit: S (150-170 cm), L (175-195 cm)

Even more compact, lighter weight and more streamlined than the Trail Force 5, the Trail Force 2 accommodates the essentials for training sessions and shorter races. Organization is the key in a vest pack like this. The numerous pockets allow for immediate access to hydration, food and other accessories. Soft, ventilated, moisture-wicking 3D mesh combines with soft edging material anywhere the vest comes in contact with the body for superior comfort even on bare skin. The innovative trekking pole carrying system is derived from the X-Press ski carrying system on our ski mountaineering backpacks. It allows the poles to be attached and removed without stopping or removing the pack. The system uses elastic cords that are fixed to the poles that can then be captured by a carabiner (included). Once the poles are clipped together, the carabiner gets clipped to a loop on the back left-side of the pack and then the tips of poles get captured by the X-Press strap on the right shoulder for a very secure and fast attachment.

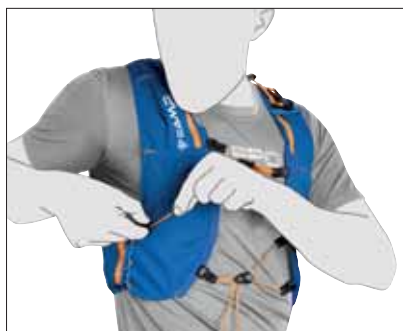

Ref.	Product name	Capacity	Sizes	Person		Vest		Weight		Hydration	Bottle
				h (cm)	h (in)	cm	in	g	oz		
3097	TRAIL FORCE 2	2 L	XS-M	150-175	59.1-68.9	69-85	27.2-33.5	159	5.6	•	
			M-L	175-195	68.9-76.8	85-115	33.5-45.3	164	5.8		

OUTBACK 20

3348

TRAIL RUNNING, HIKING



1 Blue



2 Black



3 Lime

- Constructed from lightweight, durable polyester fabric with water repellent treatment
- Ventilated back reduces contact with the body thanks to the two tensioned bands of soft breathable mesh
- Padded hip belt is integrated into the ventilation system and has 2 elastic zippered pockets
- Ergonomic shoulder straps for exceptional comfort
- Load adjustment straps for advancing the load onto the shoulders
- Main compartment with large zip opening
- Upper front zippered pocket with internal key holder
- Large lower front zippered pocket in elastic mesh
- Elastic mesh external side pockets with reinforced bottoms
- External load compression system can also be used to carry extra gear
- Slot for safety lamp
- Trekking poles holder
- Hydration compatible

The Outback 20 is a very compact, lightweight, versatile pack designed for multisport missions. It is great for fast packing on foot, scrambling, skiing or cycling. 20 liter capacity in the main compartment is augmented by the fast access elastic pockets on the sides. The load compression bungee straps allow layers to be cinched to the outside of the pack and tighten down to help with load shift and distribution when the pack is not full. The ventilated back is constructed from two soft tensioned bands of breathable mesh to reduce the contact area with the body and the separation creates a very comfortable channel for air flow. The padded hip belt is integrated into the ventilation system on the back to help position it for optimal comfort and air flow.

OUTBACK 5

3105

TRAIL RUNNING, HIKING



1 Light Blue





2 Black



3 Lime

- Soft mesh with breathable EVA padding on the back and shoulder straps
- Bungee load compression straps
- External zip security pocket
- Elastic side pockets for extra capacity
- Trekking poles holder
- Hydration compatible

The Outback 5 is a multisport 5 liter pack for fast and light missions. It carries well for running, hiking, biking and on skis. The 5 liter main compartment is hydration compatible and the two exterior mesh pockets allow for easy access and extra capacity. Bungee load compression straps can also be used to strap on layers when not in use. The main compartment can also accommodate a low profile snow shovel and probe.

Ref.	Product name	Capacity	Weight			
			g	oz		
3348	OUTBACK 20	20 L	950	33.5	•	•
3105	OUTBACK 5	5 L	270	9.5	•	•



SC 200

2594 200 ml - 11 g

TRAIL RUNNING, HIKING

- Soft and compressible 200 ml cup
- PVC and BPA free
- Features a reinforced edge and rubber clipping ring

Super light, soft and compressible cup designed to limit the use of throw-away plastic cups at hydration points during races. When not in use the cup compresses flat for carrying in a pack or a pocket. It can also be clipped off with the rubber ring that also serves as a small handle.



SF

2592 300 ml - 33 g

2593 600 ml - 44 g

TRAIL RUNNING, HIKING

- Soft and compressible flask bottles for active hydration
- PVC and BPA free
- Available in 2 sizes: 300 ml/10 oz and 600 ml/20 oz
- The 600 ml version comes equipped with a tube
- Sold individually

The SF Soft Flask is a direct response to mountain athletes who want access to hydration carried close to the body, but without the bulk of traditional bottles or the volume of large bladders. Their flexible construction allows them to mold to the position in which they are being carried and they compress as they are emptied to take up less space in the pack. The special bite valve ensures quick and easy access to the contents. The SF is constructed from Thermoplastic Polyurethane (TPU) that is tasteless and completely free of PVC and BPA so they meet or exceed US FDA and EC regulations. The 600 ml version is equipped with a tube making it ideal for carrying on the shoulder strap of a running pack.



SF HOLDER

3464 26 g

NEW

TRAIL RUNNING, HIKING

- Holder for carrying the SF 600 ml soft flask designed to attach to the shoulder straps on most packs
- Sold individually

Elastic mesh holder that attaches with Velcro straps to the shoulder straps on most packs, designed to carry the SF soft flask. SF 600 not included.



ACTION BOTTLE

1794 0.75 L - 100 g

HIKING, LIFESTYLE

- 0.75 Liter Capacity

A lightweight water bottle for hiking and lifestyle.



BOTTLE HOLDER - 2 pcs

2137 62 g - 2 pcs

TRAIL RUNNING, HIKING

- Sold in pairs

Water bottle holders designed to attach to the shoulder straps on packs. Sold in pairs. A bungee ring secures the bottle to the holster when running. Bottles not included. Pouches on the sides for carrying gels.



A magic night in the Cordillera Real in the Bolivian Andes
© Giacomo Meneghello

ESSENTIAL LINE



ESSENTIAL LINE

Leave no gear behind. The Essential Line is a group of products that are so light and so compact that you eventually run out of excuses not to carry these necessary pieces of gear with you in the backcountry. The C.A.M.P. Research & Development team was tasked with trimming all discretionary features to distill these products down to the very best in four key areas: lightweight, packability, performance and functionality. By carrying Essential products (a complete line with outerwear, tents, sleeping bags, mats and packs) you have at your disposal, ready to protect you, the right gear when conditions unexpectedly turn critical as so often happens in the mountains.

Essential is more than a product line. It is a demanding philosophy that drives the development of gear for those who want only the best. With the Essential approach, C.A.M.P. works tirelessly to reduce weight, increase packability and simplify every detail to achieve more streamlined performance. The Minima tent series now features different models in one, two and three-person versions; they are extremely compact making them the right choice for multi-day adventures. For lovers of lightweight packability, we have also developed the Ghost and Phantom packs that compress into tiny compartments when not in use, but fold out to full 15 liter fast packs with all the features and systems for carrying essential gear.

Insulation for any occasion. C.A.M.P. has a long experience with down insulation from our years developing high-end sleeping bags. This has been the key to our fast and furious development of Essential insulated garments that have grown in popularity by leaps and bounds since their introduction several years ago. The line today features a wide range of models that use down and synthetic insulation in combination with exterior fabrics that give Essential garments unparalleled properties of warmth versus weight.



RDS certificate: responsible sourcing of down



C.A.M.P. supports the Responsible Down Standard in its use of down and feathers. The down and feathers used for insulation in consumer products is sourced from worldwide production and processing supply chains. The goal of the Responsible Down Standard is to ensure that the waterfowl in the down supply chain are treated humanely. This is accomplished by providing the industry with the best possible tool to ensure that down and feathers do not come from animals that have been subjected to any unnecessary harm and to institute a chain of custody system to validate the source of the material. At the same time as helping to improve the welfare of animals, the Responsible Down Standard provides retailers and consumers alike with greater confidence in responsible sourcing.

DWR C0 (PFC Free) treatment for C.A.M.P. products



The DWR (Durable Water Repellent) treatment ensures the water repellency of a fabric by making drops of water that come in contact with the treated fabric slide off the surface without impregnating it. C.A.M.P. has adopted a C0 DWR treatment that guarantees zero use of fluorocarbons (PFC free). This is an advantage both for the health of the environment and the user. C0 is already used on all items of apparel and will also be used on future production of sleeping bags.

CATEGORY LEADERS



1ST CLASS
BREVA JACKET
3312



LIGHT&FAST
VERTEX JACKET
3406



LIGHT&FAST **BEST SELLER**
ED 150
2731



1ST CLASS
MINIMA 2 EVO
3232



LIGHT&FAST
MINIMA 1 SL
2392

Essential Materials

DISCOVER THE MATERIALS THAT MAKE OUR OUTERWEAR UNIQUE



DOWN: down insulation remains the best insulation material in terms of weight v. warmth. NN/NN indicates the percentage of down and feathers by weight (for example 90/10 means 90% down and 10% feathers). Fill Power measures the ability of the down to loft and fill space thereby providing insulation; generally, the higher the fill power rating, the better the quality and insulation value of the down. The ED Line uses both goose and duck down, depending on the model. Goose down has the highest loft so it is the best in terms of weight v. volume. Duck down has less loft, but is notable for its durability and ability to rebound without losing performance over time.



PRIMALOFT® BLACK RISE: 100% recycled polyester insulation engineered to deliver a full spectrum of benefits. Millions of air pockets trap body heat for excellent insulation and the lack of bulk means great freedom of movement. The PrimaLoft® hydrophobic treatment ensures that it will continue to insulate even when it is wet. PrimaLoft® strikes a near perfect blend as a lightweight insulator for active applications in variable conditions.

HITEX EVO

HITEX EVO: a lightweight and very strong Nylon Ripstop fabric with a DWR (Durable Water Repellent) treatment on the exterior and a special interior coating that makes the fabric waterproof and breathable. It also features an anti-stain treatment.

NIVIX EVO

NIVIX EVO: an amazingly strong and durable Ripstop Nylon fabric for the most technical activities. Nivix Evo features a mixed construction that delivers an optimal blend of strength, durability and lightweight. Downproof by design, it also features a DWR (Durable Water Repellent) treatment on the exterior and an inner coating that makes the fabric waterproof and breathable.

FLOWTEX

FLOWTEX: Nylon ripstop fabric that is extremely soft and pleasant to the touch. It has a DWR (Durable Water Repellent) treatment on the exterior and a special interior coating that makes the fabric waterproof and breathable. It contributes to the comfort and compactibility for jackets and garments that are designed to be worn while on the move.

FLEXTEX

FLEXTEX 2.0: an elasticized softshell fabric that delivers a performance fit with great freedom of movement. Lightweight and durable, it is an ideal material for technical layering and outer pieces.

T-LITE

T-LITE: a lightweight, breathable Nylon fabric that is calendered* to be down proof without the use of coatings. It is used as the liner of choice for all of our essential winter garments.

* **CALENDERING:** a finishing process where the fabric is pressed under heated rollers. The process makes the fabric more durable, windproof and downproof.

CARE AND MAINTENANCE. The unique features of Essential Outerwear are best maintained over time by following these basic rules: hand wash in lukewarm water using a delicate soap; don't rub, squeeze, or wring out garments; allow to dry completely in a well-ventilated space. For more details, please refer to the washing instructions on each product.

Ref.	Product name	Sizes	Weight			Exterior Fabrics	Filling: Down			Filling: PrimaLoft®		Hood	Cut
			Size	g	oz		Type	Filling Power (cuin)	Average weight (g)	Type	Weight (g/m²)		
3305	NIVIX JACKET 2.0	XS-S-M L-XL-XXL	M	725	25.6	Nivix Evo	90/10 White Duck Down R.D.S.	750	190			Technical	Regular Fit
3306	NIVIX LIGHT JACKET	S-M-L XL-XXL	M	450	15.9	Flowtex	90/10 White Duck Down R.D.S.	750	130			Classic	Slim Fit
3308	HYPER JACKET	S-M-L XL-XXL	M	480	16.9	Hitex Evo	90/10 White Duck Down R.D.S.	750	150			Technical	Regular Fit
3309	PROTECTION JACKET	S-M-L XL-XXL	M	445	15.7	Hitex Evo	90/10 White Duck Down R.D.S.	750	150			Technical	Slim Fit
3404	JOKER JACKET	S-M-L XL-XXL	M	430	15.2	Flowtex	80/20 White Duck Down R.D.S.	600	25	PrimaLoft® Black Rise	80	Classic	Regular Fit
3312	BREVA JACKET	S-M-L XL-XXL	M	465	16.4	Flowtex	80/20 White Duck Down R.D.S.	600	50	PrimaLoft® Black Rise	40	Technical	Regular Fit
3313	HYBRID JACKET	S-M-L XL-XXL	M	425	15.0	Hitex Evo / FlexTex 2.0	80/20 White Duck Down R.D.S.	600	50	PrimaLoft® Black Rise	80 / hood: 40	Classic	Slim Fit
3314	HYBRID VEST	S-M-L XL-XXL	M	275	9.7	Hitex Evo / FlexTex 2.0	80/20 White Duck Down R.D.S.	600	25	PrimaLoft® Black Rise	80		Slim Fit
3406	VERTEX JACKET	S-M-L XL-XXL	M	365	12.9	Hitex Evo				PrimaLoft® Black Rise	80 / hood, back: 40	Classic	Slim Fit
3316	ADRENALINE JACKET 3.0	XS-S-M L-XL	M	380	13.4	Hitex Evo				PrimaLoft® Black Rise	80	Foldable	Slim Fit
3317	ADRENALINE PANT 3.0	XS-S-M L-XL	M	350	12.4	Hitex Evo / Elastic Fabric				PrimaLoft® Black Rise	40		Slim Fit
3307	NIVIX LIGHT JACKET LADY	XS-S-M L-XL	S	390	13.8	Flowtex	90/10 White Duck Down R.D.S.	750	130			Classic	Slim Fit
3310	PROTECTION JACKET LADY	XS-S-M L-XL	S	355	12.5	Hitex Evo	90/10 White Duck Down R.D.S.	750	130			Technical	Slim Fit
3315	HYBRID JACKET LADY	XS-S-M L-XL	S	350	12.4	Hitex Evo / FlexTex 2.0	80/20 White Duck Down R.D.S.	600	50	PrimaLoft® Black Rise	80 / hood: 40	Classic	Slim Fit
3318	BURAN JACKET LADY	XS-S-M L-XL	S	315	11.1	Hitex Evo	80/20 White Duck Down R.D.S.	600	30	PrimaLoft® Black Rise	80	Technical	Regular Fit

Fit Guide

Slim Fit

- Waist-fitted cut
- Can be worn as an insulating or outer layer

Regular Fit

- Classic cut
- For use as an outer layer with a more spacious fit than the Slim Fit

SLIM FIT

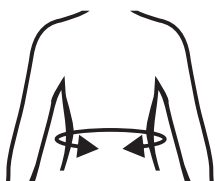

Nivix Light Jacket / Nivix Light Jacket Lady
Protection Jacket / Protection Jacket Lady
Adrenaline Jacket 3.0
Hybrid Jacket / Hybrid Jacket Lady / Hybrid Vest
Vertex Jacket

REGULAR FIT

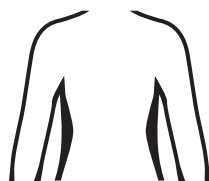

Nivix Jacket 2.0
Hyper Jacket
Joker Jacket
Brevia Jacket
Buran Jacket Lady

Size Chart

Measurements refer to body size, not to garment size.

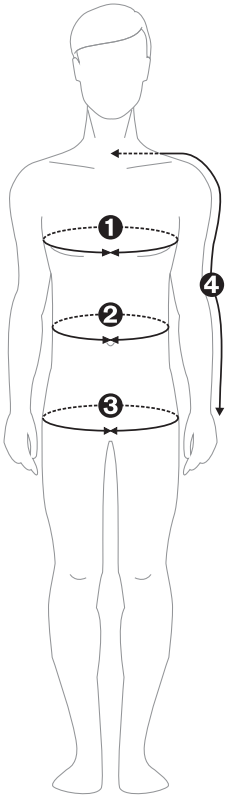

MEN												
Size	XS		S		M		L		XL		XXL	
	cm	in	cm	in	cm	in	cm	in	cm	in	cm	in
1. Chest	88-91	34.6-35.8	92-95	36.2-37.4	96-99	37.7-38.9	100-103	39.3-40.5	104-107	40.9-42.1	108-111	42.5-43.7
2. Waist	76-79	29.9-31.1	80-83	31.4-32.6	84-87	33-34.2	88-91	34.6-35.8	92-95	36.2-37.4	96-99	37.7-38.9
3. Hip	92-95	36.2-37.4	96-99	37.7-38.9	100-103	39.3-40.5	104-107	40.9-42.1	108-111	42.5-43.7	112-115	44-45.2
4. Arm	79	31.1	81	31.9	83	32.7	85	33.5	87	34.3	89	35.0

MEN - Measurement points

1. Measure around the widest part of your chest, keeping the tape snug and level under your arms and across your back.
2. Measure around the narrowest part of your waist.
3. Measure around the widest part of your hips.
4. Measure sleeve length from the center back of your neck, across your shoulder over the bent elbow, to the center of the wrist bone.

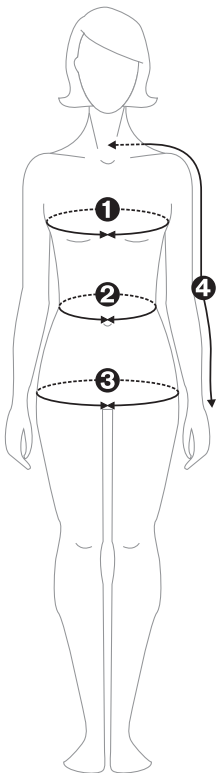

WOMEN											
Size	XS		S		M		L		XL		
	cm	in	cm	in	cm	in	cm	in	cm	in	
1. Breast	86-89	33.8-35	90-93	35.4-36.6	94-97	37-38.1	98-101	38.5-39.7	102-105	40.1-41.3	
2. Waist	62-65	24.4-25.5	66-69	25.9-27.1	70-73	27.5-28.7	74-77	29.1-30.3	78-81	30.7-31.8	
3. Hip	90-93	35.4-36.6	94-97	37-38.1	98-101	38.5-39.7	102-105	40.1-41.3	106-109	41.7-42.9	
4. Arm	75	29.5	77.5	30.5	79	31.1	80.5	31.7	83	32.7	

WOMEN - Measurement points

1. Measure around the widest part of your bust, keeping the tape level under your arms and across your back.
2. Measure around the narrowest part of your waist.
3. Measure around the widest part of your hips.
4. Measure sleeve length from the center back of your neck, across your shoulder over the bent elbow, to the center of the wrist bone.

ESSENTIAL WINTER OUTERWEAR

Men



NIVIX JACKET 2.0
3305



NIVIX LIGHT JACKET
3306



HYPER JACKET
3308



PROTECTION JACKET
3309



JOKER JACKET
3404



BREVA JACKET
3312



HYBRID JACKET
3313



HYBRID VEST
3314



VERTEX JACKET
3406



ADRENALINE JACKET 3.0
3316



ADRENALINE PANT 3.0
3317

Women



NIVIX LIGHT JACKET LADY
3307



PROTECTION JACKET LADY
3310



HYBRID JACKET LADY
3315



BURAN JACKET LADY
3318



2 Asphalt Grey / Asphalt Grey



1 Black / Lime Punch

6 Blue / Lime



7 Mojito Green / Asphalt Grey



NIVIX JACKET 2.0

3305

ALPINISM, SKI MOUNTAINEERING, MOUNTAINEERING, ALPINE SKIING, LIFESTYLE

- Premium-grade white duck down with 750+ fill power
- Nivix Evo nylon ripstop fabric is water repellent, breathable and super strong
- T-Lite fabric lining
- Full-size fixed hood with visor fits over a helmet
- Full-length YKK® zipper with anti-jam system
- 2 zippered external side pockets
- Zippered outer chest pocket
- 2 large inner pockets and a small phone pocket
- Ski pass pocket on the left sleeve
- Stuff sack
- Elasticized waist
- Zippered armpits for additional ventilation
- Elasticized windproof cuffs with thumb holes
- Elasticized sides for comfort and mobility
- Regular Fit

The Nivix Jacket 2.0 uses a robust exterior fabric and extra insulation to make it tougher and warmer for alpine skiing. 190 grams of premium-grade white duck down with 750+ fill power combine with the Nivix Evo ripstop nylon fabric that is both breathable and water repellent. We have designed this jacket for the coldest active alpine conditions, from first tracks and icy ski runs to alpine walls and long couloirs. Alpinists in particular will appreciate the strength and durability of the Nivix Evo fabric while skiers will love the extra bit of insulation and the stretch panels on the sides that keep the jacket snug to the body but still free for dynamic movement. The small pocket on the lower left sleeve is designed to carry a ski pass, climbing topos or other accessories.

Ref.	Product name	Sizes	Weight			Exterior Fabrics	Filling: Down			Hood	Cut
			Size	g	oz		Type	Filling Power (cuin)	Average weight (g)		
3305	NIVIX JACKET 2.0	XS-S-M-L XL-XXL	M	725	25.6	Nivix Evo	90/10 White Duck Down R.D.S.	750	190	Technical	Regular Fit



2 Blue / Blue



1 Asphalt Grey / Asphalt Grey

4 Black / Lime

5 Mojito Green / Asphalt Grey



NIVIX LIGHT JACKET

3306

SKI MOUNTAINEERING, ALPINE SKIING, ALPINISM, MOUNTAINEERING, LIFESTYLE

- Premium-grade white duck down with 750+ fill power
- Flowtex nylon ripstop fabric is extremely soft and pleasant to the touch, with a DWR treatment
- T-Lite fabric lining
- Full-size fixed hood with visor fits over a helmet
- Full-length YKK® zipper with anti-jam system
- 2 zippered external side pockets
- 2 large inner pockets
- Ski pass pocket on the left sleeve
- Stuff sack
- Adjustable waist with elastic cord
- Elasticized windproof cuffs
- Elasticized sides for comfort and mobility
- Slim Fit

The Nivix Light Jacket is a lighter version of the popular Nivix 2.0. It combines soft and supple Flowtex nylon ripstop fabric on the exterior with premium-grade white duck down (750 cuin) insulation for a fit and feel that is naturally pleasant.

HYPER JACKET

3308

ALPINISM, SKI MOUNTAINEERING, MOUNTAINEERING, LIFESTYLE



1 Night Blue / Lime Punch



4 Asphalt Grey / Asphalt Grey

5 Kiwi Green / Blue

- Premium-grade white duck down with 750 fill power
- Hitex Evo ripstop nylon shell is light, strong, and still highly weather resistant with a DWR treatment
- T-Lite fabric lining
- Technical adjustable hood
- 2 zippered inner chest pockets
- Full-length YKK® zipper with anti-jam system
- 2 zippered external pockets positioned to allow access while wearing a pack and harness
- 2 large inner elasticized pockets
- Stuff sack
- Adjustable waist with elastic cord
- Elasticized windproof cuffs
- Regular Fit

The Hyper Jacket features construction that is designed for comfort with a new channel design. It delivers the same protection from cold that C.A.M.P. jackets are known for with 150 grams of 750 fill power premium-grade white duck down combined with a profiled fit and elasticized windproof cuffs for optimal thermal insulation and excellent comfort and mobility.

Ref.	Product name	Sizes	Weight			Exterior Fabrics	Filling: Down			Hood	Cut
			Size	g	oz		Type	Filling Power (cuin)	Average weight (g)		
3306	NIVIX LIGHT JACKET	S-M-L XL-XXL	M	450	15.9	Flowtex	90/10 White Duck Down R.D.S.	750	130	Classic	Slim Fit
3308	HYPER JACKET	S-M-L XL-XXL	M	480	16.9	Hitex Evo	90/10 White Duck Down R.D.S.	750	150	Technical	Regular Fit

PROTECTION JACKET

3309

BEST SELLER

ALPINISM, SKI MOUNTAINEERING, MOUNTAINEERING, LIFESTYLE



10 Stone Grey / Black / Stone Grey



1 Black / Asphalt Grey

2 Night Blue / Lime Punch



7 Asphalt Grey / Lime

8 Kiwi Green / Lime Punch



9 Kiwi Green / Asphalt Grey / Asphalt Grey



- Premium-grade white duck down with 750+ fill power
- Hitex Evo ripstop nylon shell is light, strong, and still highly weather resistant with a DWR treatment
- T-Lite fabric lining
- Full-size hood is fixed and fits over a helmet
- Full-length YKK® zipper with anti-jam system
- 2 zippered external side pockets
- Zippered outer chest pocket
- 2 large inner pockets and a small phone pocket
- Stow-Away Pocket
- Adjustable waist with elastic cord
- Elasticized windproof cuffs
- Elasticized sides for comfort and mobility
- Slim Fit

The best seller of the Essential Line is updated with a new channel design for better comfort and technical performance. The adjustable waist and elasticized windproof cuffs provide a tight thermal seal so the premium-grade white duck down insulation (750 cuin fill power) can do its job. The Hitex Evo shell is lightweight, durable and features a DWR (durable water repellent) treatment for protection from moisture and wind. The fixed hood, internal and external pockets and built-in Stow-Away pocket round out the features on the is technical jacket. The Slim Fit is form-fitting so it can be worn both as an outer layer or as a mid layer.

Ref.	Product name	Sizes	Weight			Exterior Fabrics	Filling: Down			Hood	Cut
			Size	g	oz		Type	Filling Power (cuin)	Average weight (g)		
3309	PROTECTION JACKET	S-M-L XL-XXL	M	445	15.7	Hitex Evo	90/10 White Duck Down R.D.S.	750	150	Technical	Slim Fit



JOKER JACKET

3404

ALPINISM, SKI MOUNTAINEERING, MOUNTAINEERING, LIFESTYLE



3 Mojito Green / Black / Asphalt Grey



1 Asphalt Grey / Black / Asphalt Grey

2 Blue / Black / Blue



4 Black / Black / Black

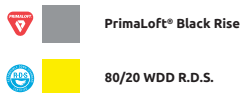

- Dual insulation with down and PrimaLoft® for optimal thermal protection
- Flowtex nylon ripstop fabric is extremely soft and pleasant to the touch, with a DWR treatment
- T-Lite inner fabric
- Technical hood with elasticated edging and rear adjustment
- Full-length YKK® zipper with anti-jam system
- 2 zippered external side pockets
- 1 large inner pocket
- Stow-Away Pocket
- Adjustable waist with elastic cord
- Elasticized windproof cuffs
- Regular Fit

The Joker Jacket is a comfortable, versatile jacket for outdoor activities. It uses soft and comfortable Flowtex fabric with insulation that is distributed for optimal thermal insulation while on the move. The front uses natural duck down (fill power 600 cuin) for the best loft and PrimaLoft® Black Rise 40 g/m² synthetic insulation is used everywhere else so it can continue to insulate the areas that are more prone to getting wet or being compressed.

Ref.	Product name	Sizes	Weight			Exterior Fabrics	Filling: Down			Filling: PrimaLoft®		Hood	Cut
			Size	g	oz		Type	Filling Power (cuin)	Average weight (g)	Type	Weight (g/m ²)		
3404	JOKER JACKET	S-M-L XL-XXL	M	430	15.2	Flowtex	80/20 White Duck Down R.D.S.	600	25	PrimaLoft® Black Rise	80	Classic	Regular Fit



2 Blue / Blue



4 Asphalt Grey / Lime Punch

5 Black / Asphalt Grey

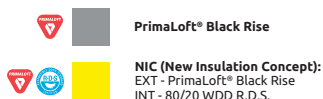

BREVA JACKET

3312

1ST CLASS



ALPINISM, SKI MOUNTAINEERING, MOUNTAINEERING, LIFESTYLE

- Dual insulated jacket with duck down (fill power 600 cuin) and PrimaLoft® Black Rise 40 g/m²
- Innovative NIC construction (New Insulation Concept)
- Flowtex nylon ripstop fabric is extremely soft and pleasant to the touch, with a DWR treatment
- T-Lite inner lining
- Fixed hood with elasticized edging
- Full-length YKK® zipper with anti-jam system
- 2 zippered external side pockets
- 2 external chest pockets with vertical zips
- Stuff sack
- Elasticized waist
- Elasticated windproof cuffs
- Regular Fit

The Brevia Jacket is a technical jacket that combines the benefits of natural down with those of PrimaLoft® synthetic insulation at the highest level. This is made possible with innovative NIC (New Insulation Concept) construction that features a layered combination of the two kinds of insulation. Rather than mixing the insulations, they are actually layered with the down in channeled construction on the inside and the synthetic insulation on the outside to reduce the number of seams and provide the best protection from the elements. Next to body, the user experiences the light, airy, dry warmth of down while the PrimaLoft® Black Rise insulation on the exterior provides a shield from harsh weather and humid conditions. Insulation is also reduced in areas to help regulate body temperature while on the move with the inner down insulation layer removed on the inner sleeves, waist and hood.

Ref.	Product name	Sizes	Weight			Exterior Fabrics	Filling: Down			Filling: PrimaLoft®		Hood	Cut
			Size	g	oz		Type	Filling Power (cuin)	Average weight (g)	Type	Weight (g/m ²)		
3312	BREVA JACKET	S-M-L XL-XXL	M	465	16.4	Flowtex	80/20 White Duck Down R.D.S.	600	50	PrimaLoft® Black Rise	40	Technical	Regular Fit



HYBRID JACKET

3313

ALPINISM, SKI MOUNTAINEERING, LIFESTYLE



2 Blue / Black / Lime



1 Black / Black / Lime

5 Kiwi Green / Black / Lime Punch

6 Stone Grey / Black / Stone Grey

- Dual construction combines the benefits of insulation with a softshell
- Dual insulation with duck down and PrimaLoft® for optimal thermal protection
- The body, hood and external part of sleeves use Hitex Evo fabric
- The sides, inner parts, sleeve panels and waist band use windproof FlexTex 2.0 stretch fabric
- Body front part and sleeves with 600+ fill power duck down insulation
- Body back part with PrimaLoft® Black Rise 80 g/m² that insulates even when wet
- Fixed hood with elasticized edging and PrimaLoft® Black Rise 40 g/m² insulation
- Full-length YKK® zipper with anti-jam system
- 2 zippered external side pockets
- 2 large inner pockets
- Stuff sack
- Elasticized waist
- Elasticized windproof cuffs
- Slim Fit

The Hybrid Jacket, characterized by differentiated construction and insulation, effectively combines the advantages of an insulated jacket and a softshell. The insulated parts ensure good thermal insulation while the parts in stretch fabric ensure freedom of movement and breathability. Thermal performance is increased by the differentiated insulation on the torso and the FlexTex 2.0 fabric. Light and compact, the Hybrid Jacket is a versatile jacket designed for action. It can be used as stand-alone layer with the insulated hood or as a mid layer thanks to the Slim Fit.



PrimaLoft® Black Rise 80 g/m²

PrimaLoft® Black Rise 40 g/m²BI

80/20 WDD R.D.S.



Hitex Evo

FlexTex 2.0

Ref.	Product name	Sizes	Weight			Exterior Fabrics	Filling: Down			Filling: PrimaLoft®		Hood	Cut
			Size	g	oz		Type	Filling Power (cuin)	Average weight (g)	Type	Weight (g/m ²)		
3313	HYBRID JACKET	S-M-L XL-XXL	M	425	15.0	Hitex Evo / FlexTex 2.0	80/20 White Duck Down R.D.S.	600	50	PrimaLoft® Black Rise	80 / hood: 40	Classic	Slim Fit



HYBRID VEST

3314

ALPINISM, SKI MOUNTAINEERING, LIFESTYLE



2 Blue / Black / Lime



1 Black / Black / Lime

5 Kiwi Green / Black / Lime Punch

6 Stone Grey / Black / Stone Gre

- Dual construction combines the benefits of insulation with a softshell
- Dual insulation with duck down and PrimaLoft® for optimal thermal protection
- Hitex Evo fabric with 600+ fill power duck down insulation on the body front part
- PrimaLoft® Black Rise 80 g/m² on the body back part insulates even when wet
- The side panels and waist band use windproof FlexTex 2.0 stretch fabric
- Full-length YKK® zipper with anti-jam system
- 2 zippered external side pockets
- 2 large inner pockets
- Stuff sack
- Elasticized waist
- Slim fit

A sophisticated vest that effectively combines the benefits of insulation with the performance of a softshell. The dual insulated body guarantees good thermal insulation while the elasticized fabric side panels and waist band deliver high levels of dexterity and breathability. The Hybrid Vest is perfect as an over layer with a performance fit that works well with a harness or as an insulating layer under a shell in more extreme conditions where the Slim fit reduces the overall profile of the entire layering system.

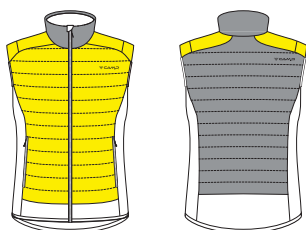

PrimaLoft® Black Rise 80 g/m²



80/20 WDD R.D.S.

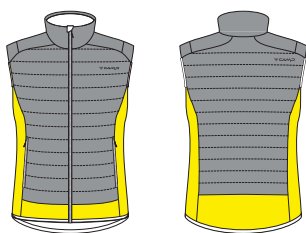

Hitex Evo



FlexTex 2.0

Ref.	Product name	Sizes	Weight			Exterior Fabrics	Filling: Down			Filling: PrimaLoft®		Hood	Cut
			Size	g	oz		Type	Filling Power (cuin)	Average weight (g)	Type	Weight (g/m ²)		
3314	HYBRID VEST	S-M-L XL-XXL	M	275	9.7	Hitex Evo / FlexTex 2.0	80/20 White Duck Down R.D.S.	600	25	PrimaLoft® Black Rise	80		Slim Fit



3 Kiwi Green / Lime Punch



1 Black / Asphalt Grey

2 Blue / Lime

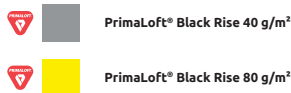
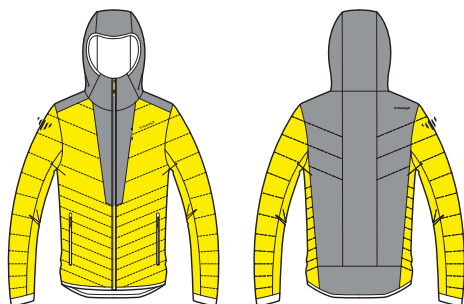

VERTEX JACKET

3406

LIGHT&FAST



ALPINISM, SKI MOUNTAINEERING, MOUNTAINEERING, LIFESTYLE

- Hyperlight and packable jacket with synthetic insulation for light and fast mountain athletes.
- Differentiated synthetic insulation
- PrimaLoft® Black Rise 80 g/m² on the front, sides and sleeves
- PrimaLoft® Black Rise 40 g/m² on the back, shoulders and hood
- Hitex Evo ripstop nylon shell is light, strong, and still highly weather resistant with a DWR treatment
- T-Lite inner lining
- Fixed technical hood with elasticized edging
- Full-length YKK® front zip with anti-jam system
- 2 external side zip pockets
- External chest pocket with vertical zip
- 2 large internal elasticized pockets
- Stuff sack
- Elasticated waist
- Cuffs in stretch fabric
- Slim Fit

The Vertex Jacket is a lightweight, packable jacket that embodies the Essential philosophy for light and fast mountain athletes. Every detail is designed for action. 100% synthetic insulation will continue to protect even when it is wet and compressed. The parts of the jacket that get the most exposure use PrimaLoft® Black Rise 80 g/m² and the back, shoulders and hood use PrimaLoft® Black Rise 40 g/m². The Hitex Evo nylon ripstop shell fabric is lightweight, durable, and packable and uses a DWR (durable water repellent) coating for a high level of protection from wind and moisture. Packed in its stuff sack, the Vertex Jacket is so light and compact you run out excuses not to carry it.

Ref.	Product name	Sizes	Weight			Exterior Fabrics	Filling: PrimaLoft®		Hood	Cut
			Size	g	oz		Type	Weight (g/m ²)		
3406	VERTEX JACKET	S-M-L XL-XXL	M	365	12.9	Hitex Evo	PrimaLoft® Black Rise	80 / hood, back: 40	Classic	Slim Fit



1 Black / Yellow



2 Blue / Yellow

ADRENALINE JACKET 3.0

3316

SKI COMP



COMPETITIVE SKI MOUNTAINEERING, SKI MOUNTAINEERING, ALPINISM

- Jacket with PrimaLoft® Black Rise 80 g/m² insulation
- Hitex Evo ripstop nylon shell is light, strong, and still highly weather resistant with a DWR treatment
- T-Lite fabric lining
- Backside is longer than the front to help keep snow out without restricting mobility
- Adjustable hidden hood with stretch inserts fits securely over a helmet
- Full-length YKK® zipper with anti-jam system
- 2 external side pockets with zippers
- Outer chest pocket with zipper
- Stow-Away Pocket
- Adjustable elasticized waist
- Elasticized windproof cuffs
- Slim Fit

The Adrenaline Jacket 3.0 is specifically designed for long, cold ski mountaineering competitions—especially extreme races like the legendary Italian Mezzalama Trophy (the White Marathon) where high altitude and serious mountain conditions require insulated layers for safety. PrimaLoft® Black Rise 80 g/m² continues to insulate even when it is wet or compressed. Hitex Evo ripstop nylon is waterproof and breathable making it the right choice for variable conditions. Thanks to its Slim Fit construction, the Adrenaline Jacket 3.0 can be used both as a mid-layer under the outer shell or as an external layer.



1 Black / Yellow

ADRENALINE PANT 3.0

3317

SKI COMP



COMPETITIVE SKI MOUNTAINEERING, SKI MOUNTAINEERING, ALPINISM

- Pants with PrimaLoft® Black Rise 40 g/m² insulation
- Front part made from Hitex Evo ripstop nylon fabric with PrimaLoft® insulation
- The back side is constructed from Hitex Evo fabric with PrimaLoft® insulation from the knees down and stretch fabric with no insulation above the knees
- T-Lite fabric lining
- Full-length YKK® zippers allow the pants to be put on over boots and skis
- Stow-Away Pocket
- Adjustable elasticized waist
- Shaped knees with reinforced lower legs for a performance fit
- Elastic straps with Velcro closures ensure a tight fit around boots
- Nivix Evo fabric reinforcements on the ankles for extra durability

The Adrenaline Pant 3.0 was designed in line with the Adrenaline Jacket 3.0 to deliver warmth, comfort and performance during long distance ski mountaineering competitions—especially extreme races like the legendary Italian Mezzalama Trophy (the White Marathon) where high altitude and serious mountain conditions require insulated layers for safety. Comfort is ensured by the PrimaLoft® Black Rise 40 g/m² insulation. Full-length zippers allow the pants to be put on and stripped off without removing boots or skis and elastic straps and a strong Velcro closure ensure a tight fit around boots.

Ref.	Product name	Sizes	Weight			Exterior Fabrics	Filling: PrimaLoft®		Hood	Cut
			Size	g	oz		Type	Weight (g/m ²)		
3316	ADRENALINE JACKET 3.0	XS-S-M L-XL	M	380	13.4	Hitex Evo	PrimaLoft® Black Rise	80	Foldable	Slim Fit
3317	ADRENALINE PANT 3.0	XS-S-M L-XL	M	350	12.4	Hitex Evo / Elastic Fabric	PrimaLoft® Black Rise	40		Slim Fit



5 Purple / Asphalt Grey



3 Blue / Magenta



1 Asphalt Grey / Asphalt Grey



4 Black / Sky blue

NIVIX LIGHT JACKET LADY

3307

LADY

SKI MOUNTAINEERING, ALPINE SKIING, ALPINISM, MOUNTAINEERING, LIFESTYLE

- Premium-grade white duck down with 750+ fill power
- Flowtex nylon ripstop fabric is extremely soft and pleasant to the touch, with a DWR treatment
- T-Lite fabric lining
- Full-size fixed hood with visor fits over a helmet
- Full-length YKK® zipper with anti-jam system
- 2 zippered external side pockets
- 2 large inner pockets
- Ski pass pocket on the left sleeve
- Stuff sack
- Adjustable waist with elastic cord
- Elasticized windproof cuffs
- Elasticized sides for comfort and mobility
- Slim Fit

The Nivix Light Jacket Lady features a cut and colors designed specifically for women. The Nivix Light Jacket is a lighter version of the popular Nivix 2.0. It combines soft and supple Flowtex nylon ripstop fabric on the exterior with premium-grade white duck down (750 cuin) insulation for a fit and feel that is naturally pleasant.



9 Stone Grey / Sky Blue



1 Black / Asphalt Grey



6 Magenta / Asphalt Grey



7 Night Blue / Magenta



8 Asphalt Grey / Magenta



10 Purple / Sky Blue

PROTECTION JACKET LADY

3310

LADY

BEST SELLER

ALPINISM, SKI MOUNTAINEERING, MOUNTAINEERING, LIFESTYLE

- Premium-grade white duck down with 750+ fill power
- Linear construction for great comfort
- Hitex Evo ripstop nylon shell is light, strong, and still highly weather resistant with a DWR treatment
- T-Lite fabric lining
- Full-size hood is fixed and fits over a helmet
- Full-length YKK® zipper with anti-jam system
- 2 zippered external side pockets
- 2 large inner pockets
- Stow-Away Pocket
- Adjustable waist with elastic cord
- Elasticized windproof cuffs
- Elasticized sides for comfort and mobility
- Slim Fit

Stay warm and dry even in the most miserable conditions. The Protection Jacket Lady, with construction designed for the greatest comfort, is the right choice for protection from the cold and snow. This 'double shield' of protection comes from the blend of premium-grade white duck down insulation and superlight, strong, durable and breathable Hitex Evo ripstop nylon shell fabric with a DWR treatment. The full-size hood, inner and outer pockets and a special Stow-Away Pocket round out the features on this sleek jacket.

Ref.	Product name	Sizes	Weight			Exterior Fabrics	Filling: Down			Hood	Cut
			Size	g	oz		Type	Filling Power (cuin)	Average weight (g)		
3307	NIVIX LIGHT JACKET LADY	XS-S-M L-XL	S	390	13.8	Flowtex	90/10 White Duck Down R.D.S.	750	130	Classic	Slim Fit
3310	PROTECTION JACKET LADY	XS-S-M L-XL	S	355	12.5	Hitex Evo	90/10 White Duck Down R.D.S.	750	130	Technical	Slim Fit

HYBRID JACKET LADY

3315



LADY

ALPINISM, SKI MOUNTAINEERING, LIFESTYLE



5 Water Blue / Black / Sky Blue



1 Black / Black / Magenta

6 Purple / Black / Asphalt Grey

7 Stone Grey / Black / Magenta

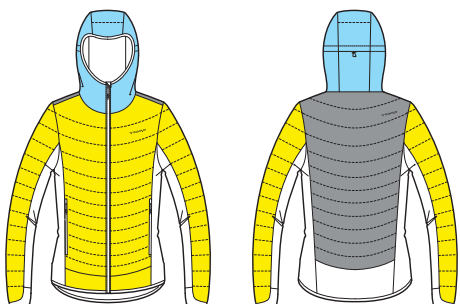

PrimaLoft® Black Rise 80 g/m²

PrimaLoft® Black Rise 40 g/m²BI

80/20 WDD R.D.S.

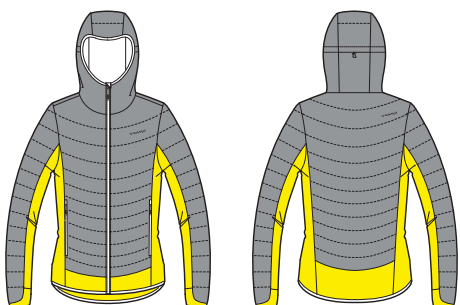

Hitex Evo

FlexTex 2.0

- Dual construction combines the benefits of insulation with a softshell
- Dual insulation with duck down and PrimaLoft® for optimal thermal protection
- The body, hood and sleeves use Hitex Evo ripstop nylon shell that is light, strong, and still highly weather resistant with a DWR treatment
- The sides, inner parts, sleeve panels and waist band use windproof FlexTex 2.0 stretch fabric
- Body front part and sleeves with 600+ fill power duck down insulation
- Body back part with PrimaLoft® Black Rise 80 g/m² that insulates even when wet
- Fixed hood with elasticized edging and PrimaLoft® Black Rise 40 g/m² padding
- Full-length YKK® zipper with anti-jam system
- 2 zippered external side pockets
- 2 large inner pockets
- Stuff sack
- Elasticized waist
- Elasticized windproof cuffs
- Slim Fit

The Hybrid Jacket Lady features a cut and colors designed specifically for women. The Hybrid Jacket, characterized by differentiated construction and insulation, effectively combines the advantages of an insulated jacket and a softshell. The insulated parts ensure good thermal insulation while the parts in stretch fabric ensure freedom of movement and breathability. Thermal performance is increased by the differentiated insulation on the torso and the FlexTex 2.0 fabric. Light and compact, the Hybrid Jacket is a versatile jacket designed for action. It can be used as stand-alone layer with the insulated hood or as a mid layer thanks to the Slim Fit.

ESSENTIAL LINE

Ref.	Product name	Sizes	Weight			Exterior Fabrics	Filling: Down			Filling: PrimaLoft®		Hood	Cut
			Size	g	oz		Type	Filling Power (cuin)	Average weight (g)	Type	Weight (g/m ²)		
3315	HYBRID JACKET LADY	XS-S-M L-XL	S	350	12.4	Hitex Evo / FlexTex 2.0	80/20 White Duck Down R.D.S.	600	50	PrimaLoft® Black Rise	80 / hood: 40	Classic	Slim Fit



4 Blue / Magenta



1 Black / Sky Blue



5 Water Blue / Lime Punch

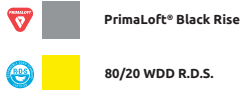

BURAN JACKET LADY

3318

LADY



ALPINISM, SKI MOUNTAINEERING, MOUNTAINEERING, LIFESTYLE

- A technical and versatile jacket for women designed to be worn while on the move
- Differentiated insulation with down and PrimaLoft® to guarantee the best thermal performance
- Hitex Evo ripstop nylon shell is light, strong, and still highly weather resistant with a DWR treatment
- T-Lite inner lining
- Fixed technical hood with elasticized edging
- Full-length YKK® front zip with anti-jam system
- 2 external zippered side pockets
- 2 large inner pockets and cell phone pocket
- Stow-Away Pocket
- Adjustable waist with elastic cord
- Elasticized windproof cuffs
- Regular Fit

The Buran Jacket Lady is our most technical jacket for women who want to push it in the mountains. It is designed to wear while on the move with differentiated insulation distributed for optimal thermal regulation. The front is duck down so it has better loft for the best insulation while everything else uses PrimaLoft® Black Rise 80 g/m² that can still insulate even when it is wet.

Ref.	Product name	Sizes	Weight			Exterior Fabrics	Filling: Down			Filling: PrimaLoft®		Hood	Cut
			Size	g	oz		Type	Filling Power (cuin)	Average weight (g)	Type	Weight (g/m ²)		
3318	BURAN JACKET LADY	XS-S-M L-XL	S	315	11.1	Hitex Evo	80/20 White Duck Down R.D.S.	600	30	PrimaLoft® Black Rise	80	Technical	Regular Fit

ESSENTIAL LINE

Essential sleeping bags



ED PLUS LINE
2701 - ED 400 PLUS
2702 - ED 200 PLUS



ED LINE
2729 - ED 500
2730 - ED 300
2731 - ED 150

Essential equipment



MINIMA 1 EVO
3231



MINIMA 2 EVO
3232



MINIMA 3 EVO
3233



MINIMA 1 SL
2392



MINIMA 2 SL
2393



MINIMA 3 SL
2394



ESSENTIAL LIGHT MAT
2181



PHANTOM 3.0
2632



GHOST
2628

ED 400 Plus
S Green Blue / Lime



ED 400 Plus
D Cobalt Blue / Grey



ED PLUS LINE

1ST CLASS

ALPINISM, TREKKING

- Superlight and quickly packable
- Features bigger dimensions than the ED Line for extra comfort
- Araneum fabric on the exterior and polyester on the interior combine with high-quality down for super insulation
- Available in 2 different fill weights (400, 200)
- Features a superb combination of warmth, weight and packability

The ED Plus line features the same top-quality construction and materials as the hyperlight ED line, but with bigger dimensions for extra comfort. The Araneum fabric shell interacts with premium grade white goose down for warm, dry insulation. These bags are true energy savers for fast packers who really need maximum performance and comfort with minimal weight and size.

Ref.	Product name	Weight		Length		Shoulder width		Foot width		Stuff Sack Size		Temperature		
		g	oz	cm	in	cm	in	cm	in	cm	in	Comfort (C°)	Limit (C°)	Extreme (C°)
2701	ED 400 PLUS	850	30.0	215	84.7	80	31.5	57	24.4	18x32	7.1x12.6	5	0	-15
2702	ED 200 PLUS	650	22.9	215	84.7	80	31.5	57	24.4	15x28	5.9x11.0	12	8	-4

Ref.	Product name	Filling			Construction	Fabrics		EN 13537
		Type	Weight	Filling Power (cuin)		Exterior	Interior	
2701	ED 400 PLUS	Down	400 g 90/10 GGD R.D.S.	650	Baffle Construction (B.C.)	Araneum 20D	320T Polyester	In Accordance
2702	ED 200 PLUS	Down	200 g 90/10 GGD R.D.S.	650	Stitched through (S.T.)	Araneum 20D	320T Polyester	In Accordance

TECHNICAL INFORMATION ED PLUS LINE / ED LINE

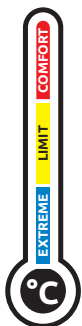

A graphic has been developed to display three relevant temperature ratings for every sleeping bag:

- COMFORT temperature is based on a standard woman having a comfortable night's sleep (neither cold nor warm).
- LIMIT temperature is the lowest temperature for a standard man to have a comfortable night's sleep.
- EXTREME temperature is the lowest temperature before health risk can occur.

Consumers will find one of this two different markings on all C.A.M.P. sleeping bags:

- Temperature tested to EN 13537: identifies all the sleeping bags that have been tested by a specialized and authorized centre (Kansas State University, Usa).
- Temperature rating in accordance with EN 13537: indicates that the marked temperature on a sleeping bag has been calculated by C.A.M.P.

FILLING POWER

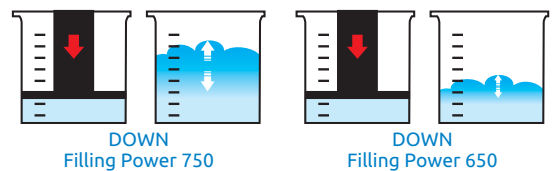

Filling power is the "filling ability" of down. The filling power value is obtained by measuring the volume of space which can be occupied by one ounce (28 g) of down under a predetermined load, and is expressed in cubic inches. The best down reaches the highest volume. The higher the filling power, the better the warmth retention is.

D Strawberry Red

S Black



ED LINE

LIGHT&FAST BEST SELLER

ALPINISM, TREKKING

- A fantastic lightweight and packable sleeping bag line
- Araneum fabric on the exterior and polyester on the interior combine with high-quality down for excellent insulation
- Available in 3 different fill weights (500, 300, 150)
- Baffled construction for the 500 and 300 models, stitched-through construction for the 150 model
- Features a superb combination of warmth, weight, and packability

The ED line combines our best fabrics with our highest-quality down insulation and top-level construction for the very best combination of warmth, weight, and packability. The Araneum fabric shell interacts with premium grade white goose down for warm, dry insulation. The tight-fitting cut further reduces the packed size and maximizes heat retention. For the lightest, fastest adventures, the ED line is the way to go.



Ref.	Product name	Weight		Length		Shoulder width		Foot width		Stuff Sack Size		Temperature		
		g	oz	cm	in	cm	in	cm	in	cm	in	Comfort (C°)	Limit (C°)	Extreme (C°)
2729	ED 500	870	30.7	205	80.7	75	29.5	55	21.7	17x34	6.7x13.4	4	-1	-17
2730	ED 300	670	23.7	205	80.7	75	29.5	55	21.7	14x33	5.5x13.0	9	4	-10
2731	ED 150	500	17.6	205	80.7	75	29.5	55	21.7	13x28	5.1x11.0	13	10	-3

Ref.	Product name	Filling			Construction	Fabrics		EN 13537
		Type	Weight	Filling Power (cuin)		Exterior	Interior	
2729	ED 500	Down	500 g 90/10 GGD R.D.S.	650	Baffle Construction (B.C.)	Araneum 20D	320T Polyester	In Accordance
2730	ED 300	Down	300 g 90/10 GGD R.D.S.	650	Baffle Construction (B.C.)	Araneum 20D	320T Polyester	In Accordance
2731	ED 150	Down	150 g 90/10 GGD R.D.S.	650	Stitched through (S.T.)	Araneum 20D	320T Polyester	In Accordance

MAIN FEATURES ED PLUS LINE / ED LINE



Goose down: 100% natural filling in order to reach the best weight to volume ratio.



Araneum (20D - 100% Nylon - Ripstop - 35 g/m²): Down proof by construction, cire on backside, W/R finish. Due to the very fine 20D thread (9000 meters weighing just 20 grams) this fabric is lightweight and more packable (at least 50%) than traditional fabrics. High strength fabric with exceptional breathability. The Ripstop version offers improved tear resistance.

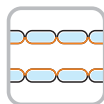

Stitched through (S.T.): construction with shell and lining stitched together.

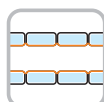

Baffle Construction (B.C.): baffle walls connecting shell and lining and creating horizontal down channels, which avoids cold spots.



Hood collar: insulated face gasket around the hood-opening to seal in warmth. It can be adjusted by an elastic cord.



Pre-shaped hood: for perfect insulation around the head; constructed to grant protection and comfort; with one-hand draw cord system for easy adjustment, reduces heat dispersion to a minimum.

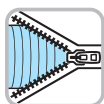

Zipper-Draft-Tube: protection against cold spots on inner side all along the zipper.

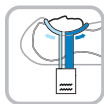

Form-coded draw cord: a round elastic cord combined with one flat lace help you identify which one you want to pull in order to adjust the hood even in the darkest night. The elastic cord controls the upper part of the hood, while the lace is used to adjust the lower part.

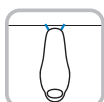

Hanging loops: loops for hanging the sleeping bags, useful to give it an airing.

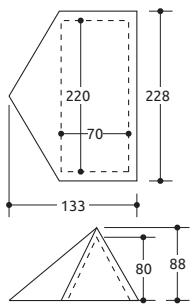

Video



MINIMA 1 EVO

3231

ALPINISM, TREKKING

- Double wall, compact and super lightweight single-person tent
- Free standing structure with integrated pole system and fast-clip attachments for quick and easy set up
- Single entry with large vestibule
- Full netting for maximum ventilation
- 2 internal storage pockets
- Lightweight, strong, waterproof rainfly is constructed with taped seams
- Foldable ground flaps provide extra protection from intense rain and wind
- 2 large openings for cross ventilation
- Rainfly attaches to the poles with Velcro® straps
- Adjustable guy lines for safe and easy tensioning
- The ground sheet is fixed with an adjustment system for easy positioning of the corners without moving the tent
- 15 cm aluminum alloy stakes are strong and lightweight
- Compression carrying bag, stakes and guy line tensioners included

The Minima 1 Evo is a hyperlight double wall tent that is free standing with an integrated pole system and fast-clip attachments for quick and easy set up. The full mesh netting main structure is extremely breathable. The rainfly is lightweight, strong and waterproof with taped seam construction. Foldable ground flaps on the rainfly provide extra protection from intense rain or they can be folded in to provide extra protection from wind. The single large zip entry is protected by a large vestibule. Stability is increased with floor tensioning lines that allow the corners to be positioned for optimal placement of the stakes without moving the tent. The stakes are 15 cm, constructed from aluminum alloy with a V shape for the right balance of strength and lightweight.

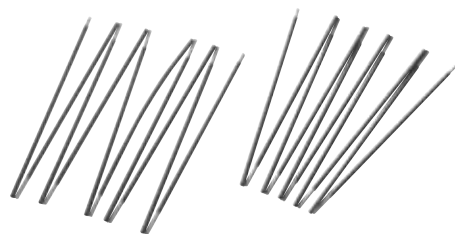

MINIMA 1 EVO TENT POLES

3234

Ref.	Product name	Weight		Packed size		External dimensions		Internal dimensions		Sleeps	Materials		Water Column		Entrances	Poles material
		g	oz	cm	in	cm	in	cm	in		N°	Fly Sheet	Floor	Fly sheet (mm)		
3231	MINIMA 1 EVO	1520	53.7	40x14	15.7x5.5	228x133xh 88	89.8x52.4xh 34.6	220x70xh 80	86.6x27.6xh 31.5	1	Nylon Ripstop 30D	70D Nylon 190T/N	2000	5000	1	Alu 7001

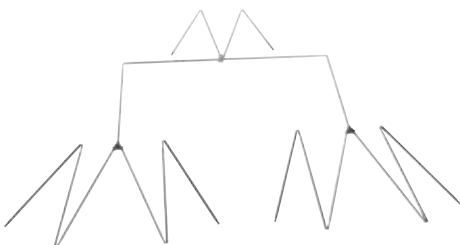
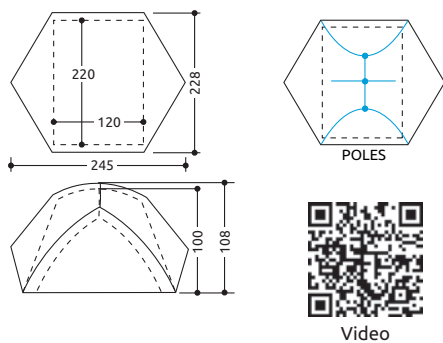

MINIMA 2 EVO

3232

1ST CLASS

ALPINISM, TREKKING

- Double wall, compact and super lightweight two-person tent
- Free standing structure with integrated pole system and fast-clip attachments for quick and easy set up
- Two entrances with large vestibules
- Full netting for maximum ventilation
- 2 internal storage pockets
- Lightweight, strong, waterproof rainfly is constructed with taped seams
- Foldable ground flaps provide extra protection from intense rain
- 2 large openings for cross ventilation
- Rainfly attaches to the poles with Velcro® straps
- Adjustable guy lines for safe and easy tensioning
- The ground sheet is fixed with an adjustment system for easy positioning of the corners without moving the tent
- 15 cm aluminum alloy stakes are strong and lightweight
- Compression carrying bag, stakes and guy line tensioners included

The Minima 2 Evo is a hyperlight double wall two-person tent that is free standing with an integrated pole system and fast-clip attachments for quick and easy set up. The full mesh netting main structure is extremely breathable. The rainfly is lightweight, strong and waterproof with taped seam construction. Foldable ground flaps on the rainfly provide extra protection from intense rain or they can be folded in to provide extra protection from wind. Two large zip entries are protected by large vestibules. Stability is increased with floor tensioning lines that allow the corners to be positioned for optimal placement of the stakes without moving the tent. The stakes are 15 cm, constructed from aluminum alloy with a V shape for the right balance of strength and lightweight.

MINIMA 2 PRO / MINIMA 2 EVO TENT POLES

2963

Ref.	Product name	Weight		Packed size		External dimensions		Internal dimensions		Sleeps	Materials		Water Column		Entrances	Poles material
		g	oz	cm	in	cm	in	cm	in		N°	Fly Sheet	Floor	Fly sheet (mm)		
3232	MINIMA 2 EVO	2260	79.8	50x18	19.7x7.1	228x245x108	89.8x96.5x42.5	220x120x100	86.6x47.2x39.4	2	Nylon Ripstop 30D	70D Nylon 190T/N	2000	5000	2	Alu 7001

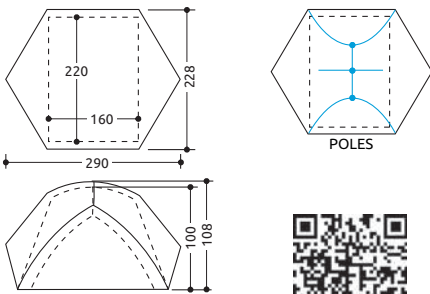

Video

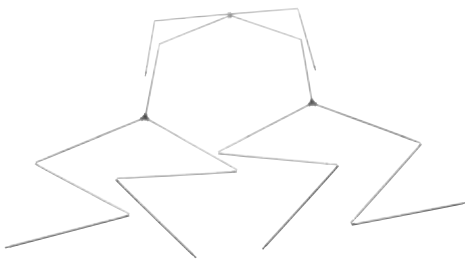

MINIMA 3 EVO

3233

ALPINISM, TREKKING

- Double wall, compact and super lightweight three-person tent
- Free standing structure with integrated pole system and fast-clip attachments for quick and easy set up
- Two entrances with large vestibules
- Full netting for maximum ventilation
- 2 internal storage pockets
- Lightweight, strong, waterproof rainfly is constructed with taped seams
- Foldable ground flaps provide extra protection from intense rain
- 2 large openings for cross ventilation
- Rainfly attaches to the poles with Velcro® straps
- Adjustable guy lines for safe and easy tensioning
- The ground sheet is fixed with an adjustment system for easy positioning of the corners without moving the tent
- 15 cm aluminum alloy stakes are strong and lightweight
- Compression carrying bag, stakes and guy line tensioners included

The Minima 3 Evo is a hyperlight double wall three-person tent that is free standing with an integrated pole system and fast-clip attachments for quick and easy set up. The full mesh netting main structure is extremely breathable. The rainfly is lightweight, strong and waterproof with taped seam construction. Foldable ground flaps on the rainfly provide extra protection from intense rain or they can be folded in to provide extra protection from wind. Two large zip entries are protected by large vestibules. Stability is increased with floor tensioning lines that allow the corners to be positioned for optimal placement of the stakes without moving the tent. The stakes are 15 cm, constructed from aluminum alloy with a V shape for the right balance of strength and lightweight.

MINIMA 3 PRO / MINIMA 3 EVO TENT POLES

2964

Ref.	Product name	Weight		Packed size		External dimensions		Internal dimensions		Sleeps	Materials		Water Column		Entrances	Poles material
		g	oz	cm	in	cm	in	cm	in		N°	Fly Sheet	Floor	Fly sheet (mm)		
3233	MINIMA 3 EVO	2530	89.3	50x18	19.7x7.1	228x290x108	89.8x114.2x42.5	220x160x100	86.6x63x39.4	3	Nylon Ripstop 30D	70D Nylon 190T/N	2000	5000	2	Alu 7001

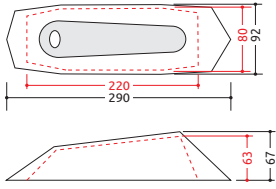

MINIMA 1 SL

2392

LIGHT&FAST

TREKKING

- Double wall, compact, superlight tent
- Just 1.1 kg (2.4 lbs) including poles and stakes!
- Single person fit
- Single opening
- Main structure is full netting for maximum ventilation
- Rain fly is light, strong and completely waterproof
- Assembles with poles and mesh channels
- Easy and fast disassembly
- Includes compression carrying bag and stakes

The Minima 1 SL is one of the lightest double wall single person tents on the market. By reducing the diameter of the poles and switching up materials on the fly, we are able to reduce weight to the absolute minimum. Double wall tents are the best for regulating variable conditions on long through hikes. The main structure is full netting to provide good ventilation. Add the fly and it becomes toasty enough even for light winter camping.

MINIMA 1 SL TENT POLES

0136



MINIMA 2 SL

2393

BEST SELLER

TREKKING

- Double wall, compact, superlight tent
- Just 1.5 kg (3.5 lbs) including poles and stakes!
- Fits two people
- Single opening
- Main structure is full netting for maximum ventilation
- Rain fly is light, strong and completely waterproof
- Assembles with poles and mesh channels
- Easy and fast disassembly
- Includes compression carrying bag and stakes

The Minima 2 SL has enough space for two people. By reducing the diameter of the poles and switching up materials on the fly, we are able to reduce weight to the absolute minimum. Double wall tents are the best for regulating variable conditions on long through hikes. The main structure is full netting to provide good ventilation. Add the fly and it becomes toasty enough even for light winter camping.

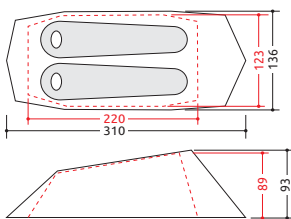

MINIMA 2 SL TENT POLES

0139



Ref.	Product name	Weight		Packed size		External dimensions		Internal dimensions		Sleeps	Materials		Water Column		Entrances	Poles material
		g	oz	cm	in	cm	in	cm	in		N°	Fly Sheet	Floor	Fly sheet (mm)		
2392	MINIMA 1 SL	1100	38.8	30x12	11.8x4.7	290x92xh 67	114.2x36.2xh 26.4	220x80xh 63	86.6x31.5xh 24.8	1	Nylon Ripstop 30D	70D Nylon 190T/N	2000	5000	1	Alu 7001
2393	MINIMA 2 SL	1500	52.9	33x16	13.0x6.3	310x136xh 93	122.0x53.5xh 36.6	220x125xh 89	86.6x49.2xh 35.0	2	Nylon Ripstop 30D	70D Nylon 190T/N	2000	5000	1	Alu 7001

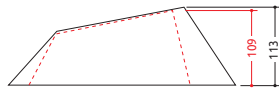
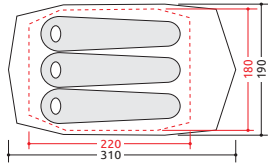

MINIMA 3 SL

2394

TREKKING

- Double wall, compact, superlight tent
- Just 2.1 kg (4.1 lbs) including poles and stakes!
- Fits three people
- Single opening
- Main structure is full netting for maximum ventilation
- Rain fly is light, strong and completely waterproof
- Assembles with poles and mesh channels
- Easy and fast disassembly
- Includes compression carrying bag and stakes

The Minima 3 SL completes the Minima SL range with a tent that has enough space for three people. It has the same features as the other SL models to guarantee a high level of performance with minimal weight and space in the pack. Double wall tents are the best for regulating variable conditions on long through hikes. The main structure is full netting to provide good ventilation. Add the fly and it becomes toasty enough even for light winter camping.

MINIMA 3 SL TENT POLES

0763



Ref.	Product name	Weight		Packed size		External dimensions		Internal dimensions		Sleeps N°	Materials		Water Column		Entrances N°	Poles material
		g	oz	cm	in	cm	in	cm	in		Fly Sheet	Floor	Fly sheet (mm)	Floor (mm)		
2394	MINIMA 3 SL	2100	74.1	37x17	14.6x6.7	310x190xh 113	122.0x74.8xh 44.5	220x180xh 109	86.6x70.9xh 42.9	3	Nylon Ripstop 30D	70D Nylon 190T/N	2000	5000	1	Alu 7002



ESSENTIAL LIGHT MAT

2181

TREKKING

- Packs down to less than 2% of its inflated size!

The Essential Light Mat is the light and compact mat for hikers who need to cut space and weight everywhere possible. Because there is no foam, it rolls down to less than 2% of its inflated size and the 100% polyamide exterior allows it to be both strong and hyperlight at the same time. Two valves (one plastic, one brass) speed up inflation and deflation.

NEW

Ref.	Product name	Weight		Packed size		Dimensions		Main material
		g	oz	cm	in	cm	in	
2181	ESSENTIAL LIGHT MAT	315	11.1	6x24	2.4x9.4	180x45x3	70.9x17.7x1.2	Polyamide + brass valve



3 Lime



1 Black



PHANTOM 3.0

2632

HIKING, MULTI-PITCH CLIMBING, LIFESTYLE

- Lightweight 15-liter pack for mountain excursions
- Packs into a small self-contained pouch that can be carried on the waist when not in use
- New lightweight fabric features a very high tensile strength
- Large main compartment + front zip compartment
- Large side mesh pockets for extra storage and easy access to essentials
- Back panel is constructed from 3D mesh for improved breathability and comfort
- Ergonomic shoulder straps are ventilated with soft mesh padding
- New higher profile waist belt with soft 3D mesh padding and zippered pockets
- Lightweight bungee straps for carrying trekking poles
- External bungee straps for load compression and carrying extra layers
- Available in 2 colors

The Phantom 3.0 is a hyperlight 15-liter pack with a large number of options for additional storage on the exterior. It features a large front zip pocket, two large side mesh pockets, accessory pockets on the waist belt, and a 15-liter main compartment all in a hyperlight package that stows away into a small self-contained pouch when not in use. New hyperlight fabric combines with soft 3D mesh on the shoulder straps and waist belt for the right combination of lightweight, strength, durability, comfort and packability. The waist belt has a new higher profile for additional support and comfort on long outings. External bungee straps can be used to compress loads and carry layers and a simple elastic cord system securely attaches a set of trekking poles.

Ref.	Product name	Volume	Weight		Packed size		Main material
			g	oz	cm	in	
2632	PHANTOM 3.0	15 L	430	15.2	13x20	5.1x7.9	Polyamide



3 Lime



2 Light Blue



1 Black



GHOST

2628

HIKING, LIFESTYLE

- Hyperlight 15-liter pack stows away into a self-contained pouch that can be carried on the waist when not in use
- New superlight fabric features a very high tensile strength
- Ergonomic shoulder straps constructed from lightweight fabric
- Lightweight bungee straps for carrying trekking poles
- External bungee straps for load compression and carrying extra layers
- Available in 3 colors

A hyperlight and compact pack for carrying the essentials on intense excursions like day hikes or peak bagging. External bungee straps can be used to compress loads and carry layers and a simple elastic cord system securely attaches a set of trekking poles. The new superlight fabric features a very high tensile strength and is coated for extra protection from moisture and abrasion. When not in use, the Ghost packs down into a self-contained pocket that can then be carried around the waist or in the lid of a larger pack.

Ref.	Product name	Volume	Weight		Packed size		Main material
			g	oz	cm	in	
2628	GHOST	15 L	165	5.8	5x14	2.0x5.5	Polyamide

WINTER GLOVES



Authentic wilderness in the Ortles-Cevedale group, descending into Val Martello from Punta del Lago Gelato (3230 m), Italy © Giacomo Meneghello

WINTER GLOVES

Fit = Function

C.A.M.P. gloves were originally designed for ski mountaineering, but the beautifully profiled fit combined with innovative, lightweight materials and high-quality construction has propelled them further. As skiers and alpinists push it in the mountains, we continue to work on advancing the line in any direction where the superior fit that C.A.M.P. gloves have become known for can lead to superior function.

A complete collection

Gloves are an essential piece of gear in every season in the mountains. We rely on our hands for a great many things and the more technical the activity, the more we have to pay attention to them. The range of C.A.M.P. gloves is a complete range for almost any kind of mountain activity from technical ice climbing and alpinism to high-altitude mountaineering to ski mountaineering and ski touring to general outdoor activities and day-to-day protection from the elements. Every activity demands its own unique set of features. Each model of C.A.M.P. gloves is designed with this in mind and is purpose-built for its intended use.

The Collection

Geko Line - Designed for alpinism and ice climbing, Geko gloves guarantee the right blend of warmth, dexterity, grip and durability.

G Line - A diverse line of insulated gloves for those who really live the mountains. The range has been expanded from its roots in ski mountaineering to now include models for other light and fast pursuits.

Air Line - Hyperlight, super compact insulated gloves for active mountain pursuits.

K Line - Characterized by innovative 3-D Knitting Technology construction for top-level ergonomics and unparalleled freedom of movement and sensitivity.

Mitt'n Line - Maximum protection when the temps become extreme.

Each model has a thermal insulation number from 0 to 5 (0 for 'No thermal insulation', 5 for 'Most thermal insulation'). This classification is useful for comparing the different models, but should not be considered in absolute terms. Other factors like humidity, wind, sweat, intensity of effort, conditions and physical characteristics of the person can greatly influence the feeling of heat to the hands.



CATEGORY LEADERS



1ST CLASS
GEKO ICE PRO
3150



1ST CLASS
AIR MITT EVO
3325



LIGHT&FAST
G COMP EVO
3395



BEST SELLER
G COMP WARM
2826



BEST SELLER
G AIR
2834

Geko Line

Ref.	Product name	Sizes	Weight/Pair													
			Size	g	oz											
3392	GEKO ALPINE	XS-S-M-L-XL-XXL-XXXL	M	190	6.7	4	•	•	•	•	•	•	•	•	•	•
3150	GEKO ICE PRO	S-M-L-XL-XXL-XXXL	M	150	5.3	2	•	•	•	•	•	•	•	•	•	•
3391	GEKO GUIDE	XS-S-M-L-XL-XXL-XXXL	M	160	5.6	3	•	•	•	•	•	•	•	•	•	•
3394	GEKO PULSE	S-M-L-XL-XXL-XXXL	M	115	4.1	2	•	•	•	•	•	•	•	•	•	•
3321	GEKO HOT EVO	S-M-L-XL-XXL-XXXL	M	140	4.9	3	•	•	•	•	•	•	•	•	•	•
3393	GEKO HOT	S-M-L-XL-XXL-XXXL	M	135	4.8	3	•	•	•	•	•	•	•	•	•	•

G Line

Ref.	Product name	Sizes	Weight/Pair													
			Size	g	oz											
3396	G COMP WARM	S-M-L-XL-XXL-XXXL	M	100	3.5	1 (without overmitt) 2 (with overmitt)	•	•	•	•	•	•	•	•	•	•
3397	G COMP WARM LADY	XS-S-M-L	S	90	3.2	1 (without overmitt) 2 (with overmitt)	•	•	•	•	•	•	•	•	•	•
3395	G COMP EVO	XS-S-M-L-XL-XXL	M	85	3.0	1	•	•	•	•	•	•	•	•	•	•
3154	G TECH EVO	XS-S-M-L-XL-XXL	M	125	4.4	2	•	•	•	•	•	•	•	•	•	•
3156	G PURE	XS-S-M-L-XL-XXL-XXXL	M	100	3.5	3	•	•	•	•	•	•	•	•	•	•
3324	G PURE WARM	XS-S-M-L-XL-XXL-XXXL	M	135	4.8	3 (without overmitt) 4 (with overmitt)	•	•	•	•	•	•	•	•	•	•
3322	G HOT WOOL	S-M-L-XL-XXL-XXXL	M	150	5.3	4	•	•	•	•	•	•	•	•	•	•
3323	G HOT WOOL LADY	XS-S-M-L	S	135	4.8	4	•	•	•	•	•	•	•	•	•	•
2830	G LITE WIND	XS-S-M-L-XL-XXL	M	85	3.0	1	•	•	•	•	•	•	•	•	•	•
3155	G WOOL	XS-S-M-L-XL-XXL	M	115	4.1	2	•	•	•	•	•	•	•	•	•	•

Air Line

Ref.	Product name	Sizes	Weight/Pair													
			Size	g	oz											
2834	G AIR	XS-S-M-L-XL-XXL-XXXL	M	60	2.1	2	•	•	•	•	•	•	•	•	•	•
3399	G AIR LADY	XS-S-M-L	S	55	1.9	2	•	•	•	•	•	•	•	•	•	•
3151	G AIR HOT DRY	XS-S-M-L-XL-XXL-XXXL	M	105	3.7	3	•	•	•	•	•	•	•	•	•	•
3398	G AIR CORE	XS-S-M-L-XL-XXL-XXXL	M	120	4.2	4	•	•	•	•	•	•	•	•	•	•
3400	G AIR B-MITT	S-M-L-XL	M	70	2.5	3	•	•	•	•	•	•	•	•	•	•

K Line

Ref.	Product name	Sizes	Weight/Pair													
			Size	g	oz											
2995	K WARM	XS-S-M-L-XL-XXL-XXXL	M	125	4.4	3	•	•	•	•	•	•	•	•	•	•
2996	K AIR	XS-S-M-L-XL-XXL-XXXL	M	75	2.6	2	•	•	•	•	•	•	•	•	•	•

Mitt'N Line

Ref.	Product name	Sizes	Weight/Pair													
			Size	g	oz											
3325	AIR MITT EVO	S-M-L-XL	M	105	3.7	3	•	•	•	•	•	•	•	•	•	•
2989	TEMPEST MITT EVO	S-M-L-XL	M	125	4.4	4	•	•	•	•	•	•	•	•	•	•
2836	SUMMITT N	S-M-L	M	175	6.2	5	•	•	•	•	•	•	•	•	•	•
2837	HOTMITT N	S-M-L	M	215	7.6	5	•	•	•	•	•	•	•	•	•	•

Thermal insulation

To specify the level of thermal insulation of each model, we use a scale that goes from 0 for 'No thermal insulation' to 5 for 'Most thermal insulation'.

The perceived warmth and the thermal insulation of the gloves can be influenced by several factors such as humidity, wind, physical conditions, etc.



THERMAL INSULATION



WINDBREAK



WATERPROOF



BREATHABLE



TOUCHSCREEN COMPATIBLE



WRIST LEASHES



GRIP'R



CUFF LOOPS FOR PULLING ON



CLIPPABLE HANGING LOOPS



SWEEP CLOTH



ETCHED LEATHER



PRIMALOFT

WINTER GLOVES

Geko Line



GEKO ALPINE
3392



GEKO ICE PRO
3150



GEKO GUIDE
3391



GEKO PULSE
3394



GEKO HOT EVO
3321



GEKO HOT
3393

G Line



G COMP WARM
3396



G COMP WARM LADY
3397



G COMP EVO
3395



G TECH EVO
3154



G PURE
3156



G PURE WARM
3324



G HOT WOOL
3322



G HOT WOOL LADY
3323



G LITE WIND
2830



G WOOL
3155

Air Line



G AIR
2834



G AIR LADY
3399



G AIR HOT DRY
3151



G AIR CORE
3398



G AIR B-MITT
3400



G AIR HAT
3152

K Line



K WARM
2995



K AIR
2996

Mitt'N Line



AIR MITT EVO
3325



TEMPEST MITT EVO
2989



SUMMITT'N
2836



HOTMITT'N
2837

Technology

Insulation



PrimaLoft® Gold

100% recycled polyester insulation.

Its ultra-soft microfibers offer excellent thermal efficiency with water repellency that retains 98% of the warmth even in wet conditions.

PrimaLoft® Gold Grip

100% recycled polyester insulation.

Its construction with anti-slip technology provides a secure and stable grip for high performance activities. Water-repellent and space-saving, it resists compression and offers freedom of movement and continues to retain warmth even in wet conditions.



Hyperloft

Extra warm insulation which, thanks to its very high and soft structure, isolates and keeps the heat inside the glove ensuring maximum comfort.

Finger construction



Box Finger: seamless construction on the fingertips for a performance fit that delivers exceptional sensitivity and grip on tools.

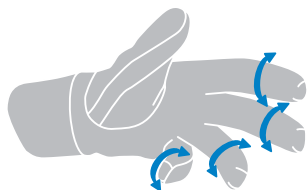

Dart Finger: simple construction that eliminates the side stitches of fourchettes in the fingers for excellent comfort.

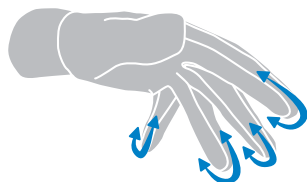

Roll finger: construction with fourchettes between the fingers to increase flexibility and provide a performance fit with maximum freedom of movement.

SIZE CHART



cm	Alphabetical sizes	Numerical sizes
12.5 - 14	XXS	5
14.5 - 16	XS	6
16.5 - 18	S	7
18.5 - 20.5	M	8
21 - 23	L	9
23.5 - 25.5	XL	10
26 - 28	XXL	11
28.5 - 30.5	XXXL	12

To determine your size, open your hand and measure the circumference of the palm in the widest part (excluding the thumb). Round to the nearest size.

Note. Measurements refer to hand size, not to product size. They can be used to help you determine your size, but the fit for each specific glove will vary based on its intended use. If possible, it is always best to try on gloves before purchasing.



GEKO ALPINE

3392

ALPINISM, ICE CLIMBING, MIXED CLIMBING



Black / Grey

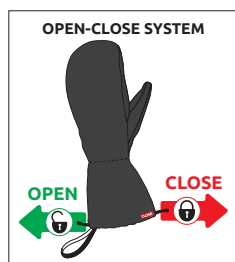

- Ice climbing gloves for maximum protection
- DRYZONE® waterproof/breathable membrane
- PrimaLoft® Gold 133 g/m² insulation on the main body and PrimaLoft® Gold Eco Grip Control 100 g/m² on the palm
- Palm and fingers in soft, resistant, water repellent and breathable goatskin
- Shaped fingers with 'Box Finger' construction, seamless on the fingertips for a great fit and exceptional grip and sensitivity
- Elongated wrists for tensioning over a jacket
- Velcro strap on the front of the wrist to help keep the glove in place
- Open-Close system is easy to operate while wearing gloves
- Clippable hanging loops
- Low profile buckles to join the gloves together

The Geko Alpine is designed to keep the hands protected and warm even in the nastiest conditions while still delivering a high level of precision and climbing performance. It has been purpose-built to deliver the right levels of protection, warmth, performance and durability for big routes in cold places. The elongated wrists are designed to be tensioned over the jacket to keep weather out and warmth in. The Open-Close system is easy to operate while wearing gloves and a Velcro strap at the wrist helps keep the glove in position on the hand. Warmth is guaranteed by the differentiated insulation with PrimaLoft® Gold 133 g/m² on the back and PrimaLoft® Gold Grip Control 100 g/m² on the palm. PrimaLoft® Gold Grip palm insulation combines with seamless 'Box Finger' construction for a high level of sensitivity and secure grip on tools. The DRYZONE® waterproof/breathable membrane creates a waterproof barrier and the goatskin palms are designed for intensive use.



Black



Video

GEKO ICE PRO

3150

1ST CLASS

ICE CLIMBING, MIXED CLIMBING, ALPINISM



- Palm with 'No Slip technology' to guarantee the best grip on tools
- DRYZONE® waterproof/breathable membrane
- PrimaLoft® Gold 60g/m² insulation on the main body
- Super strong Pittards Pearl Atomic Oiltac® goatskin on the palm and fingers to optimize grip
- Shaped fingers with 'Dart Finger' construction without fourchettes between the fingers for great dexterity and comfort
- Construction is very anatomical for increased precision and sensitivity
- Sweat pads on the thumbs
- Tight Velcro closure on the wrist
- Elastic wrist leashes
- Cuff loops for pulling on the gloves
- Clippable hanging loops
- Low profile buckles for clipping gloves together

The Geko Ice Pro is an innovative glove designed to deliver a solid grip on ice tools along with warm, dry protection from the elements. They are ideal for steep ice climbing, dry tooling and technical mixed terrain. Super strong Pittards Pearl Atomic Oiltac® goatskin leather on the palms and fingers features a special treatment to optimize grip in all kinds of conditions. The performance of the Geko Ice Pro is increased further with pre-shaped fingers and a new kind of construction that is very anatomical so it adheres tightly to the hand for maximum precision and sensitivity. The tight Velcro closure is on the top of the wrist and out of the way. PrimaLoft® Gold 60 g/m² insulation on the main body and the waterproof/breathable DRYZONE® membrane combine to deliver a high level of protection from the elements.

Ref.	Product name	Sizes	Weight/Pair										
			Size	g									
3392	GEKO ALPINE	XS-S-M-L-XL-XXL-XXXL	M	190	6.7	4	•	•	•	•	•	•	•
3150	GEKO ICE PRO	S-M-L-XL-XXL-XXXL	M	150	5.3	2	•	•	•	•	•	•	•



GEKO GUIDE

3391

ICE CLIMBING, MIXED CLIMBING, ALPINISM



Black / Orange



Video



- Technical climbing gloves for big mountain adventures
- DRYZONE® waterproof/breathable membrane
- PrimaLoft® Gold 100 g/m² insulation on the main body and PrimaLoft® Gold Eco Grip Control 60 g/m² on the palm
- Tough goatskin exterior for a high level of durability and protection
- Soft, supple goatskin on the palm and fingers with a special treatment to make it moisture repellant thereby keeping palm inside the glove dry
- Shaped fingers with 'Dart Finger' construction without fourchettes between the fingers for great dexterity and comfort
- 3 mm EVA knuckle protectors on all fingers
- Elongated wrist closure for extra protection
- Elastic wrist leashes
- Cuff loops for pulling on the gloves
- Clippable hanging loops
- Low profile buckles for clipping gloves together

The Geko Guide delivers a high level of climbing performance with a build intended for big mountain adventures. The tough goatskin body guarantees a high level of durability and protection. Knuckle protectors on all of the fingers provide protection on variable terrain and the shaped 'Dart Finger' construction delivers a high level of dexterity, comfort and the precise grip that Geko gloves are known for. Protection from the cold and from the elements is guaranteed with PrimaLoft® Gold 100 g/m² insulation on the main body, PrimaLoft® Gold Eco Grip Control 60 g/m² on the palm and the DRYZONE® waterproof/breathable membrane. Since mountaineers and alpinists first discovered Geko gloves, they have been asking for a robust version for their big mountain adventures. We are happy to present the purpose-built Geko Guide.



GEKO PULSE

3394

MIXED CLIMBING, ICE CLIMBING, ALPINISM



Black / Grey



- Sensitivity, precision and grip at the highest level
- Palm with 'No Slip technology' to guarantee the best grip on tools
- DRYZONE® waterproof/breathable membrane
- PrimaLoft® Gold 60g/m² insulation on the main body
- Reinforced Pro Grip goatskin palm for exceptional grip and durability
- Slightly shaped fingers with 'Roll Finger' construction combines with fourchettes between the fingers for great dexterity and fit
- Elastic wrists for a precise fit with inserts for pulling on the gloves
- Elastic wrist leashes
- Clippable hanging loops
- Low profile buckles for clipping gloves together

The Geko Pulse sets a new standard for sensitivity and precision with No Slip technology on the palm whereby all of the layers are coupled together to prevent any sliding. Combined with the Pro Grip goatskin leather palm, 'Roll Finger' construction and elastic wrists, the Geko Pulse is particularly form fitting and delivers exceptional levels of grip, sensitivity and dexterity. PrimaLoft® Gold 60 g/m² insulation on the back and the DRYZONE® waterproof/breathable membrane combine for a good level of protection from the elements.

Ref.	Product name	Sizes	Weight/Pair												
			Size	g	oz										
3391	GEKO GUIDE	XS-S-M-L-XL-XXL-XXXL	M	160	5.6	3	•	•	•	•	•	•	•	•	•
3394	GEKO PULSE	S-M-L-XL-XXL-XXXL	M	115	4.1	2	•	•	•	•	•	•	•	•	•



Black / Grey

GEKO HOT EVO

3321



ALPINISM, ICE CLIMBING, MIXED CLIMBING

- Modern mountaineering and climbing gloves designed to deliver the best combination of warmth and sensitivity
- Palm with 'No Slip technology' to guarantee the best grip on tools
- DRYZONE® waterproof/breathable membrane
- PrimaLoft® Gold 100 g/m² insulation on the main body and PrimaLoft® Gold Eco Grip Control 100 g/m² insulation on the palm
- Silicone Grip'R pads on the palm and fingers for exceptional grip
- Shaped fingers for exceptional dexterity, comfort and grip
- 3 mm EVA knuckle protection on the fingers
- Elastic wrist leashes
- Cuff loops for pulling on the gloves
- Clippable hanging loops
- Low profile buckles for clipping gloves together

The Geko Hot Evo is a modern mountaineering and climbing glove with a particularly soft, flexible and sensitive fit that still maintains all-mountain functionality with PrimaLoft® Gold insulation and the DRYZONE® waterproof/breathable membrane. Silicone Grip'R pads on the palm and fingers combine with shaped construction for exceptional grip. PrimaLoft® Gold 100 g/m² insulation on the back with PrimaLoft® Gold Eco Grip Control 100 g/m² insulation on the palm ensures good temperature regulation and warmth and 3mm EVA inserts on the fingers protect the knuckles while climbing.



Black

GEKO HOT

3393



ICE CLIMBING, ALPINISM, MIXED CLIMBING

- Supple, warm, comfortable, form-fitting technical ice climbing gloves
- PrimaLoft® Gold 100 g/m² insulation on the main body and PrimaLoft® Gold Eco Grip Control 100 g/m² on the palm
- Soft, supple goatskin on the palm with no stitches in the fingers for the best comfort, grip and sensitivity
- Shaped fingers with 'Box Finger' construction, seamless on the fingertips for a great fit and exceptional grip and sensitivity
- 3 mm EVA knuckle protectors on all fingers
- Elastic wrist leashes
- Cuff loops for pulling on the gloves
- Clippable hanging loops
- Low profile buckles for clipping gloves together

At its origin, the range of Geko glove are designed to deliver the best combination of protection and performance for every kind of ice climbing. The Geko Hot in particular strikes the best balance between warmth and sensitivity. No liner makes it particularly breathable and allows the layers to be fixed securely for a very precise grip. PrimaLoft® Gold 100 g/m² insulation on the main body and PrimaLoft® Gold Eco Grip Control 100 g/m² on the palm combines with seamless 'Box Finger' construction for a high level of sensitivity and a very secure grip on tools. 3 mm EVA knuckle protectors on the fingers provide extra protection on variable terrain.

Ref.	Product name	Sizes	Weight/Pair												
			Size	g	oz										
3321	GEKO HOT EVO	S-M-L-XL-XXL-XXXL	M	140	4.9	3	•	•	•	•	•	•	•	•	•
3393	GEKO HOT	S-M-L-XL-XXL-XXXL	M	135	4.8	3	•	•	•	•	•	•	•	•	•



Black / Green

G COMP WARM

3396

BEST SELLER SKI COMP



SKI MOUNTAINEERING, COMPETITIVE SKI MOUNTAINEERING

- Soft, dexterous, breathable gloves designed for ski mountaineering and cold-weather aerobic activities
- The special PrimaLoft® Gold 60 g/m² insulated Warmit'N hides in a pocket on the wrist ready to be pulled out for extra protection from the wind and cold with an elastic insert for a tight closure of the mitt over the glove
- Palms are reinforced for extra strength and durability with poles
- Silicone Grip'R pads on the palm for extra grip
- Fingers with 'Box Finger' construction, seamless on the fingertips for a great fit and exceptional grip and sensitivity
- Sweat pads on the thumbs
- Thumb and index finger are touch screen compatible
- Elastic wrists with cuff loops for pulling on the gloves
- Elastic wrist leashes
- Clippable hanging loops
- Low profile buckles for clipping gloves together

The G Comp Warm delivers a high level of protection from the cold with the special Warmit'N – a lightweight insulated overmitt with a ripstop nylon shell and PrimaLoft® Gold 60 g/m² insulation that stows away in a sleeve on the wrist when not in use and can be pulled out and over the fingers when they need extra protection (the palm remains exposed for grip and dexterity). The addition of the Warmit'N gives a level of versatility that other gloves simply cannot achieve. The base glove is designed to provide the right level of protection without overheating during aerobic use. Silicone Grip'R pads on the palm assist with grip, dexterity and fine motor control and the palms are reinforced for extra strength and durability with poles.

NOTE. Help ensure the longevity of the Warmit'N by always removing it when working with bindings and skins.



Black / Light Blue / Fuchsia

G COMP WARM LADY

3397

BEST SELLER SKI COMP LADY



SKI MOUNTAINEERING, COMPETITIVE SKI MOUNTAINEERING

- Soft, dexterous, breathable gloves designed for ski mountaineering and cold-weather aerobic activities
- The special PrimaLoft® Gold 60 g/m² insulated Warmit'N hides in a pocket on the wrist ready to be pulled out for extra protection from the wind and cold with an elastic insert for a tight closure of the mitt over the glove
- Palms are reinforced for extra strength and durability with poles
- Silicone Grip'R pads on the palm for extra grip
- Fingers with 'Box Finger' construction, seamless on the fingertips for a great fit and exceptional grip and sensitivity
- Sweat pads on the thumbs
- Thumb and index finger are touch screen compatible
- Elastic wrists with cuff loops for pulling on the gloves
- Elastic wrist leashes
- Clippable hanging loops
- Low profile buckles for clipping gloves together

The G Comp Warm designed specifically for female hands. The G Comp Warm Lady delivers a high level of protection from the cold with the special Warmit'N – a lightweight insulated overmitt with a ripstop nylon shell and PrimaLoft® Gold 60 g/m² insulation that stows away in a sleeve on the wrist when not in use and can be pulled out and over the fingers when they need extra protection (the palm remains exposed for grip and dexterity). The addition of the Warmit'N gives a level of versatility that other gloves simply cannot achieve. The base glove is designed to provide the right level of protection without overheating during aerobic use. Silicone Grip'R pads on the palm assist with grip, dexterity and fine motor control and the palms are reinforced for extra strength and durability with poles. NOTE. Help ensure the longevity of the Warmit'N by always removing it when working with bindings and skins.

Ref.	Product name	Sizes	Weight/Pair		Thermometer	Wind	Water	Breathability	Touch screen	Pole grip	Wrist leash	Clippable loops	Palm reinforcement	PrimaLoft
			Size	g										
3396	G COMP WARM	S-M-L-XL-XXL-XXXL	M	100	3.5	1 (without overmitt) 2 (with overmitt)	•	•	•	•	•	•	•	•
3397	G COMP WARM LADY	XS-S-M-L	S	90	3.2	1 (without overmitt) 2 (with overmitt)	•	•	•	•	•	•	•	•



Black / Red / Light Blue



G COMP EVO

3395

LIGHT&FAST SKI COMP



COMPETITIVE SKI MOUNTAINEERING, SKI MOUNTAINEERING

- Soft, light and breathable gloves for ski mountaineering and other cold-weather aerobic activities
- Windmit'N hides in a pocket on the wrist to be pulled out for protection from the wind and cold, with an elastic insert for a tight closure of the mitt over the glove
- Palms are reinforced for extra strength and durability with poles
- Silicone Grip'R pads on the palm for extra grip
- 'Roll Finger' construction combines with fourchettes between the fingers for great dexterity and fit
- Sweat pads on the thumbs
- Thumb and index finger are touch screen compatible
- Elastic wrists for a precise fit with inserts for pulling on the gloves
- Elastic wrist leashes
- Clippable hanging loops
- Low profile buckles for clipping gloves together

The G Comp Evo is an ideal glove for ski mountaineering races, spring ski tours and cold-weather aerobic activities. The glove is constructed from soft, dexterous, breathable fabric for great comfort and temperature regulation when on the move. When the fingers need more protection, simply pull out the hidden Windmit'N to cover the fingers and thumb while leaving the palm exposed for good grip. The palm is perforated for maximum breathability and features silicone Grip'R pads for extra grip and dexterity. They are also reinforced for extra strength and durability with poles.

NOTE. Help ensure the longevity of the Windmit'N by always removing it when working with bindings and skins.



Black / Light Blue



Video

G TECH EVO

3154

SKI MOUNTAINEERING, ALPINISM, MOUNTAINEERING

- Lightweight ski mountaineering gloves with layered construction instead of padded insulation for exceptional sensitivity and comfort
- Palm with 'No Slip technology' to guarantee the best grip on tools
- DRYZONE® waterproof/breathable membrane
- Soft, supple reinforced goatskin on the palm and fingers
- Shaped fingers with 'Box Finger' construction, seamless on the fingertips for a great fit and exceptional grip and sensitivity
- Sweat pads on the thumbs
- Thumb and index finger are touch screen compatible
- Elastic wrist leashes
- Cuff loops for pulling on the gloves
- Clippable hanging loops
- Low profile buckles for clipping gloves together

The G Tech Evo is a lightweight glove that does not use padded insulation. It protects the hands from the elements with layered construction and the DRYZONE® waterproof/breathable membrane. It is the right choice for ski mountaineering athletes looking for exceptional grip and a high level of sensitivity. Comfort and performance are further enhanced with new seamless construction on the fingertips.

Ref.	Product name	Sizes	Weight/Pair			🌡️	🌀	💧	🔄	👉	👉	👉	👉	👉	👉	👉	⚙️	🛑	
			Size	g	oz														
3395	G COMP EVO	XS-S-M-L-XL-XXL	M	85	3.0	1	•		•	•	•	•	•	•	•	•	•	•	•
3154	G TECH EVO	XS-S-M-L-XL-XXL	M	125	4.4	2	•	•		•	•	•	•	•	•	•	•	•	•



Black



Video

G PURE

3156

SKI MOUNTAINEERING, ALPINISM, MOUNTAINEERING

- A technical glove with distilled construction and all the features for technical mountain activities
- Palm with 'No Slip technology' to guarantee the best grip on tools
- DRYZONE® waterproof/breathable membrane
- Hyperloft 100 g/m² insulation on the main body
- Sheepskin palm with goatskin wear point reinforcements
- Fingers with 'Roll Finger' construction combines with fourchettes between the fingers for great dexterity and fit
- Thumb and index finger are touch screen compatible
- Elastic wrist leashes
- Low profile buckles for clipping gloves together

The construction of the G Pure has been distilled down to create a form-fitting glove that is ideal for technical mountain activities. The back has no seams and the wrist is elastic for all-day comfort. Protection from the cold and from the elements is guaranteed with Hyperloft 100 g/m² insulation on the main body and the DRYZONE® waterproof/breathable membrane. The sheepskin palm with goatskin reinforcements on the wear points delivers good grip and excellent durability.



G PURE WARM

3324

SKI MOUNTAINEERING, ALPINISM, MOUNTAINEERING



Black



Video

- Technical glove designed for maximum versatility in the mountains
- Integrated Primaloft® Gold60 g/m² insulated Warmit'N hides in a pocket on the wrist ready to be pulled out for extra protection from the wind and cold
- Palm with 'No Slip technology' to guarantee the best grip on tools
- Breathable base glove with Hyperloft 100 g/m² insulation on the main body
- Synthetic palm with Grip Control layer for excellent grip on poles and tools
- Fingers with 'Roll Finger' construction combines with fourchettes between the fingers for great dexterity and fit
- Thumb and index finger are touch screen compatible
- Elastic wrist leashes
- Cuff loops for pulling on the gloves
- Low profile buckles for clipping gloves together

The G Pure Warm is a technical glove designed for maximum versatility in the mountains with the integrated Primaloft® Gold60 g/m² insulated ripstop nylon Warmit'N that stows away in a sleeve on the wrist when not in use and can be pulled out and over the fingers when they need extra protection (the palm remains exposed for grip and dexterity). The construction for the base glove has been distilled down to create a form-fitting glove with no waterproof membrane for exceptional breathability. Hyperloft 100 g/m² insulation on the main body. The synthetic palm uses a Grip Control layer for good grip on poles and tools. NOTE. Help ensure the longevity of the Warmit'N by always removing it when working with bindings and skins.

WINTER GLOVES

Ref.	Product name	Sizes	Weight/Pair										
			Size	g									
3156	G PURE	XS-S-M-L-XL-XXL-XXXL	M	100	3.5	•	•	•	•	•	•	•	•
3324	G PURE WARM	XS-S-M-L-XL-XXL-XXXL	M	135	4.8	•	•	•	•	•	•	•	•



Black / Brown



Video



G HOT WOOL

3322

SKI MOUNTAINEERING, ALPINE SKIING, MOUNTAINEERING, ALPINISM

- Unique all mountain glove constructed from natural materials
- Very warm and exceptionally breathable
- 60% merino wool blend insulation
- Premium-quality goatskin on the palm and wear points for the right combination of dexterity, grip and durability
- Fingers with 'Dart Finger' construction without fourchettes between the fingers for great dexterity and comfort
- Thumb and index finger are touch screen compatible
- Elastic wrist leashes
- Cuff loops for pulling on the gloves
- Clippable hanging loops
- Low profile buckles for clipping gloves together

The G Hot Wool is a unique all mountain glove characterized by the use of natural materials that are designed to provide a high level of performance and naturally warm, dry temperature regulation with 60% merino wool blended insulation. The palm and wear point reinforcements use premium-quality goatskin for the right combination of dexterity, grip and durability. The G Hot Wool does not use a waterproof membrane so it has exceptional breathability. The fingers are shaped using 'Dart Finger' construction that allows them to be formed with a minimal number of seams for very natural feeling anatomical fit.

G HOT WOOL LADY

3323

LADY

SKI MOUNTAINEERING, ALPINE SKIING, MOUNTAINEERING, ALPINISM



Black / Violet



Video



- Unique all mountain glove constructed from natural materials with a fit and profiling specifically designed for women
- Very warm and exceptionally breathable
- 60% merino wool blend insulation
- Premium-quality goatskin on the palm and wear points for the right combination of dexterity, grip and durability
- Fingers with 'Dart Finger' construction without fourchettes between the fingers for great dexterity and comfort
- Thumb and index finger are touch screen compatible
- Elastic wrist leashes
- Cuff loops for pulling on the gloves
- Clippable hanging loops
- Low profile buckles for clipping gloves together

The G Hot Wool Lady features a fit and profiling specifically designed for women. It is a unique all mountain glove characterized by the use of natural materials that are designed to provide a high level of performance and naturally warm, dry temperature regulation with 60% merino wool blended insulation. The palm and wear point reinforcements use premium-quality goatskin for the right combination of dexterity, grip and durability. The G Hot Wool does not use a waterproof membrane so it has exceptional breathability. The fingers are shaped using 'Dart Finger' construction that allows them to be formed with a minimal number of seams for very natural feeling anatomical fit.

Ref.	Product name	Sizes	Weight/Pair		🌡️	🔄	💧	🔄	👤	👤	👤	👤	👤	👤	👤	👤	👤
			Size	g													
3322	G HOT WOOL	S-M-L-XL-XXL-XXXL	M	150	5.3	4	•	•	•	•	•	•	•	•	•	•	•
3323	G HOT WOOL LADY	XS-S-M-L	S	135	4.8	4	•	•	•	•	•	•	•	•	•	•	•



Black

G LITE WIND

2830

MOUNTAINEERING, SKI MOUNTAINEERING, TREKKING, LIFESTYLE

- Fast-drying stretch fleece gloves with a windproof membrane
- Reinforcements on the palm and thumb
- Silicone Grip'R pads on middle, ring and pinky fingers for extra grip
- Fingers with 'Roll Finger' construction combines with fourchettes between the fingers for great dexterity and fit
- Thumb and index finger are touch screen compatible
- Elastic wrist leashes
- Clippable hanging loops
- Low profile buckles for clipping gloves together

The G Lite Wind is an extremely breathable stretch fleece windproof glove with silicone Grip'R pads on the fingers to assist with grip and conductor pads on the thumb and index finger to work with touch phones or tablets.



Grey

G WOOL

3155

MOUNTAINEERING, TREKKING, LIFESTYLE

- Wool/synthetic blend knitted glove
- Soft, durable goatskin palm and fingers
- Fingers with 'Roll Finger' construction combines with fourchettes between the fingers for great dexterity and fit
- Elastic wrist leashes
- Low profile buckles for clipping gloves together

The G Wool is a classic wool glove with technical performance features like the synthetic blend in the knit and goatskin palms and fingers for good grip and durability. The casual fit and classic aesthetic make it perfect for everyday use in mountain environments.



Video

Ref.	Product name	Sizes	Weight/Pair											
			Size	g										
2830	G LITE WIND	XS-S-M-L-XL-XXL	M	85	3.0	1	•	•	•	•	•	•	•	•
3155	G WOOL	XS-S-M-L-XL-XXL	M	115	4.1	2								•



Black / Lime

G AIR 2834

BEST SELLER



SKI MOUNTAINEERING, MOUNTAINEERING, TREKKING, LIFESTYLE

- Hyperlight gloves designed for maximum precision during intense aerobic activity
- Windproof main body features PrimaLoft® Gold 60 g/m² insulation
- Breathable palm
- Silicone Grip'R pads on the palm and fingers for exceptional grip
- Precision fit guarantees maximum sensitivity
- Fingers with 'Roll Finger' construction combines with fourchettes between the fingers for great dexterity and fit
- Thumb and index finger are touch screen compatible
- Elastic wrists for a precise fit
- Elastic wrist leashes
- Clippable hanging loops
- Low profile buckles for clipping gloves together

The G Air is a hyperlight glove designed for technical aerobic activities in the cold. The precision fit guarantees maximum sensitivity. The main body is windproof for protection from the elements while the palm remains unlined for breathability. PrimaLoft® Gold 60 g/m² insulation delivers a basic level of dry warmth while maintaining a high level of breathability. Silicone Grip'R pads on the palm and fingers for exceptional grip.



Black / Fuchsia

G AIR LADY 3399

BEST SELLER

LADY



SKI MOUNTAINEERING, MOUNTAINEERING, TREKKING, LIFESTYLE

- Hyperlight gloves designed for maximum precision during intense aerobic activity
- Designed specifically for women
- Windproof main body with PrimaLoft® Gold 60 g/m² insulation
- Breathable palm
- Silicone Grip'R pads on the palm and fingers for exceptional grip
- Precision fit guarantees maximum sensitivity
- 'Roll Finger' construction combines with fourchettes between the fingers for great dexterity and fit
- Thumb and index finger are touch screen compatible
- Elastic wrists for a precise fit
- Elastic wrist leashes
- Clippable hanging loops
- Low profile buckles for clipping gloves together

The G Air designed specifically for female hands. The G Air Lady is a hyperlight glove designed for technical aerobic activities in the cold. The precision fit guarantees maximum sensitivity. The main body is windproof while the palm remains unlined for breathability. PrimaLoft® Gold 60 g/m² insulation delivers a basic level of dry warmth while maintaining a high level of breathability. Silicone Grip'R pads on the palm and fingers for exceptional grip.



Ref.	Product name	Sizes	Weight/Pair			🌡️	🌀	💧	🔄	👉	👉	👉	👉	👉	👉	👉	PRIMALOFT
			Size	g	oz												
2834	G AIR	XS-S-M-L-XL-XXL-XXXL	M	60	2.1	2	•	•	•	•	•	•	•	•	•	•	•
3399	G AIR LADY	XS-S-M-L	S	55	1.9	2	•	•	•	•	•	•	•	•	•	•	•



G AIR HOT DRY

3151

SKI MOUNTAINEERING, MOUNTAINEERING, ALPINISM



Black / Orange



Video

- Extremely versatile glove for a high level of protection from the cold and from the elements during intense aerobic activity
- DRYZONE® waterproof/breathable membrane
- PrimaLoft® Gold 160 g/m² insulation on the main body and PrimaLoft® Gold 100 g/m² on the palm
- Silicone Grip'R pads on the palm and fingers for exceptional grip
- Precision fit guarantees maximum sensitivity
- 'Roll Finger' construction combines with fourchettes between the fingers for great dexterity and fit
- Thumb and index finger are touch screen compatible
- Elastic wrists for a precise fit
- Elastic wrist leashes
- Cuff loops for pulling on the gloves
- Clippable hanging loops
- Low profile buckles for clipping gloves together

The G Air Hot Dry is a warm and waterproof glove designed for cold weather aerobic activities. PrimaLoft Gold 160 g/m² insulation on the main body and PrimaLoft® Gold 100 g/m² insulation on the palm combines with the DRYZONE® waterproof/breathable membrane for a high level of protection from moisture, wind and the cold. Construction with super light materials is very anatomical for a high level of sensitivity that allows for precision maneuvers without removing the gloves. Silicone Grip'R pads on the palm and fingers for exceptional grip.



G AIR CORE

3398

SKI MOUNTAINEERING, MOUNTAINEERING, ALPINISM



Black / Red



- The warmest gloves in the G Air range with extra insulation for even colder conditions
- DRYZONE® waterproof/breathable membrane
- PrimaLoft® Gold 233 g/m² insulation on the main body and 133 g/m² on the palm
- Silicone Grip'R pads on the palm and fingers for exceptional grip
- Precision fit guarantees maximum sensitivity
- Fingers with 'Roll Finger' construction combines with fourchettes between the fingers for great dexterity and fit
- Thumb and index finger are touch screen compatible
- Elastic wrists for a precise fit
- Elastic wrist leashes
- Cuff loops for pulling on the gloves
- Clippable hanging loops
- Low profile buckles for clipping gloves together

Following in the footsteps of the popular G Air and G Air Hot Dry, the G Air Core features the same precision fit and lightweight materials with more insulation to handle even colder conditions. PrimaLoft® Gold 233 g/m² insulation on the main body and PrimaLoft® Gold 133 g/m² insulation on the palm combines with the DRYZONE® waterprooffe/breathable membrane for a high level of protection from moisture, wind and cold. Construction is very anatomical for a high level of sensitivity that allows for precision maneuvers without removing the gloves. Silicone Grip'R pads on the palm and fingers for exceptional grip. With the extra insulation, the G Air Core maintains a high level of loft that allows these lightweight gloves to perform in particularly cold conditions making them ideal for a variety of winter activities from mountaineering to ski touring and trekking.

Ref.	Product name	Sizes	Weight/Pair												
			Size	g											
3151	G AIR HOT DRY	XS-S-M-L-XL-XXL-XXXL	M	105	3.7	3	•	•	•	•	•	•	•	•	•
3398	G AIR CORE	XS-S-M-L-XL-XXL-XXXL	M	120	4.2	4	•	•	•	•	•	•	•	•	•



G AIR B-MITT

3400

SKI MOUNTAINEERING, MOUNTAINEERING

- Medium weight mittens constructed from lightweight materials for a great blend of lightweight, packability and thermal insulation
- PrimaLoft® Gold 100 g/m² insulation on the main body and 60 g/m² on the palm
- Silicone Grip'R pads on the palm for extra grip
- Elastic wrists for a precise fit
- Elastic wrist leashes
- Low profile buckles for clipping gloves together
- Compact carrying bag included

The G Air B-Mitt is a medium weight mitten designed for ski mountaineering and other cold weather mountain activities. It uses the same lightweight materials as the G Air gloves for the same blend of hyperlight weight, packability and thermal insulation. Warmth is guaranteed with PrimaLoft® Gold 100 g/m² insulation on the back and PrimaLoft® 60 g/m² on the palm. Every element of the construction including the elasticized wrist is designed to be extremely packable making the G Air B-Mitt an essential piece of gear that can be carried in the pack without noticing it for those 'just in case' scenarios.



Black

G AIR HAT

3152

LIFESTYLE

- Technical trucker hat with visor and rear snap adjustment
- Features design aesthetics of the Air gloves with siliconized printing

A trucker hat designed to be worn in the mountains. It uses the same aesthetics as the Air gloves for a coordinated and technical look.



Ref.	Product name	Sizes	Weight/Pair												
			Size	g	oz										
3400	G AIR B-MITT	S-M-L-XL	M	70	2.5	3	•		•		•			•	•



Grey / Black

K WARM 2995

SKI MOUNTAINEERING, MOUNTAINEERING, TREKKING, LIFESTYLE, ALPINISM

- Insulated gloves constructed using unique 3-D knitting for next level ergonomics and flexibility
- DRYZONE® waterproof/breathable membrane
- PrimaLoft Gold 60 g/m² insulation both on main body and on the palm
- Microfleece lining for all-day comfort
- Silicone Grip'R pads on the palms for exceptional grip
- Fingers with 'Roll Finger' construction combines with fourchettes between the fingers for great dexterity and fit
- Thumb and index finger are touch screen compatible
- Elastic cuff for a performance fit
- Elastic wrist leashes
- Low profile buckles for clipping gloves together

The K Warm uses innovative 3-D knitting technology for a glove that delivers next level ergonomics, flexibility and performance. Features a DRYZONE® waterproof/breathable membrane and PrimaLoft Gold 60 g/m² insulation for a high level of protection from the elements. The inner is lined with microfleece for all-day comfort and silicone Grip'R pads on the palms provide exceptional grip.



Grey / Lime

K AIR 2996

SKI MOUNTAINEERING, MOUNTAINEERING, TREKKING, LIFESTYLE

- Light and breathable gloves constructed using unique 3-D knitting technology
- Windproof membrane is knitted into the main body material
- Perforated palm for maximum breathability
- Fingers with 'Roll Finger' construction combines with fourchettes between the fingers for great dexterity and fit
- Thumb and index finger are touch screen compatible
- Short elastic cuff for the best range of motion
- Elastic wrist leashes
- Low profile buckles for clipping gloves together

The K Air is a hyperlight glove designed to deliver a very natural fit and feel. 3-D knitting manufacturing technology results in a glove with the very best ergonomics, fit and dexterity. The perforated palm and knitted main body are extremely breathable, but the glove remains wind resistant apart from the palm with a membrane that is knitted into the material. The short cuff is a welcome feature for minimalist users who need gloves, but don't want to know they are even wearing them.

Ref.	Product name	Sizes	Weight/Pair									
			Size	g	oz							
2995	K WARM	XS-S-M-L-XL-XXL-XXXL	M	125	4.4	3	•	•	•	•	•	•
2996	K AIR	XS-S-M-L-XL-XXL-XXXL	M	75	2.6	2	•	•	•	•	•	•



AIR MITT EVO

3325

1ST CLASS



SKI MOUNTAINEERING, MOUNTAINEERING

- Lightweight insulated mitten with an opening in the palm that allows the mitten to be folded open when you need to use your fingers
- Integrated lightweight merino wool inner glove
- Small magnets hold the outer mitten in place when open
- Silicone Grip'R pads on the palms for exceptional grip
- Lightweight ripstop nylon fabric exterior
- Soft inner lining for extra insulation and better comfort
- PrimaLoft® Gold 100 g/m² insulation on main body and 60 g/m² on the palm
- Index fingers are touch screen compatible
- Elastic wrists for a precise fit
- Elastic wrist leashes
- Low profile buckles for clipping mittens together
- Carrying bag included

The Air Mitt Evo is a technical mitten designed specifically for winter aerobic activities. The merino wool inner glove is soft, lightweight and breathable. The mitten combines a lightweight ripstop nylon exterior with PrimaLoft® Gold 100 g/m² insulation on main body and PrimaLoft® Gold 60 g/m² on the palm. The opening in the palm allows the mitten to be folded open when you need to use your fingers and is held in place with a magnet so it does not flap around when it is open. Silicone Grip'R pads on the palms provide good grip and the index fingers on the gloves are touchscreen compatible.



TEMPEST MITT EVO

2989



SKI MOUNTAINEERING, MOUNTAINEERING, ALPINISM

- Insulated mittens that fold away to expose the fingers and thumb for technical maneuvers
- Small magnets hold the fold-away flaps in place when opened
- Palm is reinforced with synthetic fabric for extra grip and durability
- Lightweight ripstop nylon outer material with WR treatment
- Microfleece lining for warmth and comfort
- PrimaLoft® Gold 200 g/m² insulation on the main body, PrimaLoft® Gold 100 g/m² insulation on the palm, PrimaLoft Gold 160 g/m² on the thumb
- Open-Close system on the wrist can be operated with one hand – just pull on the Close side to snug it up and the Open side to release and open
- Sweat pads on the thumbs
- Elastic wrist leashes
- Low profile buckles for clipping mittens together
- Carrying bag included

The Tempest Mitt Evo is a lightweight insulated mitten that allows the fingers and thumb to be exposed quickly and easily with fold-away flaps. This brings the benefits of mittens to winter athletes who also need their fingers for technical maneuvers. Small magnets hold the fold-away flaps in place when they are opened. The outer material is lightweight and highly weather resistant and each part of the glove uses insulation that is optimized for the specific zone with PrimaLoft® Gold 200 g/m² insulation on the main body, PrimaLoft® Gold 100 g/m² insulation on the palm, PrimaLoft Gold 160 g/m² on the thumb. The Open-Close system on the wrist is easy to operate with one hand – just pull on the Close side to snug it up and the Open side to release and open. The palm is reinforced with synthetic fabric for good grip and durability and the microfleece lining ensures a high level of warmth and comfort.

Ref.	Product name	Sizes	Weight/Pair		🌡️	🌀	💧	⚖️	👉	👉	👉	👉	👉	👉	👉	
			Size	g												oz
3325	AIR MITT EVO	S-M-L-XL	M	105	3.7	3	•	•	•	•	•	•	•	•	•	•
2989	TEMPEST MITT EVO	S-M-L-XL	M	125	4.4	4	•	•	•	•	•	•	•	•	•	•



SUMMITT'N

2836

HIGH ALTITUDE, ALPINISM, SKI MOUNTAINEERING



- Technical mittens designed to deliver maximum protection from extreme cold and severe weather in the mountains
- Open-Close system on the wrist can be operated with one hand – just pull on the Close side to snug it up and the Open side to release and open
- DRYZONE® waterproof and breathable membrane for protection from moisture and wind
- 3D pre-shaped construction for a precise fit
- Soft and supple goatskin palms are grippy and durable
- PrimaLoft® Gold 500 g/m² insulation on the main body, PrimaLoft® Gold 200 g/m² insulation on the palm, and PrimaLoft® Gold 270 g/m² insulation on the thumb for the right level of insulation even in wet conditions
- Low profile buckles for clipping mittens together
- Carrying bag included

The Summitt'N is designed to deliver maximum protection from extreme cold and severe weather in the mountains with PrimaLoft® Gold 500 g/m² insulation on the main body, PrimaLoft® Gold 200 g/m² insulation on the palm and PrimaLoft® Gold 270 g/m² insulation on the thumb, combined with the DRYZONE® membrane that lines the entire glove for extra protection from moisture and wind. The palms are reinforced with goatskin inserts for good grip and durability. The simple and secure Open-Close system on the cuff maximizes thermal insulation by creating a solid seal against the jacket and can be easily closed or opened even while wearing gloves – just pull on the Close side to snug it up and the Open side to release and open.

HOTMITT'N

2837

HIGH ALTITUDE, ALPINISM, SKI MOUNTAINEERING



- Lightweight, packable windproof mittens with premium down insulation
- Soft inner lining for extra warmth and comfort
- 3D pre-shaped construction for a profiled fit
- Polyurethane palms for extra durability
- Open-Close system on the wrist can be operated with one hand – just pull on the Close side to snug it up and the Open side to release and open
- Low profile buckles for clipping mittens together
- Carrying bag included

Lightweight, compact insulated mittens designed for high-altitude mountaineering. The Hotmitt'N features premium down insulation for great warmth and good temperature regulation. The windproof fabric adds an extra layer of protection against the extreme conditions typical of the high peaks. The simple and secure Open-Close system on the cuff maximizes thermal insulation by creating a solid seal against the jacket and can be easily closed or opened even while wearing gloves – just pull on the Close side to snug it up and the Open side to release and open. Complete with stuff sack for tighter packability.

Ref.	Product name	Sizes	Weight/Pair											
			Size	g										oz
2836	SUMMITT N	S-M-L	M	175	6.2	5	•	•					•	•
2837	HOTMITT N	S-M-L	M	215	7.6	5	•		•					



Florian Riegler climbing the crux of "Stile di vita", his very hard multi-pitch (120 m, 8c) on the Dos Casina wall close to Arco, Italy © Bigwall Productions

PROMOTIONALS



LOGO CLAIM MALE T-SHIRT

0862

Sizes: S-M-L-XL



5 Black / White



6 Light Blue / White

PREMANA MALE T-SHIRT

3243

Sizes: S-M-L-XL



1 Anthracite Grey

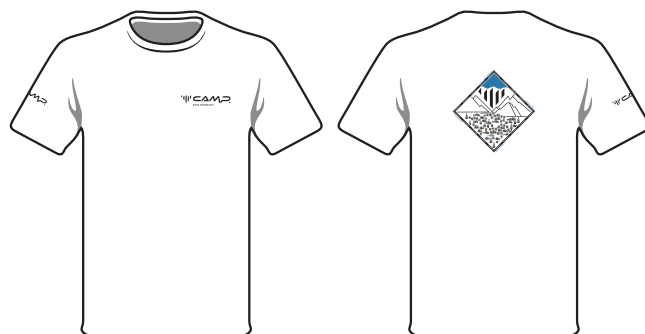

2 White

LOGO CLAIM FEMALE T-SHIRT

0863

LADY

Sizes: XS-S-M-L

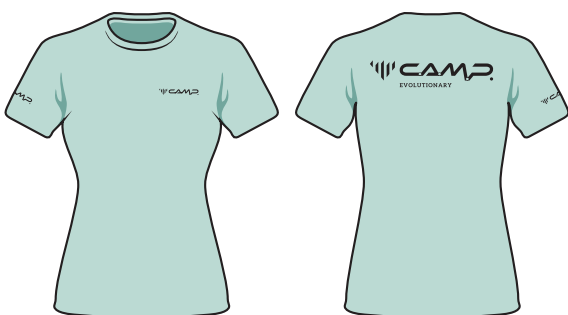

4 Pastel Green

PREMANA FEMALE T-SHIRT

3244

LADY

Sizes: XS-S-M-L



1 Black

HOODIE LOGO

2555

Sizes: XS-S-M-L-XL-XXL



3 Twilight Blue



4 Red

PROMO HAT LOGO

2553



3 Black / White

PREMANA HAT

3245



1 Black / Lime

CLASSIC PROMO HAT LOGO

3349



1 Black / White



4 Pastel Green / Black



2 Light Blue / Grey

PROMOTIONALS

MULTIPURPOSE BAND

3246



1 Black



2 Blue



3 Red

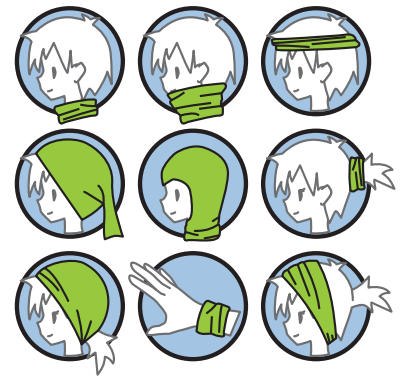

BOB BEANIE

295601 Dark Blue / Fuchsia
295602 Dark Blue / Light Blue



Dark Blue / Fuchsia



Dark Blue / Light Blue

TOM BEANIE

295801 Green



Green

JOE BEANIE

295701 Light Blue
295702 Green



Light Blue



Green

HEADBAND

295901 Black
295902 Green



Black



Green

SID HEADBAND

296002 Dark Blue



Dark Blue

PEAR

1107 50 mm
1105 60 mm
1106 80 mm



"D"

1100 50 mm
1102 60 mm
1104 70 mm



"D" LOCK

1499 60 mm
1344 70 mm
1424 80 mm



"D" WIRE GATE

1001 60 mm
1006 75 mm



C.A.M.P. Testimonials & Partners

CLIMBING-MOUNTAINEERING



Alessandro Baù
(Ita)



Yann Borgnet
(Fra)



Ludovico Fossali
(Ita)



Janja Garnbret
(Slo)



Stefano Ghisolfi
(Ita)



Iulia Kaplina
(Rus)



Luka Lindič
(Slo)



Tamara Lunger
(Ita)



Simone Moro
(Ita)



Ines Papert
(Ger)



Rob Pizem
(Usa)



Marcin Yeti
Tomaszewsky (Pol)



Denis Urubko
(Rus)

Allen Tyler (Usa)
 Angeloz Didier (Fra)
 Atkins Käthe (Ger)
 Bacci David (Ita)
 Bennett Scott (Usa)
 Belotserkovkiy Kirill (Kaz)
 Berlioz Matthieu (Fra)
 Bonhomme Paul (Fra)
 Bono Katie (Usa)
 Boucher Pierre (Fra)
 Campanelli Joey (Usa)
 Cararach Soler Roger (Spa)
 Carnati Stefano (Ita)
 Cesa Christian (Ita)
 Chambers Mike (Usa)
 Clavel Arnaud (Ita)
 Colli Beatrice (Ita)
 Cornamusini Alessio (Ita)
 Čujić Borna (Cro)
 De Jesús Martín Lucas (Spa)
 De Zaiacomio Matteo (Ita)
 Evans Kate (Usa)
 Flemming Jenn (Usa)
 Fowler Wes (Usa)
 García Marcus (Usa)
 Ghisolfi Claudia (Ita)
 Gianola Luca (Ita)
 Giglio Matteo (Ita)
 Girard Jean Francois (Can)
 Glazunov Evgeniy (Rus)
 González Álex (Spa)
 Grau Prat Josep (Spa)
 Gross Josh (Usa)
 Háček Zdeněk Háč (Cze)
 Hadley Nathan (Usa)

Herrington Blake (Usa)
 Huckaby Josh (Usa)
 Huey Jesse (Usa)
 Inoriza Mikel (Spa)
 Janin Rudi (Ita)
 Kempney Tyler (Usa)
 Lasagabaster Ander (Spa)
 Libera Rossano (Ita)
 Lichter Justin (Usa)
 Lochner Leonie (Ger)
 Matharan Paul (Fra)
 Marčić Nejc (Slo)
 Maureau Stéphanie (Fra)
 Messina Vittorio (Aut)
 Mirsky Dan (Usa)
 Montanari Luca (Ita)
 Morris Sarah (Usa)
 Mukhamedzyanov Ratmir (Rus)
 Nicolini Franco (Ita)
 Oprandi Omar (Ita)
 Osteyee Ian (Usa)
 Palmer Lena (Usa)
 Passini Luca (Ita)
 Peiró Jaume (Spa)
 Pérez Rafael Fernández (Spa)
 Porter Jed (Usa)
 Raether Andy (Usa)
 Ratti Francesco (Ita)
 Ravel Jean Francois (Fra)
 Reed Andy (Can)
 Riegler Florian (Ita)
 Riegler Martin (Ita)
 Rodríguez Doñate Belen (Spa)
 Rinn Michael (Ger)
 Roth Cody (Usa)

Rueck Ben (Usa)
 Sakulin Evgeniy (Rus)
 Salamanca Fernandez
 Angel Luis (Spa)
 Sauter Libby (Usa)
 Scarth-Johnson Angie (Aus)
 Segal Matt (Usa)
 Selak Gregor (Slo)
 Shapiro Jeff (Usa)
 Smiley Mark (Usa)
 Smith Nate (Usa)
 Snobeck Chris (Usa)
 Sorkin Madaleine (Usa)
 Sotnik Max (Rus)
 Steuer Lisi (Aut)
 Stitzinger Luis (Ger)
 Strazar Luka (Slo)
 Sumberg Sergey (Rus)
 Tardivel Pierre (Fra)
 Temerev Ivan (Rus)
 Tentori Simone (Ita)
 Tepfer Max (Usa)
 Thompson Joey (Usa)
 Tomatis Giorgio (Ita)
 Toth Kylee (Can)
 Virat Julia (Fra)
 Vachon Ryan (Usa)
 Von Melle Alix (Ger)
 Walsh Jon (Can)
 Warme Amity (Usa)
 Wörthl Michael (Ger)
 Welsted Ian (Can)
 Zariquiey Bibiana (Spa)
 Zumer Martin (Slo)

SKI MOUNTAINEERING



Robert Antonioli
(Ita)



Samantha Bertolina
(Ita)



William Boffelli
(Ita)



Lorna Bonnel
(Fra)



Nicolò Conclini
(Ita)



Matteo Eydallin
(Ita)



Giulia Murada
(Ita)



Federico Nicolini
(Ita)

Anderson Sierra (Usa)
 Baldini Rocco (Ita)
 Beccari Filippo (Ita)
 Compagnoni Giulia (Ita)
 DAV - Skimo Team
 Germany (Ger)
 Ellmenreich Baptiste (Fra)
 Felicetti Giorgia (Ita)
 Gaston John (Usa)
 Genot Clément (Fra)
 Giraud Matthias (Usa)
 Iratzoquy Marie-Charlotte (Fra)

LaRochelle Nikki (Usa)
 Martini Mara (Ita)
 Michelon Julien (Fra)
 Nicolini Elena (Ita)
 Oberbacher Alex (Ita)
 Polisportiva Albosaggia (Ita)
 Rice Aaron (Usa)
 Renoton Laurie (Fra)
 Rossi Giovanni (Ita)
 Sanelli Erika (Ita)
 Sanelli Mirko (Ita)
 Sbalbi Tony (Fra)

Sert Yoann (Fra)
 Sci Club Alta Valtellina (Ita)
 Sci Club Val Tartano (Ita)
 Shehan Joel (Usa)
 Smith Cameron (Usa)
 Sostizzo Matteo (Ita)
 Staberg Grace (Usa)
 Taam Max (Usa)
 Tomasoni Luca (Ita)
 Tomatis Katia (Ita)
 Veronese Ilaria (Ita)
 Young Jessie (Usa)

GROUPS

Access Fund (Usa)
 Alpine Club of Canada (Can)
 American Alpine Club (Usa)
 American Mountain Guides Association (Usa)
 Aspen Expeditions (Usa)
 Associazione Sportiva Premana (Ita)
 Colorado Mountain Club (Usa)
 Colorado Mountain School (Usa)
 Ensa - École Nationale des sports
 de montagne (Fra)
 Freek Guides (Spa)

GAFF4 - Groupe d'alpinisme au féminin (Fra)
 Gruppo Ragni della Grignetta (Ita)
 Guais del Picu (Spa)
 Guide alpine Bormio (Ita)
 Guide alpine Cortina (Ita)
 Guide alpine Mountain Dream (Ita)
 Mangia Trekking (Ita)
 Mazamas (Usa)
 Montania Outdoors (Spa)
 Sierra Mountain Guides (Usa)



© C.A.M.P. SpA - All rights reserved.

Photo credits: Ettore Zorzini, Bigwall Productions, Ines Papert, Veri Media, Giacomo Meneghelo, Claudio Migliorini, Klaus Fengler, Michele Caminati, Matteo Della Bordella, Paweł Hałdaś, Jakob Schweighofer / Red Bull Content Pool, Diego Borello, Sara Grippo, Michael Klekamp, Zdeněk Háček Háč

Product photos: C.A.M.P. SpA, 3D Visualcons

Cover photo: Alessandro Baù on "Eternal Flame" on Nameless in the Trango group, a spectacular granite obelisk of 6239 meters in the heart of Karakorum (Pakistan), climbed with Francesco Ratti and Leonardo Gheza © Ettore Zorzini

Graphic project: PrePrint - Lecco

Printing: printed in Italy, May 2023

GreenPrinting®



WARNINGS!

Activities for which C.A.M.P. products can be used are potentially dangerous.

It is the responsibility of the user to study and learn how to use this equipment properly. The weights indicated in this catalog may be subject to change due to manufacturing tolerance limits, to the integral nature of raw materials used, and to climate and storage conditions.

Products made of textile and plastic materials are more subject to weight variations.

Technical specifications of the products may change without notice. The content of this catalog may not be copied without font references and without written authorization of C.A.M.P. SpA.



Zdeněk Háček Háček, winner of the Piolet d'Or in 2020, and companions on the descent from the summit of Chumbu (6859 m) in Nepal, which had remained unclimbed until that day © Zdeněk Háček Háček



C.A.M.P. SpA
Costruzione Articoli Montagna Premana
Via Roma, 23 - 23834 Premana (LC) - Italy
Tel. +39 0341 890117
www.camp.it - contact@camp.it

C.A.M.P. USA Inc.
16050 Table Mountain Parkway #600
Golden, CO 80403
Tel.: +1 303 465 9429
www.camp.it/usa
outdoor@camp-usa.com

C.A.M.P. FRANCE SARL
1800, Avenue André Lasquin
74700 Sallanches
Tel. +33 04 50937405
www.camp.it/france
contact@campfrance.fr

филиал С.А.М.Р. спр в России
111024, г. Москва, ул. 2-я Кабельная, д. 2
тел. +7(800)500-15-69
www.camp-russia.ru
sales@camp-russia.ru

WORKBOOK 2024 OUTDOOR
Art. 348202 ENG



8 005436 132297